

# Bicycle Facility Design Guide

Version 2 - 2020

Washington, DC is a thriving city with a long history of world-class transportation facilities. While the District has always been committed to the development of a multimodal transportation network, the importance of bicycle facilities has grown in recent years as a means of sustainable, active, and equitable transportation. It is DDOT's goal to continue implementation of bicycle lanes throughout Washington, DC using the most currently available standards of industry practice.

This Guide serves as an update to the 2006 publication of the Bicycle Facility Design Guide. Since its original release, DDOT has continued to increase the implementation of bicycle facilities. The practices and standards described in this document reflect this as described herein.

*This page intentionally left blank.*

# Bicycle Facility Design Guide

## Version 2 - 2020

---

### Table of Contents

- 1 Introduction 1-1**
  - 1.1 Statement of Purpose..... 1-1
  - 1.2 Bicycle Facility Definitions ..... 1-1
    - 1.2.1 Shared Street 1-1
    - 1.2.2 Shared Lanes 1-2
    - 1.2.3 Dedicated Bicycle Lanes 1-3
    - 1.2.4 Buffered Bicycle Lanes 1-4
    - 1.2.5 Protected Bicycle Lanes 1-5
      - 1.2.5.1 Two-way Protected Bicycle Lanes 1-7
      - 1.2.5.2 Raised Two-way Protected Bicycle Lanes 1-8
    - 1.2.6 Contraflow Bicycle Lanes 1-8
    - 1.2.7 Advisory Bicycle Lanes 1-9
    - 1.2.8 Shared-Use Paths 1-10
  - 1.3 Bicycle Facility Selection..... 1-11
- 2 Geometric Configuration ..... 2-1**
  - 2.1 Lane Widths ..... 2-1
  - 2.2 Design Speed and Sight Distance ..... 2-2
    - 2.2.1 Sight Distance 2-3
  - 2.3 Pavement Design..... 2-3
    - 2.3.1 Raised Two-way Protected Bicycle Lane 2-3
    - 2.3.2 Shared-use Path 2-4
  - 2.4 Bicycle Facility Grade..... 2-4

2.5	Curb Cuts and Driveways.....	2-4
2.6	Storm Sewer Inlets/Grates .....	2-5
2.7	Accessible Passenger Loading Zones .....	2-6
<b>3</b>	<b>Pavement Markings and Channelizing Devices.....</b>	<b>3-1</b>
3.1	Longitudinal Markings .....	3-1
3.1.1	Dedicated Bicycle Lanes	3-1
3.1.2	Buffered Bicycle Lanes	3-1
3.1.3	Protected Bicycle Lanes	3-3
3.1.4	Two-way Protected Bicycle Lanes and Shared-use Paths	3-4
3.1.4.1	Protected Two-Way Bicycle Lanes	3-4
3.1.4.2	Raised Two-Way Bicycle Lanes	3-5
3.1.5	Contraflow Bicycle Lanes	3-6
3.1.6	Shared Bicycle/Transit Lanes	3-7
3.1.7	Advisory Bicycle Lanes	3-7
3.2	Channelizing Devices .....	3-8
3.3	Bicycle Facility Symbols .....	3-10
3.3.1	Bicycle Lanes	3-11
3.3.2	Shared Lanes	3-11
3.3.3	Shared Lanes with Transit	3-12
3.3.4	Intersection Bicycle Box	3-12
3.3.5	Two-Stage Turn Queue Box	3-13
3.3.6	Turn Pocket	3-15
3.4	Crossings .....	3-16
3.4.1	Intersection Crossing	3-16
3.4.2	Driveway Crossing	3-17
3.4.3	Bicycle Lanes at Vehicular Turn Lanes	3-18
3.4.4	Pedestrian Crossing	3-19



3.5	Bicycle Parking.....	3-19
3.5.1	Bicycle Racks	3-20
3.5.2	Bicycle Corral	3-21
3.5.3	Capital Bikeshare Station	3-21
<b>4</b>	<b>Intersection Treatments .....</b>	<b>4-1</b>
4.1	Intersection Treatment Selection .....	4-1
4.1.1	Overall Intersection Treatment	4-3
4.1.1.1	Through Lanes	4-3
4.1.1.2	Contraflow Bicycle Lanes	4-3
4.1.1.3	Bicycle Turning Movements	4-3
4.1.1.4	Protected Intersection	4-4
4.1.2	Treatments for Vehicular Turn Lanes	4-5
4.2	Intersection Typical Layout.....	4-6
4.3	Traffic Signal Operations .....	4-9
4.3.1	Intersection Phasing Selection	4-9
4.3.1.1	Two-way Bicycle Facilities	4-9
4.3.1.2	One-way Bicycle Facilities	4-9
4.3.1.3	Shared Bicycle Facilities	4-10
4.3.2	Bicycle Minimum Time	4-10
4.3.3	Bicycle Signal Head	4-12
4.3.4	Vehicular Right Turn on Red	4-13
4.4	Intersection Signage.....	4-13
4.4.1	General Signage	4-13
4.4.2	Two-Stage Turn Queue Box Signage	4-14
4.4.3	Turn Pocket Signage	4-14
4.4.4	Contraflow and Two-way Bicycle Traffic	4-14

<b>5</b>	<b>Bicycle Facilities and Transit .....</b>	<b>5-1</b>
5.1	Transit Stops .....	5-1
5.1.1	Dedicated Bicycle Lane Transit Stop	5-1
5.1.2	Shared Bicycle Lane Transit Stop	5-2
5.1.3	Protected-Shared Transit Stop	5-2
5.1.3.1	Bus Boarding Island	5-2
5.1.3.2	Shared Boarding Zone	5-4
5.2	Shared-use Bicycle/Transit Facility.....	5-9
5.2.1	Right Turn Lanes	5-10
<b>6</b>	<b>Typical Design Configurations .....</b>	<b>6-1</b>
6.1	Shared Street and Contraflow Bicycle Lanes.....	6-3
6.2	Dedicated Bicycle Lanes .....	6-4
6.3	Buffered Bicycle Lanes (Parking Side).....	6-5
6.4	Protected Bicycle Lanes .....	6-6
6.4.1	Without Parking	6-6
6.4.2	With Parking	6-7
6.5	Two-way Protected Bicycle Lanes .....	6-8
6.5.1	On Roadway	6-8
6.5.2	Off Roadway	6-9
6.6	Shared-use Bicycle/Transit Facility.....	6-10
6.7	Advisory Bicycle Lanes .....	6-11

## List of Tables

Table 1  Facility Treatment Selection Matrix.....	1-12
Table 2  Bicycle Lane Preferred and Minimum Widths .....	2-2
Table 3  Channelizing Device Selection Matrix.....	3-9
Table 4  Shared Lane Marking Volume Thresholds .....	3-12
Table 5  Intersection Treatment Decision Matrix.....	4-2
Table 6  Permissive Turn Thresholds .....	4-9

## List of Figures

Figure 1  Shared Street along the Southwest Waterfront .....	1-2
Figure 2  Shared Lanes on R Street NE.....	1-3
Figure 3  Designated Bicycle Lane on R Street NW.....	1-4
Figure 4  Buffered Bicycle Lane in Thomas Circle NW.....	1-5
Figure 5  Protected Bicycle Lane on M Street NW.....	1-6
Figure 6  Two-way Protected Bicycle Lane on 15 <sup>th</sup> Street NW.....	1-7
Figure 7  Raised Two-way Protected Bicycle Lane in the Southwest Waterfront.....	1-8
Figure 8  Shared Lane and Contraflow Bicycle Lane on 42 <sup>nd</sup> Street NW in Friendship Heights.....	1-9
Figure 9  Advisory Bicycle Lane on E Street SE.....	1-10
Figure 10  Shared-use Path on MET Branch Trail.....	1-11
Figure 11  Acceptable Storm Inlet Grate Designs.....	2-5
Figure 12  Vane Grate Installation.....	2-6
Figure 13  Accessible Passenger Loading Zone (Far Side) .....	2-7
Figure 14  Accessible Passenger Loading Zone (Mid-Block) .....	2-7
Figure 15  Dedicated Bicycle Lanes .....	3-1
Figure 16  Buffered Bicycle Lanes (Along Curb) .....	3-2
Figure 17  Buffered Bicycle Lanes (Parking Buffer).....	3-2
Figure 18  Protected Bicycle Lanes.....	3-3
Figure 19  Protected Bicycle Lanes (with Parking).....	3-4
Figure 20  Protected Two-Way Bicycle Lane.....	3-5
Figure 21  Raised Two-Way Bicycle Lane.....	3-6

Figure 22  Contraflow Bicycle Lanes .....	3-7
Figure 23  Advisory Bicycle Lanes.....	3-8
Figure 24  Figure 9C-3 (Excerpt) from the MUTCD, Element B: Helmeted Bicyclist Symbol.....	3-10
Figure 25  Shared Lane Marking .....	3-11
Figure 26  Shared Bicycle Transit Lane Marking Spacing .....	3-12
Figure 27  Intersection Bicycle Box on M Street NW .....	3-13
Figure 28  Two-stage Turn Queue Box on 4 <sup>th</sup> Street SW at Jefferson Drive SW .....	3-14
Figure 29  Bicycle Turn Pocket Approach of Pennsylvania Avenue NW at 13 ½ Street NW .....	3-16
Figure 30  Intersection Crossing along L'Enfant Plaza SW.....	3-17
Figure 31  Protected Bicycle Lane at Driveway.....	3-18
Figure 32  Right-Turn Mixing Zone/Combined Right-Turn Lane.....	3-19
Figure 34  Example of U-shape Bicycle Rack .....	3-20
Figure 35  Example of Ring-Style Bicycle Rack.....	3-20
Figure 35  Protected Intersection .....	4-5
Figure 36  Dedicated Right Turn Lane and Bicycle Through Lane on M Street NW .....	4-6
Figure 37  Protected Bicycle Lane on Collector at Shared Local Street .....	4-7
Figure 38  Protected Bicycle Lanes on Collector at One-Way Arterial with Two-Way Protected Bicycle Lanes.....	4-8
Figure 40  R10-15R (mod) Stop for Ped-Bike Sign .....	4-13
Figure 40  Bicycle Turn Pocket Signs.....	4-14
Figure 41  MUTCD R10-10b Regulatory Sign.....	4-15
Figure 43  Contraflow Bicycle Lane Warning Assemblies: W11-1 and W16-5(mod).....	4-16
Figure 43  Curbside Transit Stop with Dedicated Bicycle Lane .....	5-1
Figure 44  Bus Boarding Island on 14 <sup>th</sup> Street NW.....	5-3
Figure 45  Bus Boarding Island .....	5-4
Figure 46  Bus Boarding Island (Raised Protected Bicycle Lane).....	5-4
Figure 47  Shared Bicycle Lane Transit Stop.....	5-7
Figure 48  Shared Boarding Zone.....	5-8
Figure 49  Shared-use Bicycle/Transit Lane on H Street NW.....	5-9
Figure 50  Shared Bicycle Transit Lanes.....	5-10
Figure 52  R4-4 (mod) Sign.....	5-10

# 1 Introduction

## 1.1 Statement of Purpose

The District Department of Transportation (DDOT) *Bicycle Facility Design Guide – Version 2* serves as an update to the original guide published in 2006. Since its original publication, much has changed in the realm of bicycle facility design. DDOT has also expanded the City’s bicycle master plan to meet the growing demand of bicycle travel as a primary means of transportation.

The guidelines presented in this document are based on the *Manual on Uniform Traffic Control Devices* (MUTCD), the American Association of State Highway and Transportation Officials (AASHTO) *Guide for the Development of Bicycle Facilities*, the Federal Highway Administration (FHWA) *Separated Bike Lane Planning and Design Guide*, and the National Association of City Transportation Officials (NACTO) *Urban Bikeway Design Guide* and *Urban Street Design Guide*. These guidelines also reference and adhere to the 2019 publication of the DDOT *Design and Engineering Manual*.

In 2020, DDOT has embarked on a plan to build over 20 miles of new bicycle lanes over the next three years. This plan will further build a network of bike lanes that will allow more people to access a low-stress and efficient bicycling experience. This guide will aid in the consistent design and deployment of these facilities.

## 1.2 Bicycle Facility Definitions

The following section presents the industry-standard definitions for different types of bicycle facilities. While each facility is distinct and varies in purpose, they are generally presented in order of increasing protection and safety for bicycle users.

### 1.2.1 Shared Street

A shared street is a residential or commercial environment in which pedestrian or bicyclist activity is high and vehicular traffic volume is low. A shared street usually does not include pavement markings to separate these modes and is typically narrow in width or provides limited vehicular access to discourage high speeds. Often, shared streets include no curb and gutter or have sloping or mountable curbs

towards the edge of the right-of-way. The speed limit of shared streets is usually limited to 15 mph or less.



**Figure 1** | Shared Street along the Southwest Waterfront

### 1.2.2 Shared Lanes

A shared lane is a vehicular roadway facility, which includes shared lane markings within the travel way. Shared lane markings, or “sharrows,” are road markings used to indicate a shared lane environment for bicycles and automobiles. The shared lane marking is a pavement marking with a variety of uses to support a complete bikeway network; it is *not* a facility type and should not be considered a substitute for dedicated bicycle lanes, protected bicycle lanes, or other separation treatments where these types



of facilities are otherwise warranted or space permits.<sup>1</sup> Note that shared lanes should only be present when both the posted speed limit of the roadway and vehicular traffic volumes are lower.



**Figure 2 |** Shared Lanes on R Street NE

### 1.2.3 Dedicated Bicycle Lanes

A dedicated bicycle lane is an exclusive facility for bicyclists that is located within or directly adjacent to the roadway. It is located at the same grade as vehicular travel lanes, without any additional separation between vehicle and bicycle users. This type of facility is also known as a conventional bicycle lane or simply a bicycle lane.

---

<sup>1</sup> NACTO *Urban Bikeway Design Guide*





**Figure 3** | Designated Bicycle Lane on R Street NW

#### **1.2.4 Buffered Bicycle Lanes**

Buffered bicycle lanes are similar to dedicated bicycle lanes, but also include a flush-surface lateral separation distance from vehicular traffic. These facilities are located at the same grade as vehicular traffic and may include additional striping or hatching to emphasize the buffer. Buffered bicycle lanes may be located between vehicular travel lanes and vehicular parking lanes.





**Figure 4** | Buffered Bicycle Lane in Thomas Circle NW

### 1.2.5 Protected Bicycle Lanes

Protected bicycle lanes are bikeways that are at street level and that are physically separated from motor vehicle traffic with a vertical element.<sup>2</sup> This configuration is similar to a buffered bicycle lane that includes physical, vertical separation elements within the buffer. Examples of vertical separation elements include bollards, wheel stops, or a vehicular parking lane.<sup>3</sup> The preferred location of a protected bicycle lane is adjacent to the right-side curb when facing the direction of travel. This type of facility is also known as a protected bicycle lane or a one-way cycle track.

---

<sup>2</sup> FHWA *Separated Bike Lane Planning and Design Guide*

<sup>3</sup> NACTO *Urban Bikeway Design Guide*



**Figure 5 |** Protected Bicycle Lane on M Street NW

Protected bicycle lanes may accommodate one-way or two-way bicycle traffic and be located at street level or at the level of the sidewalk. The preferred location of a two-way protected bicycle lane will also vary based on the adjoining roadway facility. If adjacent to a one-way vehicular facility, the two-way protected bicycle lane may be located along the left curb when facing the vehicular direction of travel, particularly if bus transit service is provided in the adjacent vehicular lanes. If located along a two-way



vehicular facility, the bicycle facility location will depend on the location of adjoining bicycle facilities or presence of major driveways to simplify turning movements to and from these intersections or other conflicts. Further descriptions of each are provided below.

### 1.2.5.1 Two-way Protected Bicycle Lanes

A two-way protected bicycle lane is an exclusive bike facility that combines the user experience of a shared-use path with the on-street infrastructure of a protected bike lane. This type of facility is physically separated from motor traffic and distinct from the pedestrian sidewalk.<sup>4</sup> Note that this type of facility is sometimes referred to as a cycle track.



**Figure 6 |** Two-way Protected Bicycle Lane on 15<sup>th</sup> Street NW

---

<sup>4</sup> NACTO *Urban Bikeway Design Guide*

### 1.2.5.2 Raised Two-way Protected Bicycle Lanes

A two-way protected bicycle lane may be located at sidewalk elevation as long as it is physically separate and visually distinct from both the vehicular travel way and pedestrian space. In cases where the facility is located at the same grade as the sidewalk, it is also often referred to as a raised cycle track.

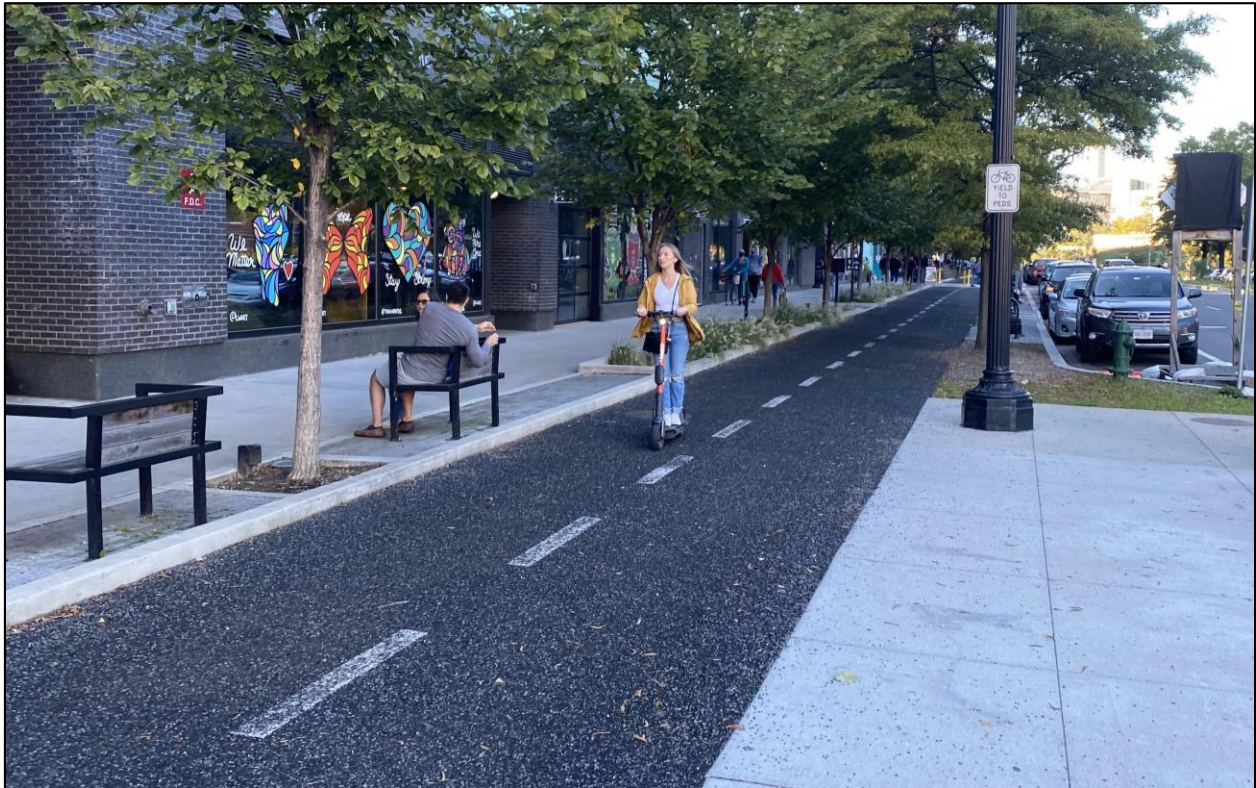

**Figure 7 |** Raised Two-way Protected Bicycle Lane in the Southwest Waterfront

### 1.2.6 Contraflow Bicycle Lanes

Contraflow bicycle lanes are bicycle facilities designed to allow bicyclists to ride in the opposite direction of motor vehicle traffic on a one-way traffic street. They convert an existing one-way street into a two-way street: one direction for motor vehicles and bikes, and the other for bikes only.<sup>5</sup> Usually a contraflow bicycle lane is paired with an opposing shared lane to add two-way bicycle flow to a one-way vehicular facility. The preferred location of a contraflow bicycle lane is adjacent to the right-side curb when facing the bicycle direction of travel. If paired with an opposing shared lane, the contraflow lane

<sup>5</sup> NACTO *Urban Bikeway Design Guide*



should be placed in the uphill direction of travel (with the shared lane in the downhill direction). This configuration is often referred to as a “climbing lane.”



**Figure 8** | Shared Lane and Contraflow Bicycle Lane on 42<sup>nd</sup> Street NW in Friendship Heights

### 1.2.7 Advisory Bicycle Lanes

Advisory Bike Lanes are currently an experimental treatment used within Washington, DC with permission from FHWA. The principal features are a dashed bike lane and a single shared vehicular lane for two-way travel ranging between 11' - 16' in width. This lane width is below the typical DDOT *DEM* minimum, and when opposing vehicular traffic encounters occur, one or both vehicles enter the dashed bike lane to pass one another. Due to the positioning of opposing vehicles, this design suggests drivers slow down for any passing. This pattern is currently used on two-way streets with parking between 35' and 48' in total width, and where speeding has been identified as a problem for the community. Full FHWA approval for use is possible in coming years.



**Figure 9 |** Advisory Bicycle Lane on E Street SE

### 1.2.8 Shared-Use Paths

A shared-use path is a multimodal facility that is physically separated from motor vehicle traffic by an open space or barrier and either within the highway right-of-way or within an independent right-of-way. The installation of these facilities come as a result of high vehicular volume (as indicated in **Table 1**) or in cases of limited right-of-way. These may also be appropriate as recreational facilities in parks or other green spaces.

Shared-use paths may be used by bicyclists, pedestrians, skaters, wheelchair users, joggers, and other non-motorized users. Most shared-use paths are designed for two-way travel. Note that for the purposes of this document, the terms “shared-use path” and “trail” are interchangeable and refer to a paved, off-road facility.



**Figure 10** | Shared-use Path on MET Branch Trail

### **1.3 Bicycle Facility Selection**

The selection and design of a bicycle facility treatment is based on a combination of factors, including the vehicular speed limit of the facility, Average Daily Traffic (ADT) volume on the facility, availability of right-of-way, the intent of the ultimate bicycle facility, impact on parking, the provision of transit service along the corridor, and with consideration of the existing DDOT 2016 Functional Classification System of roadways within the District. See **Table 1** for the appropriate facility selection based on these factors.

Additional information on the selection of bicycle facilities may be found in the FHWA *Bikeway Selection Guide* or the NACTO *Urban Bikeway Design Guide*.



**Table 1 | Facility Treatment Selection Matrix**

Speed Limit	Traffic Volume (vehicles per day)	Existing Facility Type	Existing Lane Configuration	Cross Section <sup>2</sup>	Preferred Treatment <sup>3</sup>	Alternative Treatment	Other Considerations
<15 mph	n/a	Shared Street <sup>1</sup>	n/a	Any	Shared Markings Additional Signs	None or Signs Only	<ul style="list-style-type: none"> <li>Roadway design should limit the vehicular speed</li> </ul>
<20 mph	<3,000	Local (neighborhood)	No Centerline Single Lane, One-way	<30'	No Markings	Shared Lane Marking Advisory Bicycle Lane	<ul style="list-style-type: none"> <li>Use a contraflow bicycle lane to establish bidirectional bicycle traffic on one-way streets</li> </ul>
≤25 mph	<500-1,500	Local (commercial)	One or Two Lanes Parking lane(s)	<34'	Shared Lane Marking	Advisory Bicycle Lane	<ul style="list-style-type: none"> <li>Locate Bicycle Lane between curb and parking lane with buffer for door swing clearance</li> <li>Use a contraflow bicycle lane to establish bidirectional bicycle traffic on one-way streets</li> </ul>
≤25 mph	<1,500-3,000	High-Volume Local	One or Two Lanes Parking lane(s)	<38'	Dedicated Bicycle Lane	Shared Lane Marking	<ul style="list-style-type: none"> <li>Consider pairing the facility with an adjacent one-way local road in the opposite direction</li> </ul>
≤25 mph	<3,000-9,000	Collector	Two Lanes Parking Lane(s)	<44'	Buffered Bicycle Lane or Protected Bicycle Lane <sup>4</sup>	Dedicated Bicycle Lane	<ul style="list-style-type: none"> <li>Locate Bicycle Lane between curb and parking lane with buffer for door swing clearance</li> <li>Use a contraflow bicycle lane or buffered bicycle lane to establish bidirectional bicycle traffic on one-way streets</li> </ul>
≤25 mph	<9,000-12,000	Collector – Multi-Lane	Two to Four Lanes Parking Lane(s) Peak Period Parking	<44'	Buffered Bicycle Lane or Protected Bicycle Lane <sup>4</sup>	Protected Bicycle Lane <sup>4</sup>	<ul style="list-style-type: none"> <li>Locate Bicycle Lane between curb and parking lane with buffer for door swing clearance</li> <li>If facility is one-way, create 2-directional pairing with adjacent one-way street</li> </ul>
≤30 mph	<12,000-15,000	Minor Arterial	Two to Four Lanes Parking Lane(s) Peak Period Parking	<50'	Protected Bicycle Lane <sup>4</sup>	Buffered Bicycle Lane	<ul style="list-style-type: none"> <li>Use an adjacent parking lane to provide enhanced bicycle facility buffer and protection if possible</li> </ul>
≤35 mph	>15,000	Principal Arterial	Two to Six Lanes Parking Lane(s) Peak Period Parking	>50'	Raised Protected Bicycle Lane	Protected Bicycle Lane <sup>4</sup>	<ul style="list-style-type: none"> <li>Consider dedicated bicycle facilities when motorized vehicle volume is high</li> </ul>

**References:** AASHTO *Guide for the Development of Bicycle Facilities, Fourth Edition Table 2-3*; DDOT DEM 30-12,30-13,30-14; NACTO *Urban Bikeway Design Guide, Contextual Guidance for Selecting All Ages & Abilities Bikeways*

**Notes:**

<sup>1</sup> Shared streets are not defined by the DDOT Design and Engineering Manual

<sup>2</sup> Cross section widths are provided as reference only. Actual application of a facility type is dependent on field conditions and should be discussed with the DDOT project manager.

<sup>3</sup> The preferred treatments indicated in the table represent the minimum preferred treatment for bicycle protection and accommodation. In locations where a continuous bicycle network is advantageous, a higher-class bicycle facility may be used for connectivity.

<sup>4</sup> Protected bicycle lanes may be one-way or two-way facilities, dependent on the overall bicycle network, available right-of-way, and other user access factors.



## 2 Geometric Configuration

Unless described within this document, the geometric design of bicycle facilities within the District of Columbia shall conform to the standards set by the 2019 DDOT *Design and Engineering Manual*, Chapter 29 and Chapter 30. Considerations and additional guidance are provided in this section.

For the purposes of this chapter, “bicycle lane” refers to the travel way dedicated to bicycle users, including those on dedicated bicycle lanes, buffered bicycle lanes, protected bicycle lanes, or two-way protected bicycle lanes.

### 2.1 Lane Widths

The preferred lane width for bicycle facilities is 6'. Per DDOT DEM 30.10.1 (Table 30-12 and 30-13), the minimum width of a bicycle lane is 5'. Note that when adjacent to a curb and gutter, a bicycle lane may be a minimum of 4' wide, not inclusive of gutter width since the gutter is not typically traversable by cyclists.<sup>6</sup> Vehicular travel lane requirements may be reduced by 1' when adjacent to bicycle lanes, to a minimum of 10' (except for Advisory Bicycle Lanes). In protected bicycle lanes, a 3' buffer width is preferred to accommodate hatching and channelizing devices. A minimum 18" width shall be maintained for all bicycle facility buffers. In cases of constrained right-of-way, exceptions to the buffer width may be used in discussion with the DDOT project manager.

For two-way protected bicycle lanes, widths are preferred to be at least 5' for each lane, totaling 10' for both directions. A 3' buffer separation between the bicycle lane(s) and vehicular travel lanes is preferred, with a minimum width of 18". In cases of constrained right-of-way, the lane widths for two-way protected bicycle facilities may be reduced to a minimum 4' in each direction. In this configuration, a 3' buffer with channelizing devices is required between the two-way bicycle lanes and the vehicular travel lanes, as the buffer provides additional maneuvering space for bicyclists. When a two-way bicycle facility is adjacent to a vehicular parking lane, a 3' buffer with channelizing devices is required in order to provide clearance from vehicle door swing (also known as “dooring”).

---

<sup>6</sup> NACTO *Urban Bikeway Design Guide*

If an existing roadway cross section with bicycle lanes has sufficient width to accommodate all necessary cross-sectional lanes and elements (vehicle lanes, bicycle lanes, buffer, and/or parking lanes), the remaining cross-section width should be allocated to buffer or median space. Vehicle lanes shall not be widened beyond 12' to account for the difference in cross-sectional width.

**Table 2 | Bicycle Lane Preferred and Minimum Widths**

Bicycle Lane Location	Bicycle Lane Width		Buffer Width		Notes
	Preferred	Minimum	Preferred	Minimum	
Typical	6'	5'	3'	18"	
Adjacent to curb/gutter	6'	4'	3'	18"	Bicycle Lane + Gutter Width must total minimum 5'
Between Vehicle Lane and Parking Lane (buffer along parking lane)	6'	4'	3'	3'	Bicycle Lane + Buffer must total minimum 7'
Two-way Protected Bicycle Lane	6'+6'	4'+4'	3'	18"	Two-way Bicycle Lane + Buffer must total minimum 11'
Two-way Protected Bicycle Lane adjacent to Parking Lane	6'+6'	4'+4'	3'	2'	Two-way Bicycle Lane + Buffer must total minimum 11'

**Note:** Vehicle Travel lane shall be a minimum of 10' wide when adjacent to a bicycle lane.

The typical configuration for an Advisory Bicycle Lane consists of 7' minimum (8' preferred) parking lanes adjacent to the curb, 5' Advisory Bicycle Lanes, and a single center vehicular lane which ranges in width from 11' to 16' (depending on available cross section).

## 2.2 Design Speed and Sight Distance

Sight distance for bicycle facility intersections with roadways, driveways, and other bicycle facilities is dependent on the facility design speed. The design speed for bicycle facilities is based on facility type and grade. An 18 mph design speed will cover most users based on the *AASHTO Guide for the Development of Bicycle Facilities*. In denser urban (such as downtown) and/or other recreational areas of the District, a lower design speed may be considered following discussion with DDOT staff.

### 2.2.1 Sight Distance

The Stopping Sight Distance (SSD) of a bicycle on 0% grade at an 18 mph design speed is approximately 135 feet (AASHTO *Guide for the Development of Bicycle Facilities*). For facilities with vertical grades in excess of 3%, see the AASHTO *Guide for the Development of Bicycle Facilities*, Chapter 5.2. Exact SSD may be calculated with the formula shown in **Equation 1**.<sup>7</sup>

**Equation 1** | Stopping Sight Distance

U.S. Customary		
$S = \frac{V^2}{30(f \pm G)} + 3.67V$		
where:		
S	=	stopping sight distance (ft)
V	=	velocity (mph)
f	=	coefficient of friction (use 0.16 for a typical bike)
G	=	grade (ft/ft) (rise/run)

The application of stopping sight distance for bicycle facilities should follow the procedures and methods outlined in the AASHTO *Guide for the Development of Bicycle Facilities*. Examples include providing sufficient sight triangles at intersections (particularly where the vehicular movement is uncontrolled) or motorist’s visibility of bicyclists around fixed obstacles.

## 2.3 Pavement Design

The majority of bicycle facilities in the District of Columbia are on the existing vehicular street network. As such, on-street pavement cross sections for bicycle facilities are unnecessary and are superseded by the vehicular requirements outlined in the DDOT DEM. Two unique cases for pavement design exist for off-road bicycle facilities: Raised Two-way Protected Bicycle Facilities and Shared-use Paths.

### 2.3.1 Raised Two-way Protected Bicycle Lane

When possible, all raised bicycle lane facilities should be constructed as a porous asphalt sidewalk, consistent with the DDOT DEM. Colorized pavement is not preferred for off-street facilities, but coloration may vary as a result of aggregate content. It is preferred that coloration similar to asphalt binder be maintained.

Raised Two-way Protected Bicycle Lane pavement design shall be consistent with that of pedestrian crossings at driveways. At roadway intersections, curb ramps should span the full width of the facility (not inclusive of side flares). When located on a sidewalk adjacent to a vehicular parking lane, a 5’ buffer

<sup>7</sup> AASHTO *Guide for the Development of Bicycle Facilities*, Table 5-4

shall be provided between the parking lane and the bicycle lane edge to allow for unconflicted vehicular door access.<sup>8</sup>

Note that pedestrian and bicycle traffic may be separated and designated using a Shared-use Path Restriction Sign (MUTCD R9-7), consistent with MUTCD Section 9B.12. This configuration should only be used when sufficient facility width is provided for both the two-way bicycle lane and pedestrian sidewalk to meet ADA and DDOT clear space requirements.

### **2.3.2 Shared-use Path**

Shared-use path facilities should be constructed as an asphalt sidewalk but may be constructed using porous asphalt. Trails should be designed to meet Department of Energy & Environment Stormwater requirements and consistent with the DDOT *DEM* 29.4.6.

At roadway intersections, shared-use path curb ramps shall span the full width of the facility, not inclusive of side flares (if used).

## **2.4 Bicycle Facility Grade**

A bicycle facility should maintain no more than 5% slope or match the existing roadway grade. On longer grades in excess of 5%, increase bicycle lane width to 7' to enable uphill bicyclists to dismount or downhill bicyclists greater maneuverability. Buffer width may be considered as part of the additional lane width as long as it is uninterrupted (i.e. without channelizing devices).

In cases of steep grade where uphill lanes are adjacent to a pedestrian sidewalk, the bicycle lane width may remain 5' if right-of-way is constrained. In cases of steep downhill lanes, an MUTCD W7-5 "Hill" bicycle warning sign may be posted at least 50' in advance of the condition.<sup>9</sup>

## **2.5 Curb Cuts and Driveways**

Intersections of driveways with bicycle facilities shall follow the sight distance requirements outlined in **Section 2.2**. For driveways intersecting with bicycle facilities that are located on the road, driveways shall conform to DDOT standard drawings.

---

<sup>8</sup> NACTO *Urban Bikeway Design Guide*

<sup>9</sup> MUTCD

Driveways are required to be flush with an intersecting raised protected bicycle lane, typically the same elevation as the sidewalk. However, driveways are not required to maintain the paving color and texture of the adjoining bicycle facility and should match that of the adjoining sidewalk instead, per the DDOT DEM.

## 2.6 Storm Sewer Inlets/Grates

Stormwater inlets shall be selected and installed to prevent bicycle wheels from getting caught or redirected. Grate type examples in an acceptable orientation are shown in **Figure 11**.

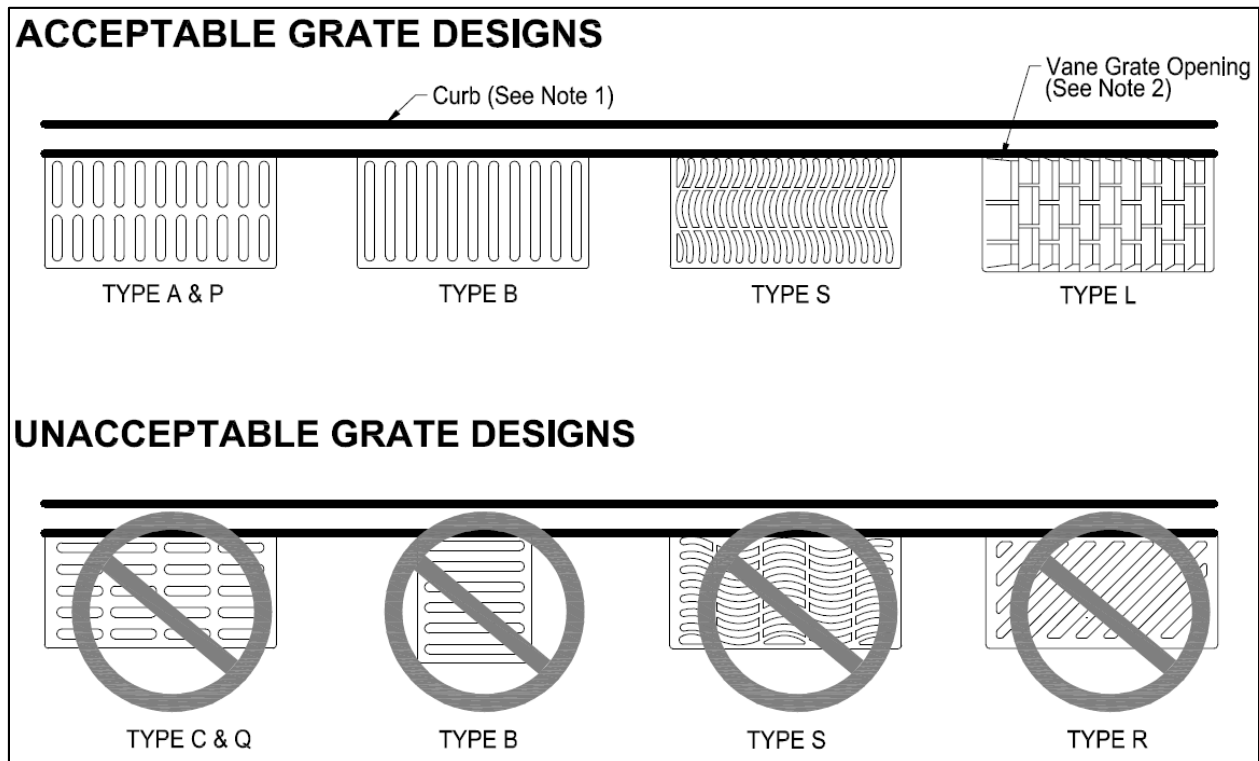

**Figure 11 |** Acceptable Storm Inlet Grate Designs

### Notes:

1. Grate types are only considered bicycle-safe with the curb orientation as shown.
2. Vane grate openings are desirable in locations where hydraulic capacity is needed. The grate must be oriented with the direction of flow as shown in **Figure 12**.
3. Grate types shown are based upon the Neenah Foundry model numbers. Other manufacturer grates may be installed if they meet the grate design specifications shown here.

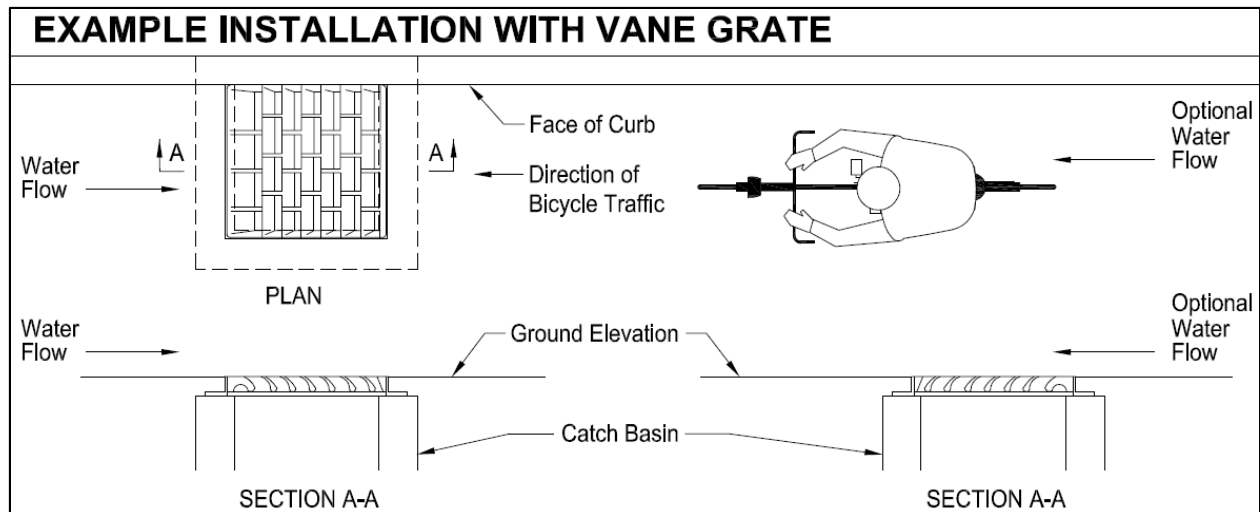

**Figure 12 |** Vane Grate Installation

## 2.7 Accessible Passenger Loading Zones

The installation of bicycle lanes shall not interfere with the on-going services of designated passenger loading zones (e.g., pick-up and drop-off at schools, hotels, hospitals, taxi stands, etc.). Any proposed design should implement the necessary modifications to allow the services of the passenger loading zones.

All designs for the passenger loading zones should comply with the Accessibility guidelines (2010 Americans with Disabilities Act Standards for Accessible Design or the Public Rights of Way Accessibility Guidelines [PROWAG]). Section R310 of the PROWAG and Section 503 of the ADA requires at least one accessible loading zone per 100 ft. of continuous loading zone space when passenger loading is provided.

At a minimum, the following elements should be included for a bicycle lane that crosses an existing passenger loading zones to ensure compliance with the ADA:

- Passenger loading zones signs
- Minimum of 60-foot length passenger loading zone
- 5-foot wide access aisle
- Connection to the pedestrian accessible route (sidewalk)
- Curb ramp to allow connection the sidewalk
- Crosswalk in the bicycle lane

When adjacent to a 5' access aisle at an accessible passenger loading zone, a bicycle lane should remain at a consistent width; however, it may narrow to 4 feet wide. If a bicycle lane is required to shift laterally or narrow in order to accommodate the 5' access aisle, the bicycle lane taper shall not be less than 3:1.

All pedestrian access routes to and from an accessible passenger loading zone which cross a bicycle facility shall be marked with crosswalk markings. Designated pedestrian crossings of the bicycle facility shall be marked similar to high-visibility crosswalks, with two 4", parallel solid white lines running perpendicular to bicycle flow. 1' wide and 1' skip solid white lines shall be placed between these lines, running parallel to the direction of flow.

See **Figure 13** and **Figure 14** for bicycle lane configuration examples at far-side and mid-block locations of accessible passenger loading zones, respectively.

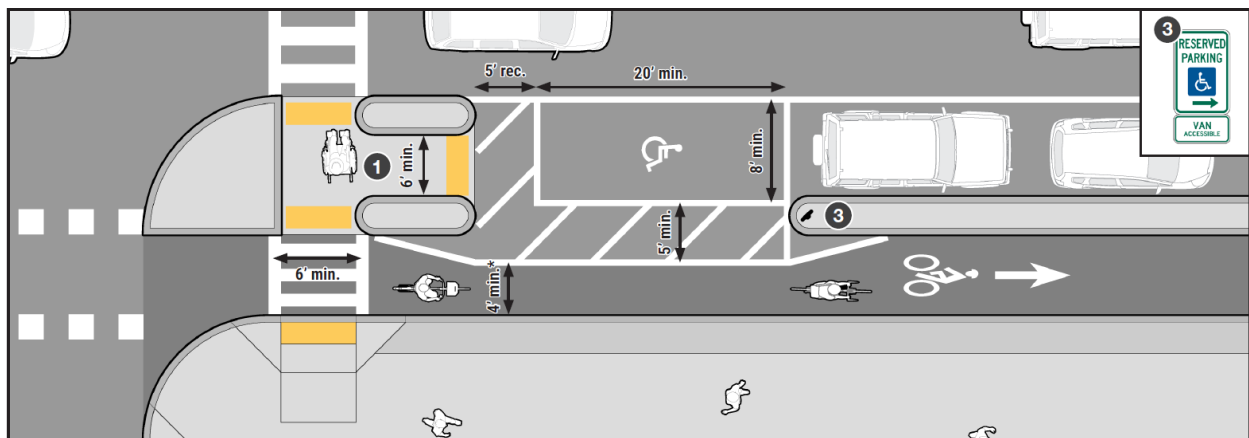

**Figure 13** | Accessible Passenger Loading Zone (Far Side)

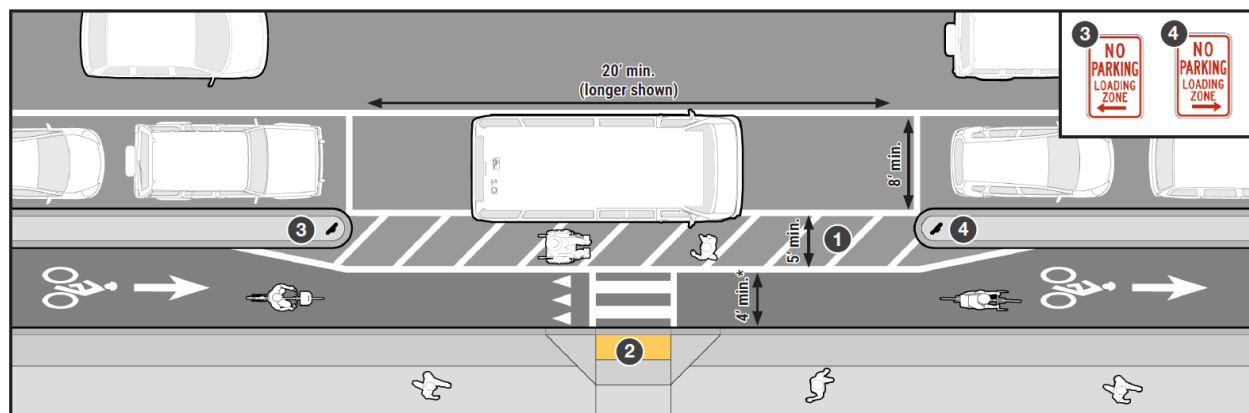

**Figure 14** | Accessible Passenger Loading Zone (Mid-Block)

Source: MassDOT Separated Bike Lane Planning & Design Guide

*This page intentionally left blank.*



## 3 Pavement Markings and Channelizing Devices

With the exception of green bicycle lane, green intersection crossing, or red shared bicycle-bus lane pavement coloration, all bicycle facility pavement markings shall be retroreflective.

### 3.1 Longitudinal Markings

Typical plan-view design configurations are indicated in each of the following sections. For further cross-section details, see **Chapter 6**.

#### 3.1.1 Dedicated Bicycle Lanes

Dedicated bicycle lanes are located adjacent to vehicular travel lanes. The lane line between vehicular traffic and the bicycle lane shall be a 6" solid white line. When located adjacent to the curb (or other road edge), the lane line between the bicycle lane and road edge shall be a 4" solid white line. A curb-side lane line is not required if a gutter pan is present.

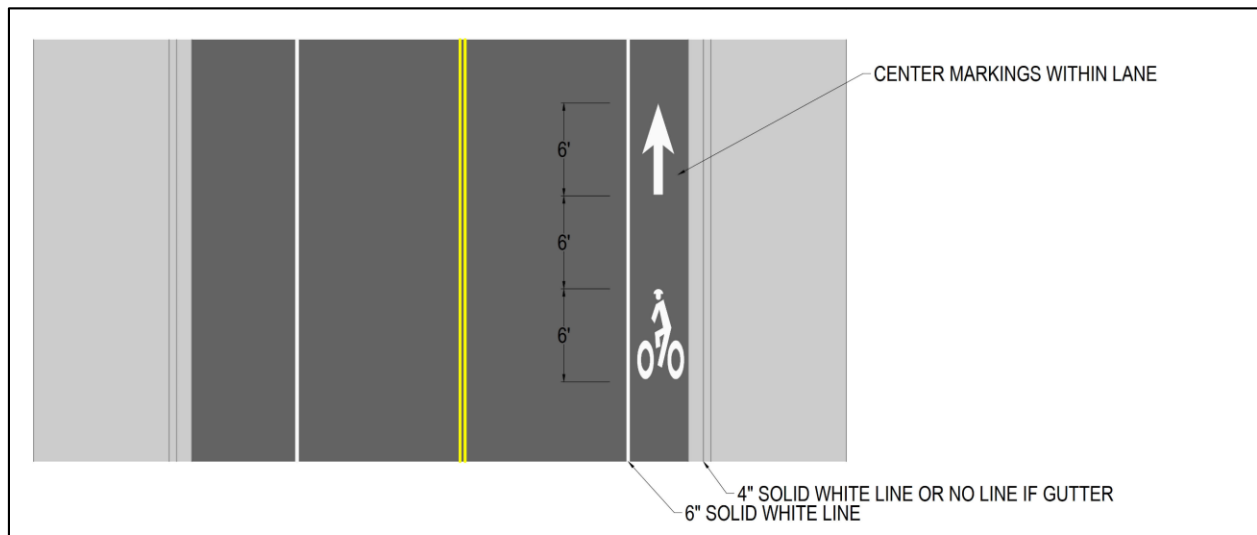

**Figure 15** | Dedicated Bicycle Lanes

#### 3.1.2 Buffered Bicycle Lanes

A flush-surface buffer is provided between buffered bicycle lanes and vehicular traffic. The buffer shall be a minimum of 18" wide, preferred 3'. The lane line between vehicular traffic and the buffer shall be a 4" solid white line. The lane line between the bicycle lane and buffer shall be a 4" solid white line. The buffer should be hatched with 4" solid white line chevrons spaced at 15'. The lane line between the

bicycle lane and the curb shall be a 4" solid white line. A curb-side lane line is not required if a gutter pan is present.

A buffered bicycle lane may be located between vehicular travel lanes and a vehicular parking lane (with buffer) or along the street curb. When located between a vehicular travel lane and a parking lane, a 3' buffer shall be added between the bicycle lane and the parking lane to provide adequate clearance for vehicle door swing and reduce the potential of bicycle-door conflicts (i.e. "dooring"). The lane line between the bicycle lane and parking lane or buffer shall be a 4" solid white line. The buffer shall not be hatched in this configuration.



**Figure 16 | Buffered Bicycle Lanes (Along Curb)**

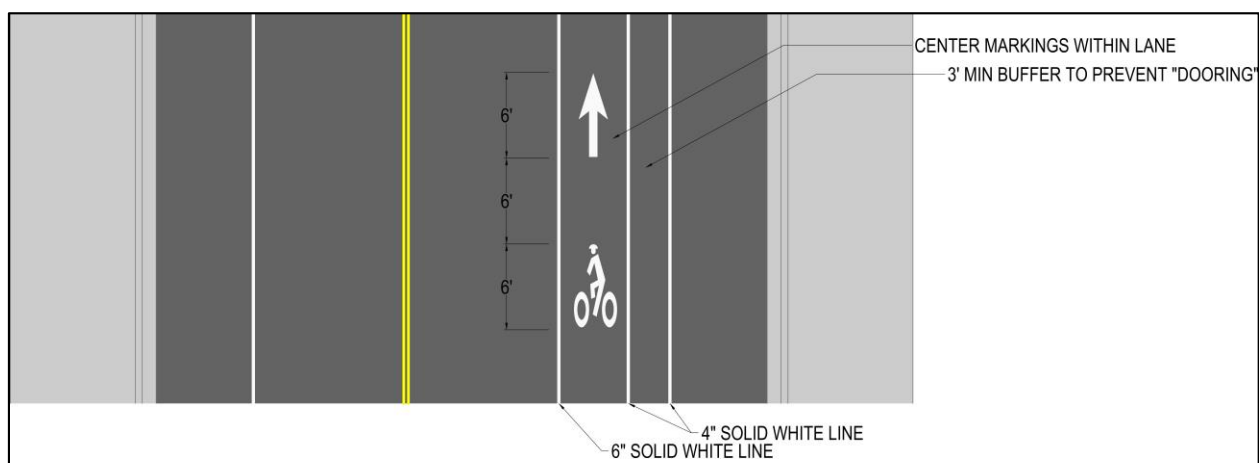

**Figure 17 | Buffered Bicycle Lanes (Parking Buffer)**

### 3.1.3 Protected Bicycle Lanes

Protected bicycle lanes are separated from vehicular travel lanes by a vehicular parking lane or a buffer with vertical elements. The lane line between vehicular traffic and the buffer shall be a 4" solid white line. The lane line between the bicycle lane and buffer shall be a 4" solid white line. The buffer should be hatched with 4" solid white line chevrons spaced at 15'. The buffer shall include vertical separation elements as described in **Section 3.2**, spaced consistently between chevrons (if present).

When located adjacent to the curb, the lane line between the protected bicycle lane at the road edge shall be a 4" solid white line. A curb-side lane line is not required if a gutter pan is present.

If a protected bicycle lane is located between a parking lane and the curb, a 3' buffer between the parking lane and bicycle lane shall be provided. A 4" solid white lane line is required between the parking lane and the bicycle lane and/or buffer.

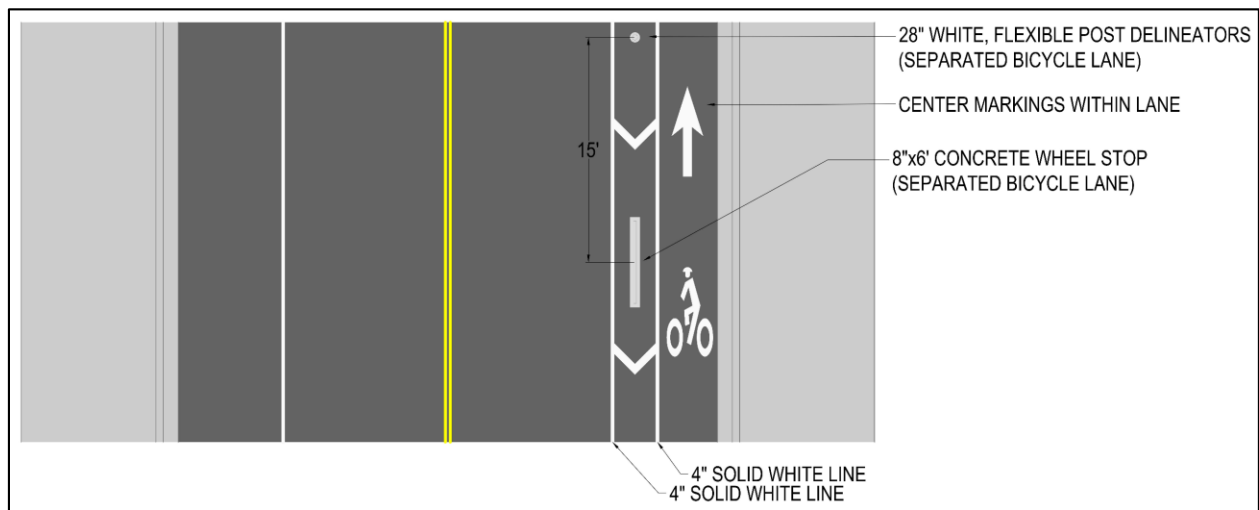

**Figure 18** | Protected Bicycle Lanes



**Figure 19** | Protected Bicycle Lanes (with Parking)

### 3.1.4 Two-way Protected Bicycle Lanes and Shared-use Paths

Where passing is permitted, a two-way protected bicycle lane or shared-use path shall have a 4" wide, 3' long dashed yellow centerline with 9' spaces.<sup>10</sup> In locations where passing is not permitted, and within 20' of an intersecting trail or roadway, a solid 4" yellow line shall be used.

Further requirements apply to two-way protected bicycle lanes depending on the use and type of an adjacent facility.

#### 3.1.4.1 Protected Two-Way Bicycle Lanes

A protected two-way bicycle lane refers to a facility which is located on an existing vehicular street. A buffer shall be provided between two-way protected bicycle lane and vehicular traffic. It shall be a minimum of 18" wide, preferred 3'. The lane line between vehicular traffic and the buffer shall be a 4" solid white line. The lane line between the bicycle lane and buffer shall be a 4" solid white line.

A concrete median or similar is preferred for long-term or permanent bicycle lane buffers. If flush with the road surface, the buffer shall be hatched with 4" solid white line chevrons spaced at 15'. The buffer shall include alternating vertical separation devices (flexible post delineators and wheel stops), spaced 7.5' apart between chevrons.

The lane line between the bicycle lane at the curb shall be a 4" solid white line. A curb-side lane line is not required if a gutter pan is present.

<sup>10</sup> MUTCD Section 9C

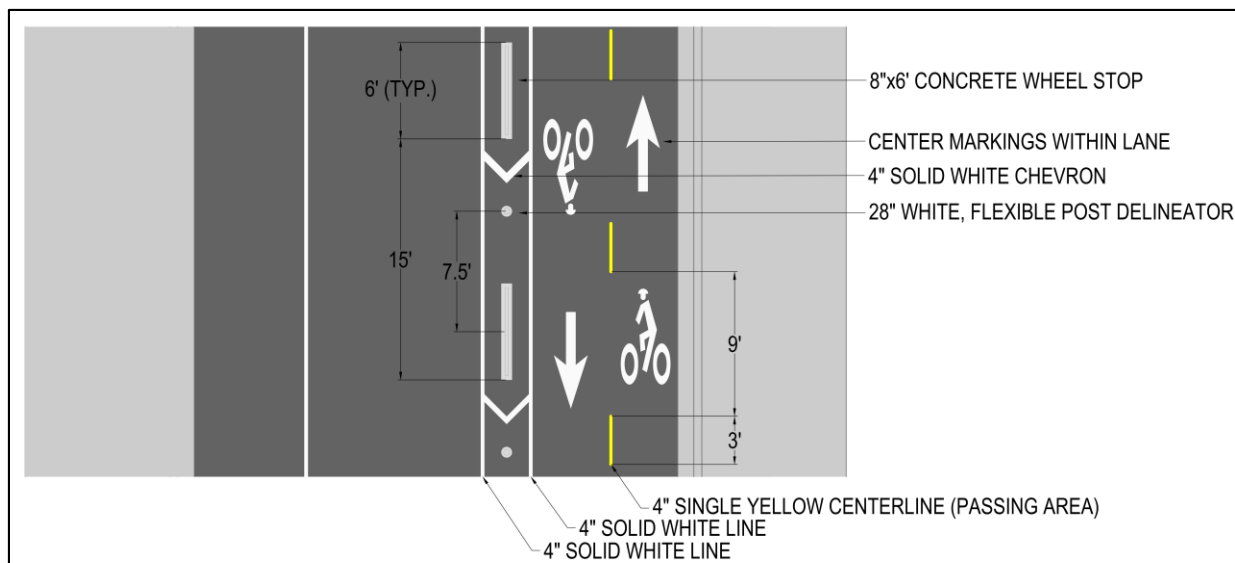

**Figure 20 | Protected Two-Way Bicycle Lane**

### 3.1.4.2 Raised Two-Way Bicycle Lanes

A raised two-way bicycle lane refers to a facility which is located at the same grade (and adjacent to) a sidewalk. Lane lines are not required between the raised two-way protected bicycle lane and pedestrian sidewalk. However, the raised two-way bicycle lane shall be visually distinct and separate from the sidewalk.

The preferred method of separation is to use porous flexible pavement (or similar) for the bicycle lane(s), which requires 6" concrete curb along either side. This configuration provides not only a visual color distinction from concrete sidewalk, but also a 6" longitudinal element distinct from standard 3' concrete sidewalk squares.

When a raised two-way bicycle lane is located adjacent to a parking lane, a 5' buffer should be included between vehicle and bicycle lane(s) to provide clearance from vehicle door swing.

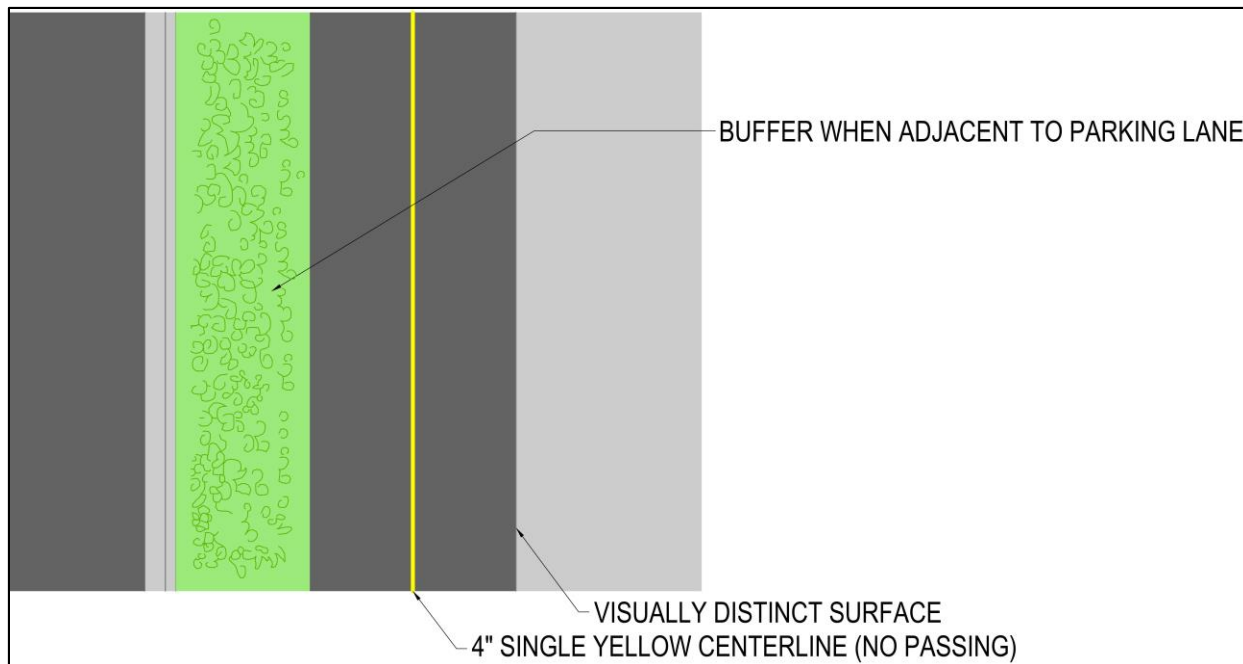
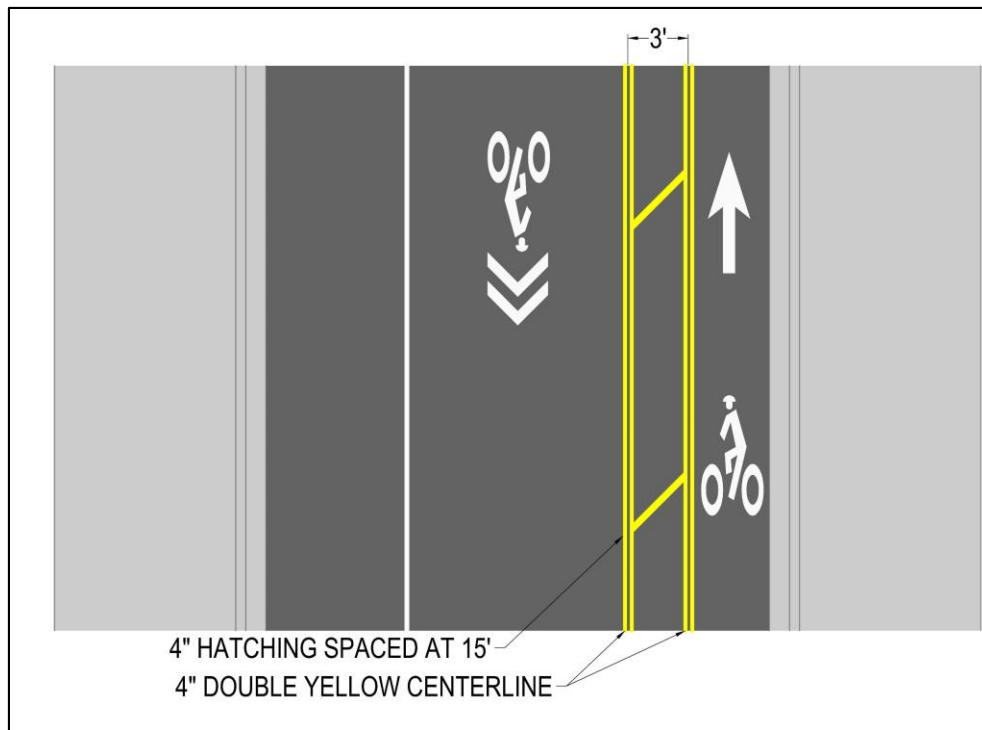

**Figure 21 |** Raised Two-Way Bicycle Lane

### 3.1.5 Contraflow Bicycle Lanes

A buffer should be provided between a contraflow bicycle lane and vehicular travel lane, consistent with *MUTCD* Figure 3D-4. If provided, it shall be a minimum of 18" wide, preferred 3' wide. 4" double yellow centerline markings shall be provided between the contraflow bicycle lanes and vehicular travel lanes.

The lane line between the bicycle lane at the curb shall be a 4" solid white line. A curb-side lane line is not required if a gutter pan is present.



**Figure 22** | Contraflow Bicycle Lanes

An alternative configuration permits the use of a vehicular parking lane between the contraflow bicycle lane and the curb. Parking lanes shall be a minimum of 7' wide and separated from the bicycle lane by a 3' buffer with 4" white lines. In lieu of double yellow centerline markings and a buffer space, a 4" solid yellow lane line shall separate the contraflow bicycle lane from the opposing vehicular traffic.

### 3.1.6 Shared Bicycle/Transit Lanes

See **Chapter 5**. Locations where buses stop in bicycle lanes shall be marked with green thermoplastic pavement markings. Lane markings shall be consistent with those for dedicated bicycle facilities.

Shared bicycle and transit only lanes shall be marked with red pavement paint. Lane markings shall be consistent with those for dedicated transit facilities.

### 3.1.7 Advisory Bicycle Lanes

Advisory Bicycle Lanes are located between curbside parking lanes and a shared, two-way center vehicle lane. Parking lanes shall be a minimum of 7' wide and separated from the bicycle lane by 4" solid white lines. Advisory Bicycle Lanes shall be a minimum of 5' wide and separated from the center vehicular lane by a 6" white line, 2' long with a 4' skip. The center vehicular travel lane should measure between 11'

and 16' for two-way travel. The bicycle facility should revert to shared lane markings within 30 feet of an intersection, including a double yellow centerline between vehicular travel lanes.

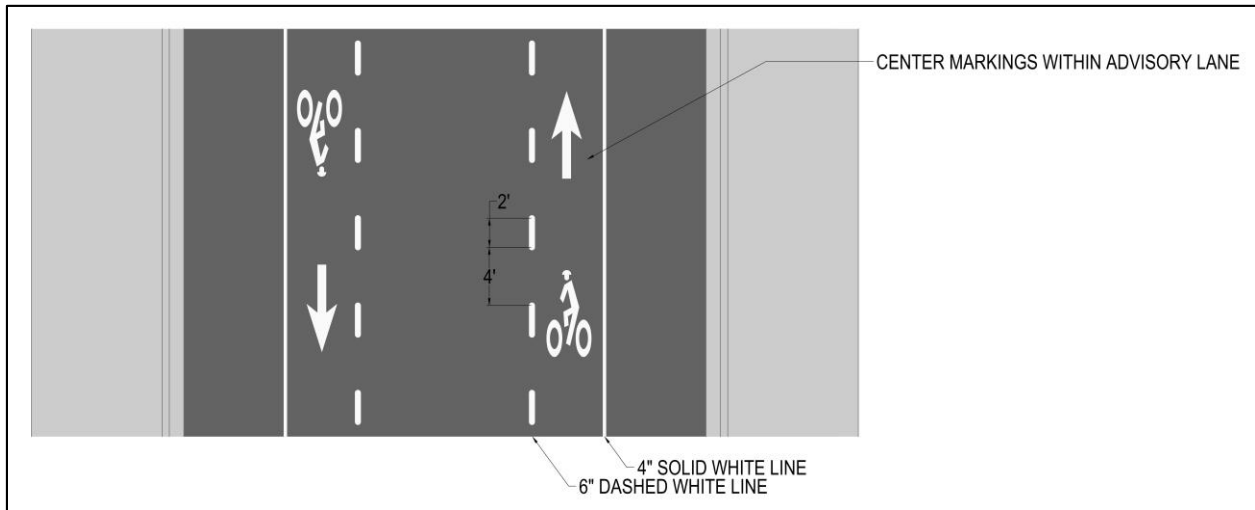

**Figure 23 |** Advisory Bicycle Lanes

### 3.2 Channelizing Devices

Channelizing devices and delineators are used to separate and designate bicycle facilities when adjacent to vehicular traffic. Between intersections, channelizing devices provide protection to protected bicycle lanes from errant vehicles and discourage parking and stopping within bicycle lanes. At intersections, channelizing devices separate bicycles from turning vehicles and visually establish the beginning of dedicated bicycle facilities.

The selection and placement of channelizing devices is based on the classification of the roadway facility as well as availability of right-of-way. See **Table 3** for the preferred device selection matrix.



**Table 3 | Channelizing Device Selection Matrix**

Device Type	Functional Classification	Use Case	Buffer Width	Device spacing	Reflector or Post Use
Flexible Post Delineator	(any)	Roadway Retrofit Quick Build Limited Buffer Space	6" min 3' preferred	10' - 20'	28" flexible posts, usually white and placed in center of buffer zone.
Cast-in-Place/ Granite Curb	Minor/Major Arterial	Road Reconstruction <b>Preferred Treatment when Possible</b>	2' min 4' max	Continuous	28" flexible posts or 1" reflectors adhered on top
Bicycle Lane Rail	Minor/Major Arterial	Roadway Retrofit Limited Buffer Space High need for Protection	6" min 4' max	Continuous	28" flexible posts integrated into interlocking rail system. Reflective tape on rails.
2'x8' Pre-cast Concrete	Minor/Major Arterial	Roadway Retrofit 3'+ Available Buffer	3' min 4' preferred	15' – 20' on center	28" flexible posts or 1" reflectors adhered on top, 28" - 36" flexible post in between
1.5'x8' Pre-cast Concrete	Minor/Major Arterial	Roadway Retrofit 2'-3' Available Buffer	2' min 3' preferred	15' – 20' on center	28" flexible posts or 1" reflectors adhered on top, 28" - 36" flexible post in between
8"x6' Concrete Wheel Stop	Collector or Minor Arterial	Roadway Retrofit Limited Buffer Low Traffic Volume	8" min 3' preferred	10' – 16' on center	28" flexible posts or 1" reflectors adhered on top, 28" - 36" flexible post in between
2' W x 4' L x 2' H Movable Planter	(any)	Shared Pedestrian Activity Zones	3' min 5' preferred	16' – 20' on center	28" - 36" flexible post in between, flush mount base only
7"x6' Rubber Wheel Stop	Local, Collector, or Minor Arterial	Temporary/Interim Installation	7" min 3' preferred	10' – 16' on center	28" - 36" flexible post in between
7" W x 8' L x 6" H Wood Timber	Local or Collector	Aesthetic Treatment for Wooded Area NPS Property	8" min 3' preferred	12' – 20' on center	28" flexible posts or 1" reflectors adhered on top, 28" - 36" flexible post in between
Zicla Zebras	Local or Collector	Dedicated bicycle lane – no parking	6" min 8" preferred	4.5' – 8.5' on center	28" flexible posts in between, or used interchangeably

The preferred configuration for the use of channelizing devices is the use of curbing, either granite or cast-in-place. For interim or rapid deployment applications, the preferred configuration is an alternating flexible post delineator and wheel stop. For one-way bicycle facilities these should be spaced at 15' intervals between chevron markings. For two-way facilities, channelizing devices should be spaced every 7.5' between chevrons. This configuration provides both visual separation and physical protection of the bicycle lane from vehicular traffic and reduces the likelihood of vehicular encroachment into two-way bicycle facilities.

Vertical channelizing device elements shall be provided for one-way and two-way protected bicycle lanes.

Note that flexible post delineators may be used at various positions along a bicycle facility to emphasize its presence and protect bicycle users. Flexible post delineators should be placed at the beginning of a bicycle lane after an intersection or driveway break. They may also be located adjacent to an intersection or driveway to discourage motorists from following turn radius that encroaches on the paths of both bicycle lanes and crosswalks.

### 3.3 Bicycle Facility Symbols

Bicycle lane symbols are used to visually identify proper bicycle lane position as well as the designation of facilities for bicycle use only. They are placed at the beginning of a bicycle lane/block and on approach to an intersection. If a block or segment of roadway that includes a bicycle facility extends more than 300' between intersections, an additional symbol may be used for clarification mid-block.

One "helmeted bicyclist" lane symbol and arrow (*MUTCD* Figure 9C-3.B) shall be placed at the beginning of a bicycle lane, approximately 15'-25' downstream of an intersecting roadway. A second symbol and arrow shall be placed on an approach to an intersection, at least 1' upstream from the stop bar (DDOT

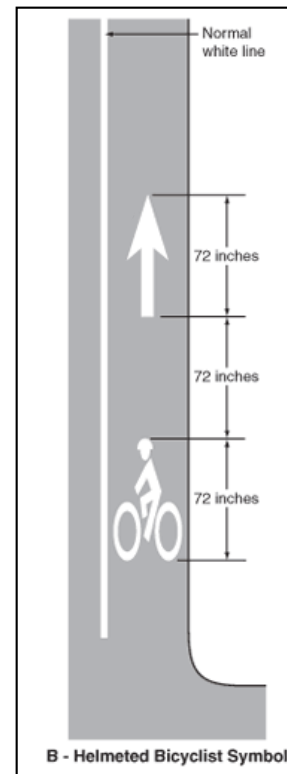

**Figure 24** | Figure 9C-3 (Excerpt) from the *MUTCD*, Element B: Helmeted Bicyclist Symbol

standard drawing 605.06). If a block or segment of roadway that includes a bicycle facility extends more than 300' between intersections or includes more than 2 curb cuts, an additional symbol may be used for clarification mid-block or approximately every 300' (arrow optional).

### 3.3.1 Bicycle Lanes

Dedicated, buffered, and protected bicycle lanes shall be marked with the “helmeted bicyclist” symbol, *MUTCD* Figure 9C-3.B (DDOT Standard Drawing 605.19). The symbol shall be centered within the bicycle lane. In the direction of travel, the bicycle marking shall be 6' long, followed by a 6' gap, followed by a 6' long arrow. The symbol and arrow shall be placed at the beginning of a bicycle lane, approximately 15' - 25' downstream of an intersection. The downstream marking shall be placed 4' downstream of the beginning of a parking lane, if present (outside of the turning vehicle wheel track).

### 3.3.2 Shared Lanes

Shared lane markings should not be placed on roadways that have a speed limit above 25 mph<sup>11</sup>. Vehicular and bicycle shared lanes shall be marked with the “helmeted bicyclist” shared lane symbol, *MUTCD* Figure 9C-9.B (DDOT Standard Drawing 605.19). The symbol shall be centered within the travel lane, at a minimum of 11' from the face of the curb with adjacent parking (4' minimum from face of curb in locations without parking). In the direction of travel, the bicycle marking shall be 6' long, immediately followed by 2- 6" chevrons spaced 6" apart. If a block or segment of roadway that includes a shared bicycle lane extends more than 300' between intersections, an additional symbol may be used for clarification mid-block or approximately every 300'.

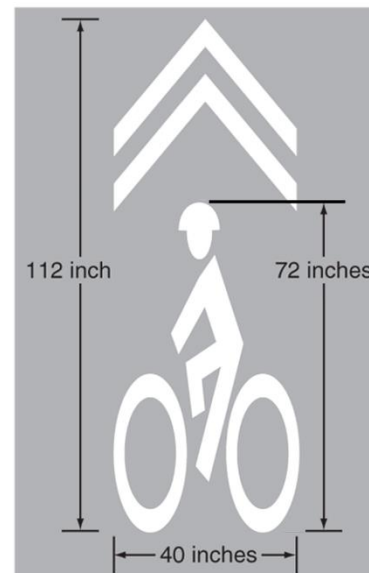

**Figure 25 |** Shared Lane

Additionally, shared lane markings shall not be placed on high-volume roadways depending on lane width and average daily traffic. See **Table 4** for preferred volume thresholds.

<sup>11</sup> *MUTCD*, Section 9C-07.

**Table 4 | Shared Lane Marking Volume Thresholds**

Lane Width	Traffic Volume			
	5,000	10,000	15,000	20,000
10'	Yes	Maybe*	Maybe*	No
11'	Yes	Yes	Yes	Maybe*
12'	Yes	Yes	Yes	Maybe*
13'+	Yes	Yes	Yes	Yes

\*Dependent on other factors and in discussion with the DDOT project manager.

### 3.3.3 Shared Lanes with Transit

Shared bicycle and transit lanes should be marked with red pavement paint and shall include the words “BUS BIKE ONLY” in addition to a shared bicycle lane symbol. One set of word pavement markings shall be placed at the beginning of a shared lane, approximately 15’-25’ downstream of an intersection. The word markings should repeat at approximately 200’ intervals, such that they are repeated twice on each block. The shared bicycle lane marking shall be placed between the set of word pavement markings, such that the set of word markings and shared lane symbol alternate approximately every 75’.

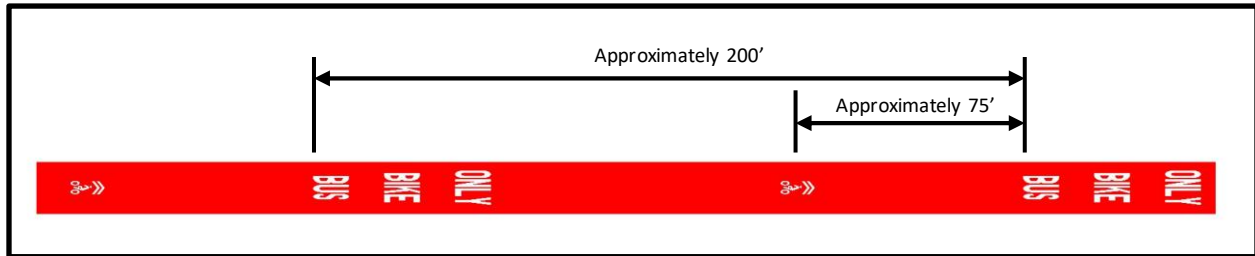

**Figure 26 | Shared Bicycle Transit Lane Marking Spacing**

### 3.3.4 Intersection Bicycle Box

An intersection bicycle box is a designated area on the approach to a signalized intersection, between an advance stop line and the intersection stop line. It is intended to provide bicycles a space in which to wait in front of stopped motor vehicles during the red signal phase so that they are more visible to motorists at the start of the green signal phase. Positioning bicyclists in the center of the appropriate lane allows them to turn from a location where they are more visible to surrounding traffic, can increase the visibility of stopped bicycle traffic at an intersection, can reduce conflicts between bicycles and motor vehicles, can help mitigate intersection right-turn ("right-hook") conflicts, and can help group bicycles together to clear intersections more quickly.



**Figure 27 |** Intersection Bicycle Box on M Street NW

Intersection Bicycle Box design is subject to FHWA *Interim Approval for the Option Use of an Intersection Bicycle Box (IA-18)*. A bicycle box shall be formed by the placement of an advance stop line at least 10 feet in advance of an intersection stop line. Intersection bicycle boxes shall be marked with green pavement paint and include the “helmeted bicyclist” symbol, *MUTCD* Figure 9C-3. Multiple “helmeted bicyclist” symbols may be used for multi-lane roadway approaches (*guidance: 1 per travel lane or parking lane*). The box shall be located at least 4’ in advance of an intersection approach crosswalk and both the upstream and downstream edge of the box shall be marked with a solid white vehicular stop bar.

If a separated right turn lane is not provided for vehicular turning movements, vehicular right turns on red shall be restricted.

### **3.3.5 Two-Stage Turn Queue Box**

The use of a two-stage turn queue box is subject to *MUTCD Interim Approval for Optional Use of Two-Stage Bicycle Turn Boxes (IA-20)*. A two-stage turn queue box is a marked area where bicyclists are



anticipated to make two-stage crossings to execute a left turn. During the first stage, the bicyclist moves from the bicycle lane to the turn queue box generally located within the intersection but outside the path of travel. The bicyclist then positions in the desired direction of travel and moves forward when the traffic control device permits. An ancillary benefit of the two-stage turn queue box is that the bicyclist is visibly positioned in front of the queue of traffic in the desired direction of travel.



**Figure 28 |** Two-stage Turn Queue Box on 4<sup>th</sup> Street SW at Jefferson Drive SW

Note that the two-stage turn queue box should be located in a protected position (outside the path of moving vehicular traffic) but may be located ahead of a travel lane if the conflicting movement is controlled and in the direction of the bicycle turn. This is typically within the space created by parking lanes, or between the crosswalk and the curb line of the intersecting roadway. The two-stage turn queue box shall also be located outside the flow of through bicycle traffic.

Two-stage turn queue boxes shall be marked with green pavement paint and the “helmeted bicyclist” symbol, *MUTCD* Figure 9C-3 in the direction of entering bicycle traffic. It shall include an arrow in the direction of the intended turn. The outside dimensions of the two-stage turn queue box will vary based on the roadway and intersection configuration but should measure a minimum of 48” by 48”. The two-stage turn queue box shall include a 4” solid white line around the perimeter of the box and a 6” solid white line when adjacent to a vehicular travel path.

See **Section 4.4.2** for additional signing requirements for two-stage turn queue boxes.

### **3.3.6 Turn Pocket**

In some cases, intersection configuration or limited right-of-way may inhibit the installation of a two-stage turn queue box. In these cases, it is necessary to introduce a bicycle turn pocket. In this configuration, bicycles shall not make a left turn during the opposing green signal phase and are required to stop and wait for the pedestrian signal phase. During the pedestrian crossing phase, bicyclists may then use the crosswalk to make the left turn but must yield to crossing pedestrians. This configuration enables bicyclists to queue outside of both vehicular and bicycle through traffic.

To accommodate the turn pocket, buffer width may need to be reduced to allow for the additional bike pocket. In this case, the buffer and lane shall taper at a 3:1 ratio.

A turn pocket shall be marked with “USE XWALK FOR TURNS” pavement markings on approach to the intersection. See **Section 4.4.3** for additional signing requirements for bicycle turn pockets.



**Figure 29** | Bicycle Turn Pocket Approach of Pennsylvania Avenue NW at 13 ½ Street NW

### 3.4 Crossings

At intersections, the lateral spacing between the vehicular and bicycle travel lane shall (at a minimum) maintain the same spacing as the upstream vehicle and bicycle lanes. The offset may increase, as in cases where dedicated bicycle lanes transition to protected bicycle lanes. Bicycle lane width shall be constant through an intersection or driveway.

Bicycle lane marking widths shall be consistent with the approach markings. These are typically a 6" white lane line between vehicular traffic and bicycle traffic, and a 4" white lane line between bicycle traffic and parking lane (or theoretical curb line).

Channelizing devices shall permit adequate vehicular turning radius from the travel lane, typically a minimum of 15'. If used, it is preferable for flexible post delineators to indicate the start and end of an intersection or driveway crossing when alternating between post delineators and curb stops.

#### 3.4.1 Intersection Crossing

The preferred treatment of an intersection through-lane marking is 2' skip and 4' space green thermoplastic pavement marking with 6" white lane line between vehicular traffic and bicycle traffic,



and 4" white lane line between bicycle traffic and parking lane (or theoretical curb line). Placement of the skip shall be located in alignment of the crossing vehicular wheel path. Bicycle crossing markings shall not be provided through an intersection unless there is a receiving bicycle lane.<sup>12</sup>

Green thermoplastic bar markings are optional through a local-local intersection, but outside lane striping shall be provided for dedicated, buffered, or protected bicycle lanes. The line between buffers and the vehicular travel lane shall not be marked through intersection crossings.



**Figure 30** | Intersection Crossing along L'Enfant Plaza SW

### 3.4.2 Driveway Crossing

Where dedicated bicycle lanes cross a driveway, alley, or other curb cut, a 2' skip and 4' space 6" white lane line between vehicular traffic and bicycle traffic shall be provided, and 4" white lane line between

<sup>12</sup> NACTO *Urban Bikeway Design Guide*, Page 53

bicycle traffic and parking lane (or theoretical curb line) shall be provided. If the facility is a protected bicycle lane, all lane lines shall be 4". If the bicycle lane is adjacent to a gutter pan, the 4" white lane line shall not be placed. Driveway crossing markings shall begin and end approximately where the driveway curb return meets the roadway curb tangent. If the bicycle facility is a protected bicycle lane or if the driveway serves a larger volume of traffic, green thermoplastic pavement markings shall also be included between the lane lines. If present, a minimum of 3 green spaces shall be used for all driveway applications.

If present, channelizing devices shall be set back from the driveway to accommodate the design vehicle turn radius (such as a passenger vehicle for a parking garage or single unit truck for loading dock). The line between buffers and the vehicular travel lane shall be marked through driveway crossings. See **Figure 31** for a typical configuration at a driveway crossing.

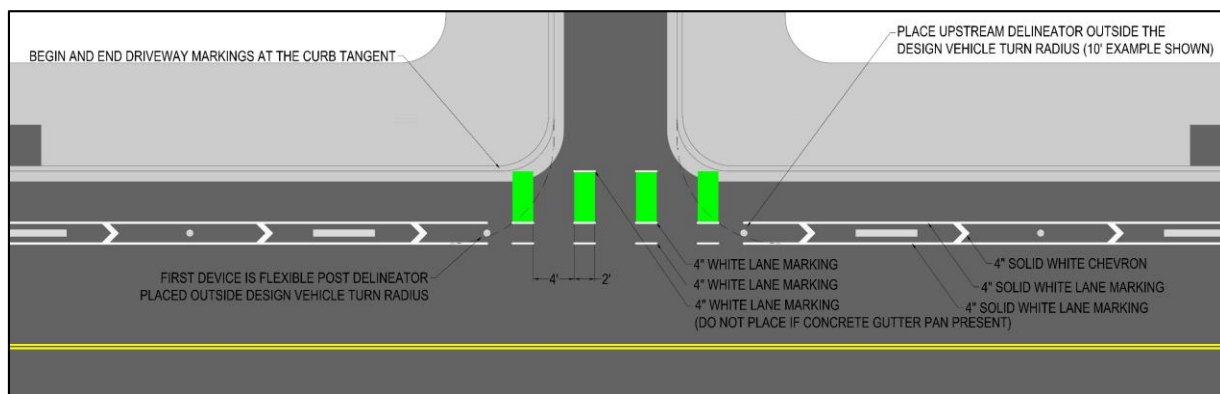
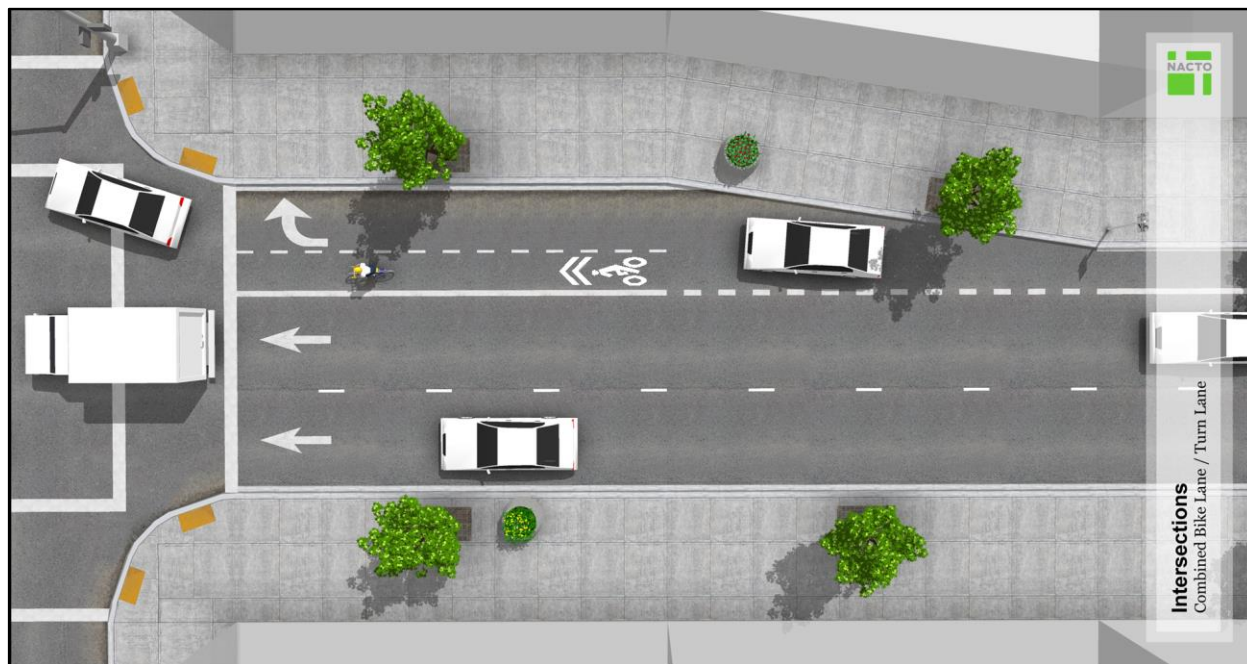

**Figure 31 | Protected Bicycle Lane at Driveway**

### 3.4.3 Bicycle Lanes at Vehicular Turn Lanes

Thresholds for the application of shared or separate vehicular right-turn lanes are provided in **Section 4.1.1.4**. A separate bicycle lane between vehicular through and right-turn lanes shall maintain the approach width of the upstream bicycle lane. A 2' long, 6" wide solid white lane line shall be placed between the vehicular through lane and bicycle through lane and a 'helmeted bicyclist' symbol and arrow shall designate the bicycle lane. If the vehicular turn lane is less than 10' wide, the while lines shall be installed with 2' skip spacing and a 'helmeted bicyclist' shared lane symbol shall be used. Green thermoplastic markings are optional but recommended.

In locations with a shared or mix-flow bicycle and right-turn lane, the theoretical curbside edge of the bicycle lane shall be indicated with a 2' and 2' skip 4" wide white lane line (see **Figure 32**). Note that shared lane markings (or a “sharrow”) shall be used in combined bicycle and right turn lanes.



**Figure 32** | Right-Turn Mixing Zone/Combined Right-Turn Lane

Source: NACTO, edited to include shared lane marking.

### 3.4.4 Pedestrian Crossing

At intersections or other locations where pedestrian and bicycle markings conflict, pedestrian markings take precedence over bicycle lane markings. Green markings or paint shall not be visible within pedestrian crosswalks.

At locations where bicycle and pedestrian traffic are mixed, high visibility crosswalk markings shall be used to designate the crossing.

### 3.5 Bicycle Parking

Bicycle parking shall conform to the standards and guidance outlined in the DDOT DEM, section 29.5 and the District of Columbia Municipal Regulations Title 18, Chapter 21, and Title 11 (ZR16), Chapter C8. Additionally, see the DDOT *Bike Parking Guide*, dated June 2018. Guidance for short-term bicycle parking within public right-of-way is provided below.

### 3.5.1 Bicycle Racks

For short-term bicycle parking within public right-of-way, the preferred configuration is an inverted U-shaped rack design, mounted upon parallel bars or independently. Dimensions and mounting styles may vary between manufacturers (see DDOT standard drawing 605.14). Bicycle racks must:

- Support the bicycle frame in at least 2 places, allowing the frame and wheel to be locked using a U-lock or cable lock.
- Prevent the wheel of the bicycle from tipping over
- Not damage the bicycle
- Be durable and securely anchored
- Allow for front-in or back-in parking

Other allowable designs include the Golden Triangle (post and ring) or Downtown BID (inverted square U) style racks.

Unacceptable designs include wave-style and grid-style multi-bicycle racks as these designs can damage bicycles.

Placement of bicycle racks should be located within the sidewalk furnishing zone, a minimum of 2' from back of curb (3' recommended). Bicycle rack may be located along building fronts; however, 6' of clear pedestrian sidewalk shall be maintained at all times. For areas that experience heavy pedestrian volumes, more pedestrian clear space is recommended. If insufficient space exists within the sidewalk furnishing zone, bicycle racks may be installed within an on-street zone such as an existing parking lane (see **Section 3.5.2**).

Bicycle racks shall be set back a minimum of 5' from crosswalks and fire hydrants. Bicycle racks shall be set back a minimum of 4' from loading zones, bus zones or other bus stop elements. Bicycle racks shall be set back a minimum of 3' from all other street furnishings or obstructions. <sup>13</sup>

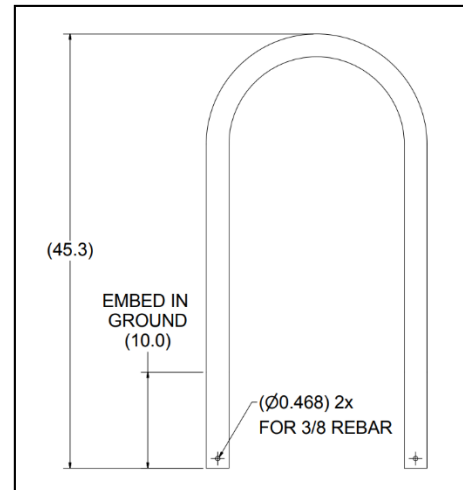

**Figure 33** | Example of U-shape Bicycle Rack

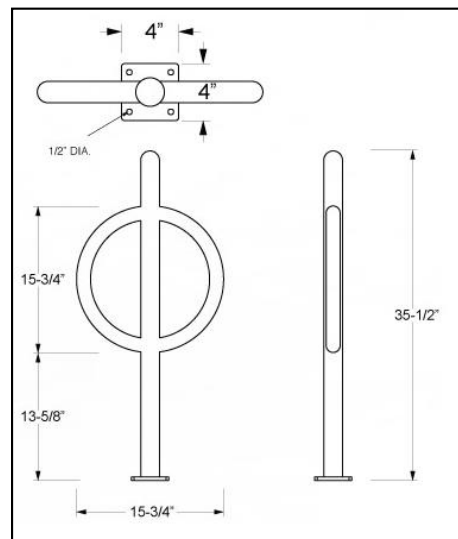

**Figure 34** | Example of Ring-Style Bicycle Rack

<sup>13</sup> DDOT *Bike Parking Guide*

### 3.5.2 Bicycle Corral

Bicycle racks may be mounted within a clear and protected on-street zone, typically within an existing vehicular parking lane or within a protected bicycle lane buffer. On-street bicycle corrals shall permit 2' of unobstructed space around bicycle racks and bicycles without entering an adjacent vehicular right-of-way.<sup>14</sup> In cases of limited right-of-way, bicycle corral racks may be installed at an angle from perpendicular to provide the 2' buffer in all directions.

The perimeter of the unobstructed area shall be marked with 6" solid white line when adjacent to a vehicular travel lane and include white retroreflective posts at 3' spacing. A 4" solid white line shall be used elsewhere. Concrete or rubber curb stops may be added on the leading and trailing end of the bicycle corral (perpendicular to the travel lane) to prevent vehicle encroachment.

### 3.5.3 Capital Bikeshare Station

See the NACTO *Bike Share Station Siting Guide* for best practice in locating Bikeshare stations. If located within an existing roadway, the Bikeshare station should allow access towards an on-street bicycle facility. 3' of unobstructed space shall be provided behind the back tires of a Bikeshare station to permit docking and pull-out.<sup>15</sup> Unlike a bicycle corral, the front edge (side without bicycle access) of a Bikeshare station does not require a 2' buffer when mounted along a wall or adjacent to vehicular travel.

If on-street, the perimeter of the Bikeshare Station area shall be marked with 6" solid white line when adjacent to a vehicular travel lane and include white retroreflective posts at 3' spacing. A 4" solid white line shall be used elsewhere. Concrete or rubber curb stops may be added on the leading and trailing end of the Bikeshare station (perpendicular to the travel lane) to prevent vehicle encroachment.

---

<sup>14</sup> City of Redmond *Bicycle Facilities Design Manual*

<sup>15</sup> NACTO *Bike Share Station Siting Guide*

*This page intentionally left blank.*



## 4 Intersection Treatments

### 4.1 Intersection Treatment Selection

Preferred treatments for the intersection of roadways and bicycle facilities are indicated in **Table 5**. Note that this matrix is a starting point, and individual locations will require a consideration of multiple factors prior to design of a bicycle facility.

#### 4.1.1 Overall Intersection Treatment

##### 4.1.1.1 Through Lanes

Dedicated, buffered, or protected bicycle lanes may have longitudinal crossing pavement markings through the intersection. If provided, these shall continue the width and configuration of the approaching bicycle facility through the intersection. The markings shall be consistent with **Section 3.4.1**. If the bicycle lanes do not continue on the receiving side of an intersection, a crossing shall not be provided. In circumstances where a dedicated facility transitions to a shared facility, a bicycle box may be used to place bicycle and vehicles within the same travel way. Green thermoplastic bar markings are optional through a local-local intersection, but outside lane striping shall be provided for dedicated, buffered, or protected bicycle lanes.

In locations where multiple bicycle facilities intersection, the larger facility (or the facility located along a higher-classification roadway) should have continuous intersection crossing markings. Intersection bicycle facility crossing markings may break to enable another to be marked continuously. In cases of similarly-sized facilities, additional bicycle markings and separation may be required to accommodate bicycle left-turn lanes/two-stage turn queue boxes or other bicycle queuing areas.

At signalized intersection where dedicated, buffered, or protected bicycle lanes conflict with a vehicular right-turn movement, MUTCD W10-15(mod) shall be used (Turning Vehicles Stop for Pedestrians and Bicyclists).

On facilities with shared lanes, intersection crossing treatments shall not be used. Additional bicycle warning signage (MUTCD W11-1) may be used on the minor approaches to alert drivers to the potential presence of bicycles.

**Table 5 | Intersection Treatment Decision Matrix**

Major Road	Major Bicycle Facility	Minor Road	Minor Bicycle Facility	Treatment Scheme Options
Arterial	Protected or buffered	Arterial	Protected	Dedicated Bicycle Phase <sup>1</sup> Major and Minor Intersection Crossing Markings Turn Box <sup>2</sup> Two-Stage Turn Queue Box <sup>1</sup>
		Collector	Protected, buffered, or dedicated	Major and Minor Intersection Crossing Markings Turn Box <sup>2</sup> Two-Stage Turn Queue Box <sup>1</sup>
		Local	Buffered or dedicated	Major Intersection Crossing Markings Minor Street Turn Box <sup>2</sup> Major Street Two-Stage Turn Queue Box <sup>1</sup>
			Shared	Major Intersection Crossing Markings Major Street Two-Stage Turn Queue Box <sup>1</sup>
	None	Any	Protected, buffered, or dedicated	Minor Intersection Crossing Markings Major Street Bicycle Warning Signs
			Shared	Major Street Bicycle Warning Signs
	Collector	Protected, buffered, or dedicated	Collector or Local	Protected, buffered, or dedicated
Shared or none				Major Intersection Crossing Markings Minor Street Bicycle Warning Signs
Shared		Collector or Local	Protected, buffered, or dedicated	Minor Intersection Crossing Markings
			Shared or none	None
Local	Protected, buffered, or dedicated	Local	Dedicated	Signalized: Major Street Turn Box Unsignalized: Signage
		Local	Shared or none	Signalized: Turn Box Unsignalized: Signage
	Shared	Local	Shared or none	None
Collector/Local	Contraflow	Collector/Local	Protected, buffered, or dedicated	Bicycles follow Pedestrian Signal <sup>1</sup> Two-way Bicycle Traffic Warning Assembly
Collector/Local	Contraflow	Collector/Local	Shared or none	Two-way Bicycle Traffic Warning Assembly

<sup>1</sup>Only if Signalized and depending on intersection capacity analysis

<sup>2</sup>Only where intersection control has protected leading left turn phase



#### 4.1.1.2 Contraflow Bicycle Lanes

Contraflow bicycle lane approaches shall be signed consistent with vehicular approaches to multi-way stop-controlled intersections.

Side street approaches to contraflow bicycle facilities shall include additional warning signage (MUTCD W11-1 and W16-5(mod) signs) to indicate the presence of the contraflow bicycle lanes.

#### 4.1.1.3 Bicycle Turning Movements

Where multiple dedicated bicycle facilities intersect at signalized intersections, accommodations should be provided for bicycles to safely cross vehicular flows to adjoining bicycle facilities. At these intersections, bicycle boxes shall be provided at signalized intersections where a leading left-turn phase is provided to vehicles. The bicycle box shall be 10' to 16' long and painted with green pavement coloring.<sup>16</sup> The box shall terminate at least 4' from the pedestrian crosswalk, if present. If a bicycle box is provided at an intersection without separate vehicular right turn lanes, the vehicular right turns on red shall be restricted.<sup>17</sup>

For signalized intersections without a leading left turn phase, a two-stage bicycle left turn queue box may be provided. It shall be located outside of both the bicycle and vehicle travel lanes (in the initial direction of travel), typically within the width of an up- or downstream parking lane. The length of the two-stage bicycle left turn queue box shall be the width of the intersecting parking lane or travel lane, whichever is more appropriate for alignment with the receiving bicycle facility. It shall be marked with a "helmeted bicyclist" symbol in the original direction of travel, with a left-turn arrow pointing in the desired turn direction. Symbols may be scaled to fit within the box.

Two-stage bicycle left-turn boxes may be combined when located adjacent to one another to create a larger waiting area. The size and position of these waiting areas should have sufficient width to allow through bicycles to pass turning bicycles and be located outside of conflicting vehicular travel lanes. Note that vehicular turns on red shall be restricted if the turning movement travels through the bicycle queuing area. See **Figure 38** for typical configuration of bicycle turning movements.

For the signalized intersection of a dedicated bicycle facility with a shared facility, bicycle boxes may be provided on the dedicated facility approaches.

---

<sup>16</sup> NACTO *Urban Bikeway Design Guide*

<sup>17</sup> FHWA *Interim Approval for Optional Use of an Intersection Bicycle Box (IA-18)*

Additional intersection treatments are not required at two-way stop or all-way stop controlled intersections. Additional warning signage may be used based on limitations of sight distance and vehicular volume.

A protected intersection may be used in lieu of either a bicycle box or two-stage turn queue box.

#### **4.1.1.4 Protected Intersection**

Protected intersections, also known as setback or offset intersections, keeps bicycles physically separate from motor vehicles up until the intersection, providing a high degree of comfort and safety for people of all ages and abilities. This design can reduce the likelihood of highspeed vehicle turns, improve sightlines, and dramatically reduce the distance and time during which people on bikes are exposed to conflicts.<sup>18</sup> Protected intersections also help to facilitate the intersection of multiple bicycle lanes. Protected intersections should be created using curb or may installed using flexible post delineators for interim or rapid-deployment applications.

A protected intersection shall reduce the vehicular turn radius and clearly indicate both pedestrian and bicycle crossing paths using intersection crossing markings. The intersection crossing of the bicycle lane shall be set back from vehicular traffic (if cross-section width allows) and marked adjacent to the pedestrian crossing to create the appearance of a single, continuous conflict zone. The bicycle lane approach to the intersection should shift laterally to offset bicyclists traveling through the intersection for the purposes of pedestrian crossing safety.

When installed with curb, an accessible pedestrian refuge should be installed between the vehicular travel lane and bicycle lane. A corner ‘safety island’ should be installed in each corner of the intersection to further protect the bicycle lane(s) from vehicular encroachment. Pedestrian crossings of the bicycle lane(s) shall be marked similar to high-visibility crosswalks, with two 4”, parallel solid white lines running perpendicular to bicycle flow, spaced at least 5’ apart. 1’ wide and 1’ skip solid white lines should be placed between these lines, running parallel to the direction of flow.

Bicycle lanes shall be indicated with green pavement at the corner of the protected intersection to discourage pedestrians from standing in or using the bicycle lanes. A ‘helmeted bicyclist’ pavement marking and arrow should be applied immediately ahead of the bicycle lane crossing to indicate the direction of travel (if space allows).

---

<sup>18</sup> NACTO *Don’t Give Up at the Intersection*

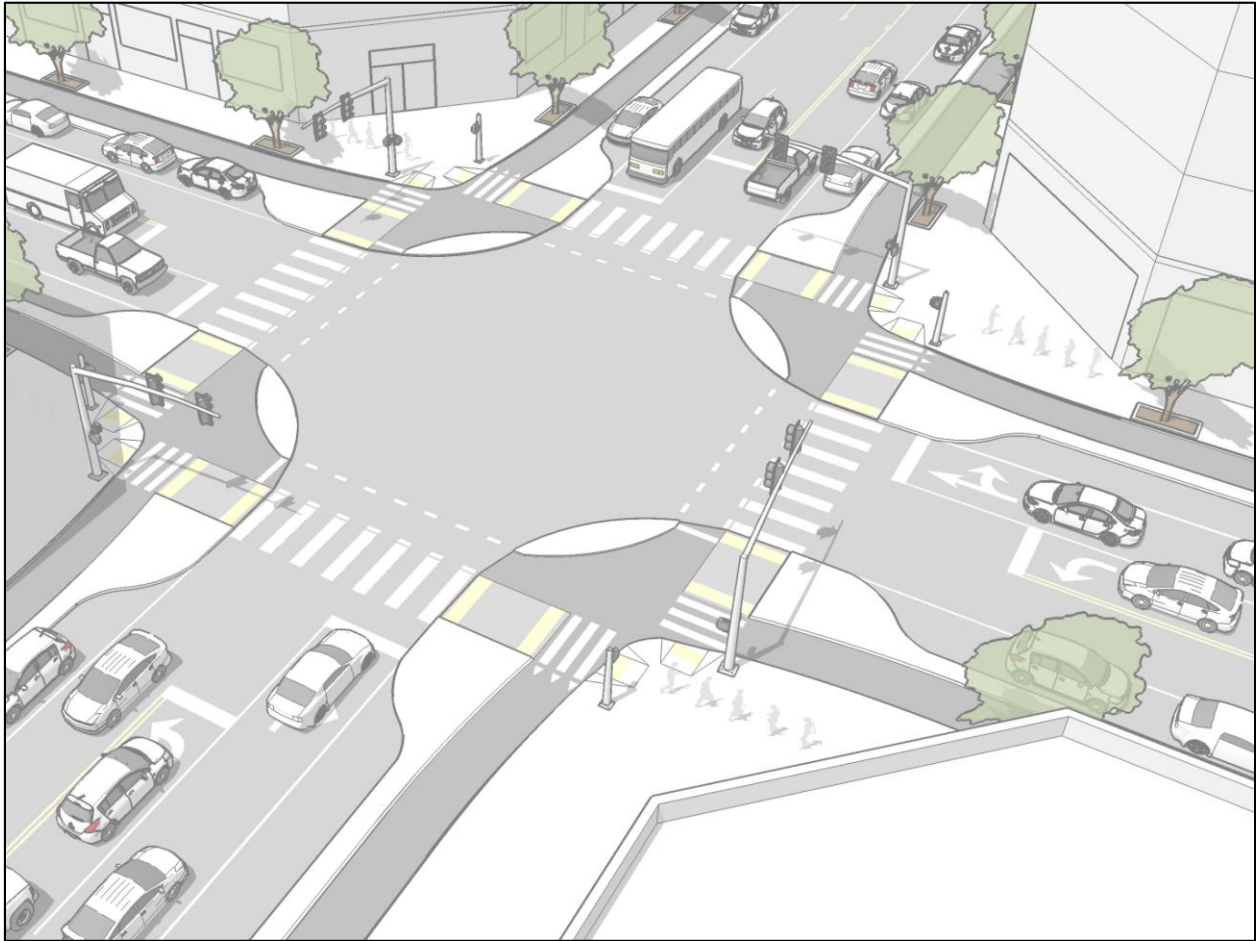

**Figure 35** | Protected Intersection

Source: NACTO

#### 4.1.2 Treatments for Vehicular Turn Lanes

In locations where vehicular right turns and bicycle lanes conflict, treatment varies with vehicular volume. When peak hour vehicular right-turn volumes are:

- less than 50 vph, provide right turn signage R10-15(mod) for motorists
- between 50 vph and 150 vph, use a right turn lane mixing zone, also known as a combined right turn lane (see **Figure 32**)
- more than 150 vph, install a dedicated right-turn lane and designated bicycle through lane (see **Figure 36**)

Right turn “lane drops” shall never be used to cross over a bicycle facility. Alternatively, separate the movements with signalization or create mixed flow ahead of the intersection, then return to protected lanes at the intersection (with the bicycle lane between vehicular through and right-turn lanes).<sup>19</sup>

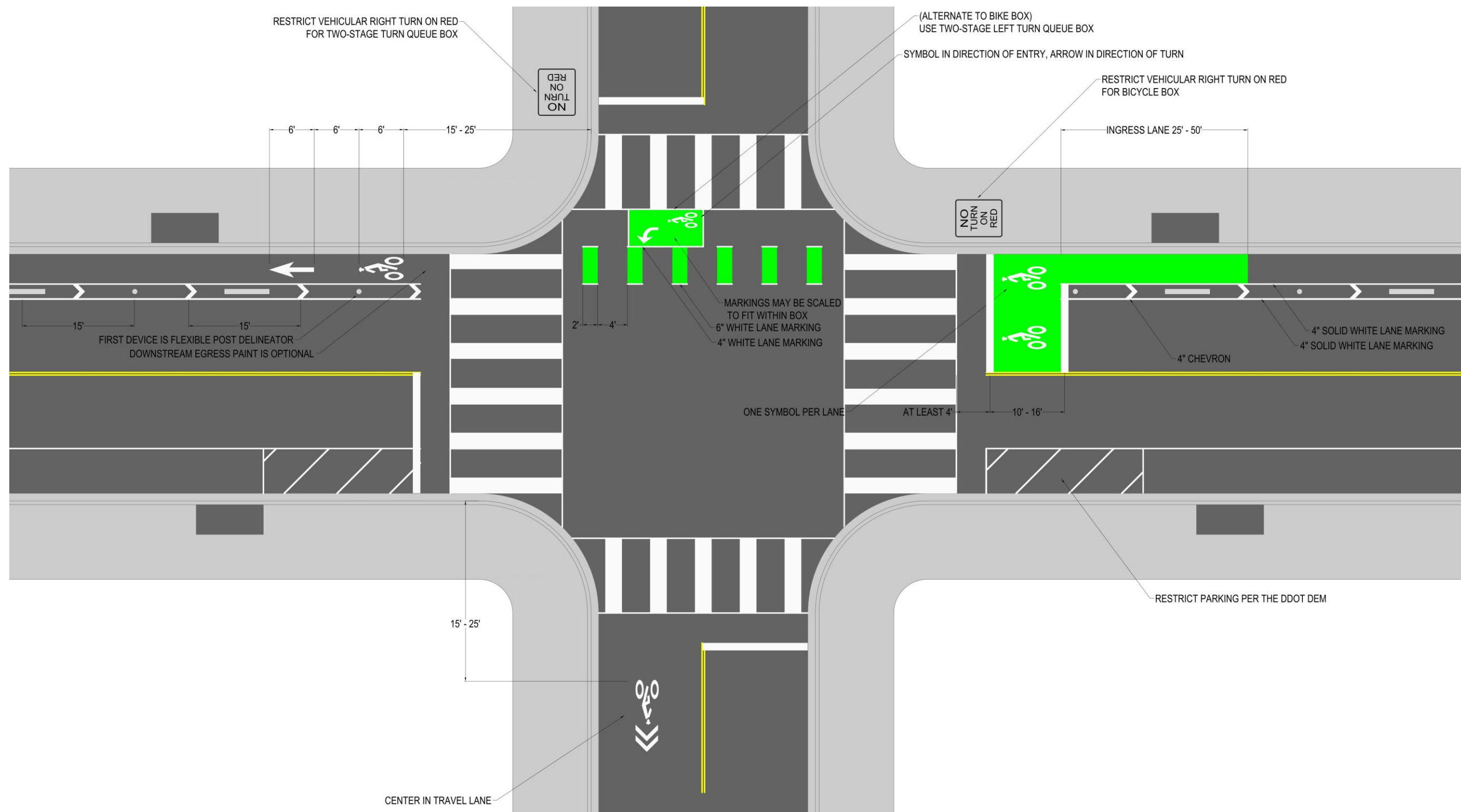

**Figure 36** | Dedicated Right Turn Lane and Bicycle Through Lane on M Street NW

## 4.2 Intersection Typical Layout

The follow section provides examples of facility intersections, combining intersection treatments with geometric configurations. Note that the figures are non-exhaustive, but provide examples of preferred configurations at several typical conditions.

<sup>19</sup> NACTO *Urban Bikeway Design Guide*



**Figure 37** | Protected Bicycle Lane on Collector at Shared Local Street



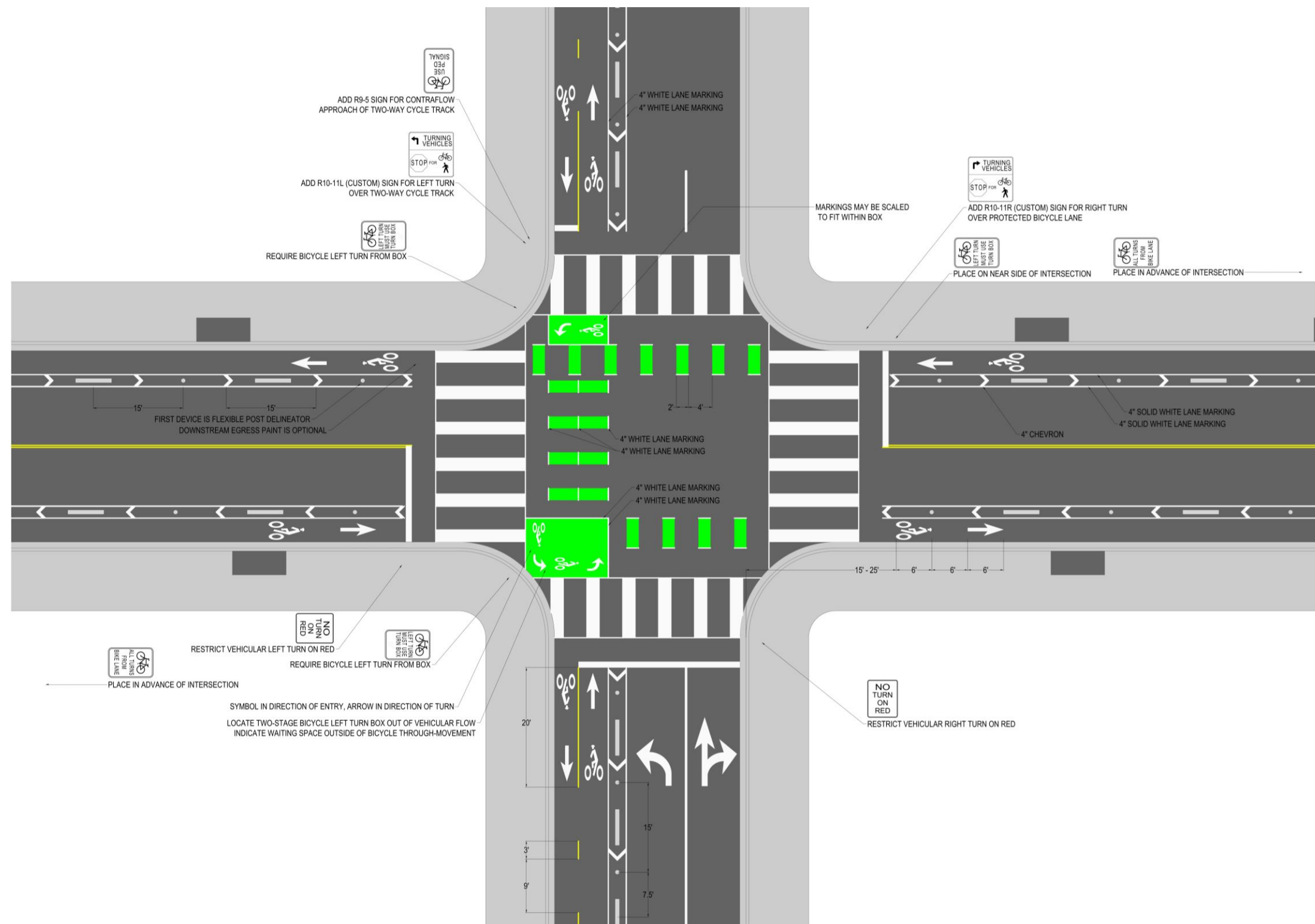

**Figure 38** | Protected Bicycle Lanes on Collector at One-Way Arterial with Two-Way Protected Bicycle Lanes

## 4.3 Traffic Signal Operations

### 4.3.1 Intersection Phasing Selection

Bicycle facilities should operate concurrently with the adjacent vehicular facility. If a contraflow bicycle lane is provided on a one-way vehicular facility, it should be signed to follow the concurrent pedestrian phase. Note that this pedestrian phase should be operated in recall mode to serve the pedestrian crosswalk and bicycle lane approach during every signal cycle. Alternatively, a dedicated bicycle signal head may be installed subject to the conditions outlined in FHWA *Interim Approval for Optional Use of a Bicycle Signal Face (IA-16)*. If pedestrian recall mode is not warranted as described above and the minor street approaches are actuated, a bicycle recall phase should be added to signal operations with a duration consistent with that described in **Section 4.3.2**.

#### 4.3.1.1 Two-way Bicycle Facilities

Signalized intersections with two-way dedicated bicycle facilities shall separate vehicular turning and bicycle through movements (using the pedestrian signal or a dedicated bicycle signal head). Turns which cross over the two-way bicycle facility at an intersection with this configuration should be protected only and restricted on red, with the exception of the thresholds indicated in **Table 6**.<sup>20</sup> Consider removing or displacing lower-volume left-turning movements (*guidance: less than 50 vehicles on peak hour*) to simplify intersection phasing and reduce delay. If two-stage bicycle queue boxes are used, signs shall be placed to require the use of the boxes.

#### 4.3.1.2 One-way Bicycle Facilities

For one-way protected bicycle facilities, when a clear line of sight is provided (subject to the sight distance calculation in **Section 2.2.1**), permissive turn operations may be allowed based on the thresholds indicated in **Table 6**.<sup>20</sup> Otherwise turning movements should operate as protected only (or be restricted).

**Table 6 |** Permissive Turn Thresholds

Bicycle Facility Operation	Motor Vehicle Facility Operation			
	Two-way Street			One-way Street
	Right Turn	Left Across One Lane	Left Across Two Lanes	Right or Left Turn <sup>1</sup>
One-way	150	100	50	150
Two-way	100	50	0	100

<sup>1</sup>Against contraflow Bicycle Lane

<sup>20</sup> MassDOT *Separated Bike Lane Planning & Design Guide*, Exhibit 6A (partial)

### 4.3.1.3 Shared Bicycle Facilities

Bicycle operations along shared facilities shall adhere to vehicular control devices.

### 4.3.2 Bicycle Minimum Time

Traffic signal interval lengths should be calculated using the formulas found the AASHTO *Guide for the Development of Bicycle Facilities*, Table 4-2 (standing bicycle crossing time), 4-3 (bicycle minimum green time), and 4-4 (rolling bicycle crossing time). See **Equation 2** through **Equation 4**. A design speed of 14.7 feet per second (10 mph) should be used for these calculations in the absence of local data.<sup>21</sup> For locations more likely to experience youth users (such as in the vicinity of schools), existing intersection minimum green and clearance intervals should be verified adequate using a reduced speed and acceleration parameter.

#### Equation 2 | Standing Bicycle Crossing Time

Table 4-2. Standing Bicycle Crossing Time

U.S. Customary		
$BCT_{standing} = PRT + \frac{V}{2\alpha} + \frac{(W+L)}{V}$		
where:		
$BCT_{standing}$	=	bicycle crossing time (s)
$W$	=	intersection width (ft)
$L$	=	typical bicycle length = 6 ft (see Chapter 3 for other design users)
$V$	=	attained bicycle crossing speed (ft/s)
$PRT$	=	perception reaction time = 1s
$\alpha$	=	bicycle acceleration (1.5 ft/s <sup>2</sup> )

Source: AASHTO *Guide for the Development of Bicycle Facilities* Table 4-2

#### Equation 3 | Bicycle Minimum Green Time Using Standing Bicycle Crossing Time

<sup>21</sup> AASHTO *Guide for the Development of Bicycle Facilities*



Table 4-3. Bicycle Minimum Green Time Using Standing Bicycle Crossing Time

U.S. Customary		
$BMG = BCT_{standing} - Y - R_{clear}$ $BMG = PRT + \frac{V}{2\alpha} + \frac{W+L}{V} - Y - R_{clear}$		
where:		
$BMG$	=	bicycle minimum green time (s)
$BCT_{standing}$	=	bicycle crossing time (s)
$Y$	=	yellow change interval (s)
$R_{clear}$	=	all-red (s)
$W$	=	intersection width (ft)
$L$	=	typical bicycle length = 6 ft (see Chapter 3 for other design users)
$V$	=	bicycle speed crossing an intersection (ft/s)
$PRT$	=	perception reaction time = 1 s
$\alpha$	=	bicycle acceleration (1.5 ft/s <sup>2</sup> )

Source: AASHTO Guide for the Development of Bicycle Facilities Table 4-3

**Equation 4 |** Rolling Bicycle Crossing Time Considering Braking Distance

**Table 4-4. Rolling Bicycle Crossing Time Considering Braking Distance**

U.S. Customary		
$BCT_{rolling} = \frac{BD + W + L}{V}$ $BD = PRT \times V + \frac{V^2}{2\alpha}$		
where:		
$BCT_{rolling}$	=	bicycle crossing time (s)
$W$	=	intersection width (ft)
$L$	=	typical bicycle length = 6 ft (see Chapter 3 for other design users)
$V$	=	bicycle speed crossing an intersection (ft/s)
$BD$	=	breaking distance (ft)
$PRT$	=	perception reaction time = 1s
$\alpha$	=	deceleration rate for wet pavement = 5 ft/s <sup>2</sup>

Source: AASHTO *Guide for the Development of Bicycle Facilities Table 4-4*

**4.3.3 Bicycle Signal Head**

Vehicular conflicts at intersection pose potential safety concerns for bicycle facilities. A dedicated bicycle phase may be used to prevent conflicts above a certain volume threshold. For signalized intersections, use the equation  $W = B \times V$ ; where:

- $W$  = volume warrant
- $B$  = the number of bicycles entering the intersection
- $V$  = the number of vehicles entering the intersection

Volumes for  $B$  and  $V$  shall be from the same peak hour. When  $B > 50$  and  $W > 50,000$ , use a dedicated bicycle signal phase (either dedicated bicycle signal head or bicycles follow pedestrian signal head).<sup>22</sup>

<sup>22</sup> FHWA *Separated Bicycle Design Guide*

Intersections with two-way dedicated bicycle facilities shall always separate vehicular turning and bicycle through movements using signalization.

A bicycle signal head may be used at signalized intersections along a contraflow bicycle lane.

A bicycle signal head shall be placed in a location that is clearly visible to approaching cyclists. It shall not be placed in a manner that could visually conflict with vehicular signals. If a bicycle signal head is used on the same approach as a vehicular signal head, it shall be separated vertically or horizontally from the nearest motor vehicle traffic signal face for the same approach by at least 3'.<sup>23</sup>

A supplemental “Bicycle Signal” (MUTCD R10-10b) may be used for bicycle signal heads for enhanced understanding. If used, it should be mounted below the bicycle signal head (preferred) or may be mounted to the side of the bicycle signal head.

#### 4.3.4 Vehicular Right Turn on Red

Vehicular right turn on red operations shall be prohibited for any signalized movements that are required to cross a dedicated bicycle facility.

### 4.4 Intersection Signage

#### 4.4.1 General Signage

Permissive vehicular turning movements that cross over a two-way bicycle facility shall have an R10-15 (mod) “TURNING VEHICLES STOP FOR PEDESTRIANS AND BICYCLES” sign (see **Figure 39**). It may be used in other locations where vehicular turns conflict with bicycle movements if additional signage is needed for increased notice and visibility.



**Figure 39** | R10-15R (mod)  
Stop for Ped-Bike Sign

If any type of bicycle facility begins or terminates at an intersection, appropriate signs may be placed to indicate the start and stop of bicycle lanes (MUTCD R3-17 sign and R3-17aP or R3-17aP plaques).

<sup>23</sup> FHWA *Interim Approval for Optional Use of a Bicycle Signal Face (IA-16)*

If a raised protected bicycle facility is adjacent to a pedestrian sidewalk, signage (MUTCD R9-7) may be provided to indicate the proper positioning of pedestrians and bicycles on the far side of an intersection crossing.

#### 4.4.2 Two-Stage Turn Queue Box Signage

For locations which require the use of two-stage bicycle turn boxes to complete movements, FHWA Interim Approval 20 requires the use of regulatory signing. The signs used shall be the “Two-Stage Bicycle Turn Box Advance (R9-23)” regulatory sign and the “Two-Stage Bicycle Turn Box” (R9-23a, R9-23b) regulatory sign.<sup>24</sup>

Additionally, vehicular right turns on red shall be restricted at locations which would require vehicular movements to conflict with the two-stage bicycle turn box.

#### 4.4.3 Turn Pocket Signage

Bicycle turn pockets shall be accompanied by signage directing bicyclists to use the crosswalk if turns conflict with vehicular movements. Signs which may be used include “Turning Bicycles Use X-Walks” and “Bicycles Use Ped Signal (R9-5)” regulatory signs. As shown in **Figure 40**.

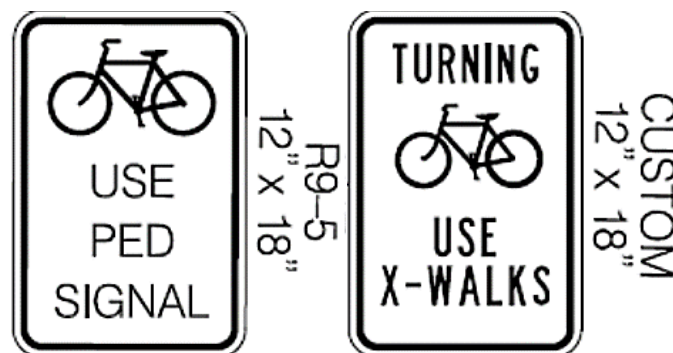

**Figure 40** | Bicycle Turn Pocket Signs

#### 4.4.4 Contraflow and Two-way Bicycle Traffic

Contraflow bicycle lane approaches to unsignalized intersections shall be signed consistent with a vehicular approach to the same intersection. If all approaches to the intersection are stop-controlled, an MUTCD R1-3p “ALL WAY” plaque shall be included. If the intersection street is uncontrolled, the

<sup>24</sup> FHWA *Interim Approval for Optional Use of Two-Stage Bicycle Turn Boxes (IA-20)*

contraflow bicycle lane shall also include “CROSS TRAFFIC DOES NOT STOP” sign (MUTCD W4-4P). Trail-sized signage shall be used to distinguish signs for the bicycle facility.

A contraflow bicycle lane approach to a signalized intersection shall have a posted “BICYCLE USE PED SIGNAL” (MUTCD R9-5) or be provided a dedicated bicycle signal head. If the contraflow bicycle lane is to follow a dedicated bicycle signal head, it shall be signed with a symbolic MUTCD R10-10b “BIKE SIGNAL” sign.

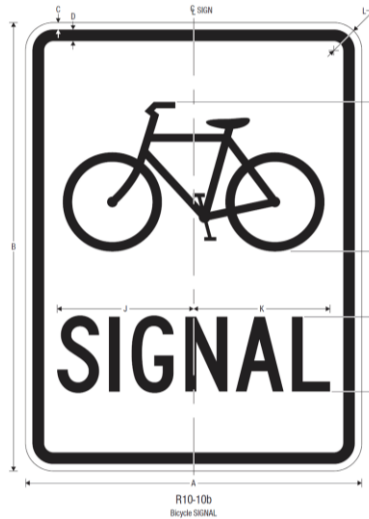
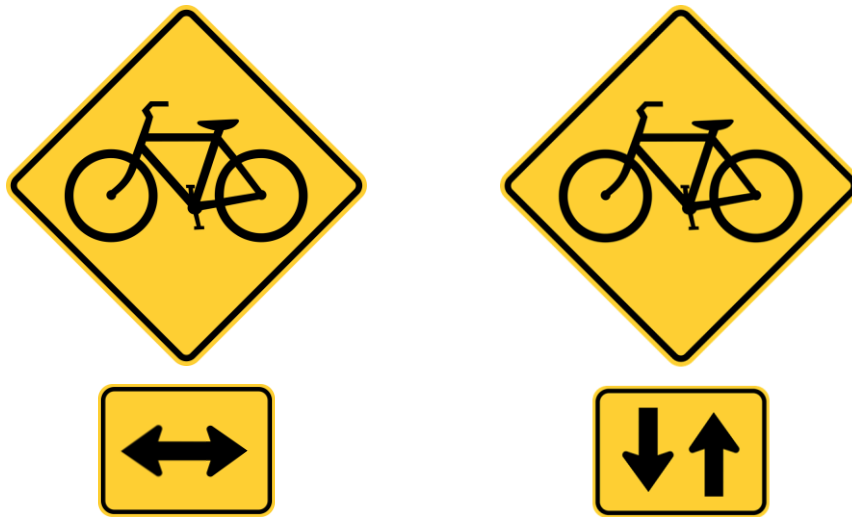

**Figure 41 |** MUTCD R10-10b Regulatory Sign

*Source: MUTCD Interim Approval for Optional Use of an Intersection Bicycle Box (IA-18)*



Unsignalized intersection approaches to streets with contraflow bicycle lanes or two-way protected bicycle lanes shall have bicycle warning signs. For approaches to one-way roadways which include a contraflow bicycle lane, install a W11-1 bicycle warning sign and MUTCD W16-5(mod) arrow in the direction of the contraflow bicycle lane as shown in Figure 42. Use the assembly on the left for cross-street traffic, and the assembly on the right for opposing and parallel traffic.



**Figure 42 |** Contraflow Bicycle Lane Warning Assemblies: W11-1 and W16-5(mod)

## 5 Bicycle Facilities and Transit

### 5.1 Transit Stops

Transit stops should be positioned at the far side of intersections when adjacent to a buffered or protected bicycle facility. All transit stops shall be designed to current DDOT DEM specifications.

#### 5.1.1 Dedicated Bicycle Lane Transit Stop

When dedicated bicycle lanes run adjacent to a parking and bus lane transit stop, the outside-most bicycle lane line shall be a dashed 2' long, 4" solid white line spaced 2' apart. The outside-most lane line shall run along the edge of the concrete bus pad, if present. The inside lane (between bicycle and vehicular traffic) shall be a dashed 2' long, 6" solid white line spaced 2' apart.

When adjacent to a transit stop, the bicycle lane may be narrowed to 4' in order to accommodate the full width of the concrete bus pad.<sup>25</sup>

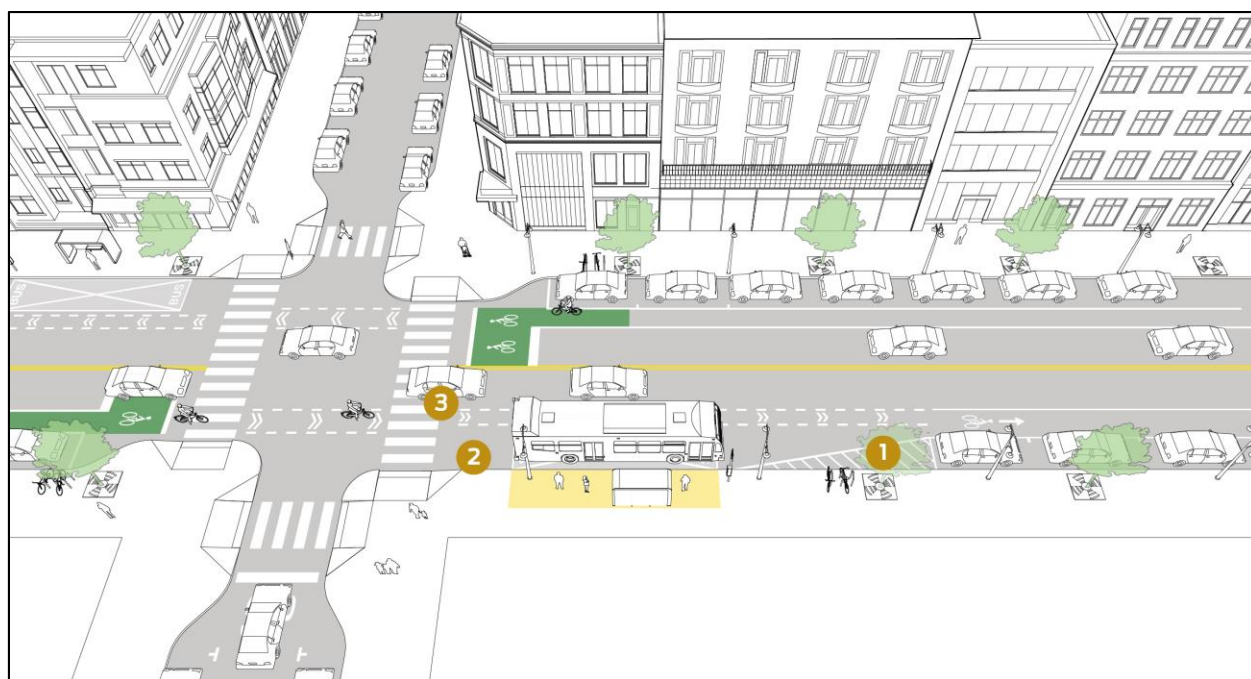

**Figure 43 |** Curbside Transit Stop with Dedicated Bicycle Lane

Source: NACTO

<sup>25</sup> NACTO *Transit Street Design Guide*

### 5.1.2 Shared Bicycle Lane Transit Stop

In cases of severely constrained right-of-way or other limiting factors, it may be required that a bus stop is co-located with protected bicycle lanes. This configuration allows buses to stop within the bicycle lane while dwelling at a bus stop but does not permit any other vehicles to travel within the lane. This configuration should only be installed at far-side bus stops, and in locations where a bus boarding island or shared, raised protected bicycle lanes stop are infeasible.

The protected bicycle lane shall be marked as a 2' skip and 4' space green thermoplastic pavement marking with 4" white lane line between bus traffic and bicycle traffic shall be provided. A 2' and 4' skip 6" white lane line shall be provided along the theoretical vehicular lane line, separating the bus stop from vehicular through traffic. This configuration shall extend throughout the length of the bus stop.

The combined width of the Shared Bicycle Lane Transit Stop should be 13' in width from face of curb to the vehicular lane line to allow bicycles to pass a stopped bus if required.

An example of the preferred configuration is shown in **Figure 47**.

### 5.1.3 Protected-Shared Transit Stop

When a two-way protected bicycle facility runs adjacent to a bus transit stop, the bicycle and bus modes shall be separated. Two options to designate space are 1) provide a protected bicycle lane with designated pedestrian crossing to a bus boarding median island or 2) create a raised, shared pedestrian-bicycle bus zone. When adequate right-of-way exists, the preferred treatment is to establish a separate bus boarding island between vehicular and bicycle traffic.

#### 5.1.3.1 Bus Boarding Island

A bus boarding island may be constructed within an existing parking lane to accommodate bus boarding without obstructing a one- or two-way protected bicycle facility. It shall be constructed to ADA standards for accessible boarding, including providing a clear 8' by 5' area adjacent to the bus stop flag for accessible boarding. Alternatively, the protected bicycle lane(s) may be raised to the level of the bus boarding island and adjacent sidewalk.



**Figure 44** | Bus Boarding Island on 14<sup>th</sup> Street NW

The bus stop island shall be the length of the bus zone and should provide one ADA-accessible crossing of the protected bicycle lane(s) at each end of the island (minimum one, adjacent to upstream intersection crosswalk). Pedestrian crossings of the protected bicycle lane(s) shall be marked similar to high-visibility crosswalks, with two 4", parallel solid white lines running perpendicular to bicycle flow, spaced at least 5' apart. 1' wide and 1' skip solid white lines shall be placed between these lines, running parallel to the direction of flow. An example for the layout of a Bus Boarding Island is shown in **Figure 45**. An example of a Bus Boarding Island with raised two-way protected bicycle lane is shown in **Figure 46** (note that near-side transit stops are not a preferred configurations).

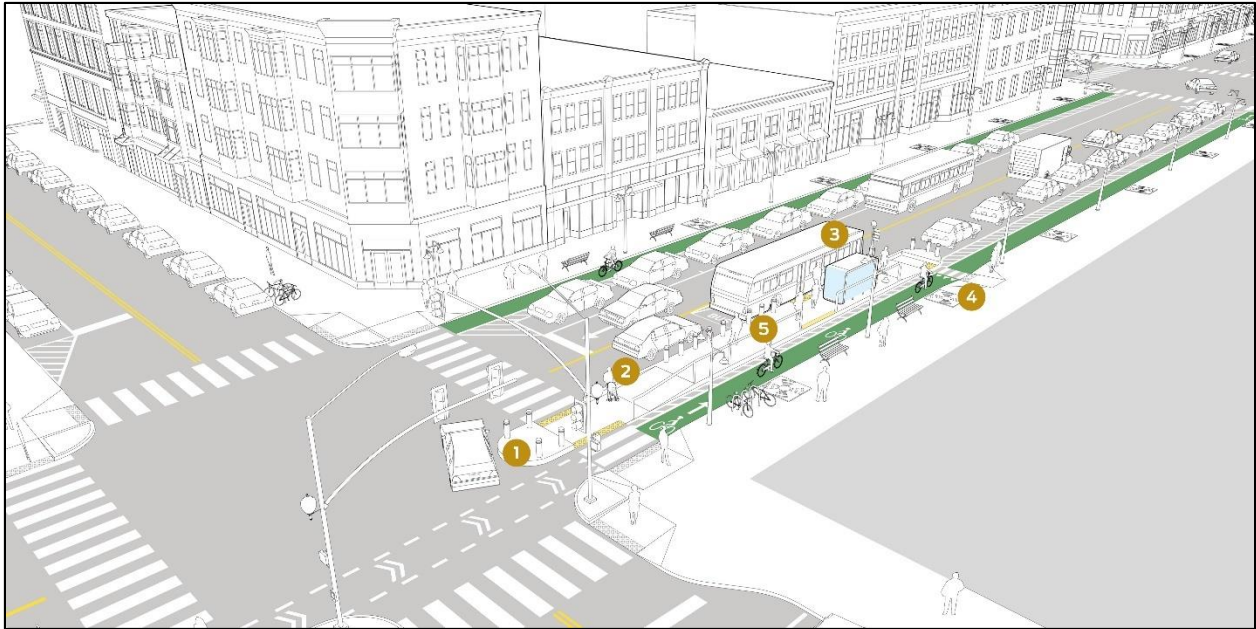

**Figure 45 |** Bus Boarding Island

Source: NACTO Transit Street Design Guide



**Figure 46 |** Bus Boarding Island (Raised Protected Bicycle Lane)

Source: NACTO Transit Street Design Guide

### 5.1.3.2 Shared Boarding Zone

If adequate right-of-way does not exist to provide a Bus Median Boarding Island and buses are permitted to stop within the travel lane, a shared boarding zone may be constructed to permit transit



vehicle boarding along a raised protected bicycle lane. This configuration allows the bicycle facility lanes to serve as the clear boarding/alighting area for transit vehicles when present and provides dedicated lanes for bicycles at all other times.

A shared boarding zone should raise the proposed bicycle facility to the level of the existing sidewalk. A ramp shall be provided at either end of the transit stop, with a slope of no more than 1:8. The width of the bicycle lane(s) should narrow to 4' per lane (8' total for a two-way bicycle facility) to encourage reduced bicycle speeds. Bicycle lanes shall be marked with green pavement markings throughout a shared boarding zone. Designated pedestrian crossings of the bicycle facility shall be marked similar to high-visibility crosswalks, with two 4", parallel solid white lines running perpendicular to bicycle flow, spaced at least 5' apart. 1' wide and 1' skip solid white lines shall be placed between these lines, running parallel to the direction of flow.

The use of temporary or modular platforms are permitted in lieu of curb modifications. Zicla® Vectorial® Modular Platform System (or similar) shall be used. It shall consist of dimensions as close as possible to the above guidance within manufacturer specifications.

All transit stop furniture shall be located within the sidewalk furnishing zone. If a transit shelter is located less than 3' from the bicycle facility, it shall face away from the bicycle lane(s). The bus stop flag shall be as close to the vehicular travel lane as possible, but outside of the bicycle lane(s).<sup>26</sup>

If a tactile warning surface is required at the transit stop, it shall be located outside of the bicycle lane.

An example of a Shared Boarding Zone for a protected bicycle lane is shown in **Figure 48**.

---

<sup>26</sup> NACTO *Transit Street Design Guide*

*This page intentionally left blank.*

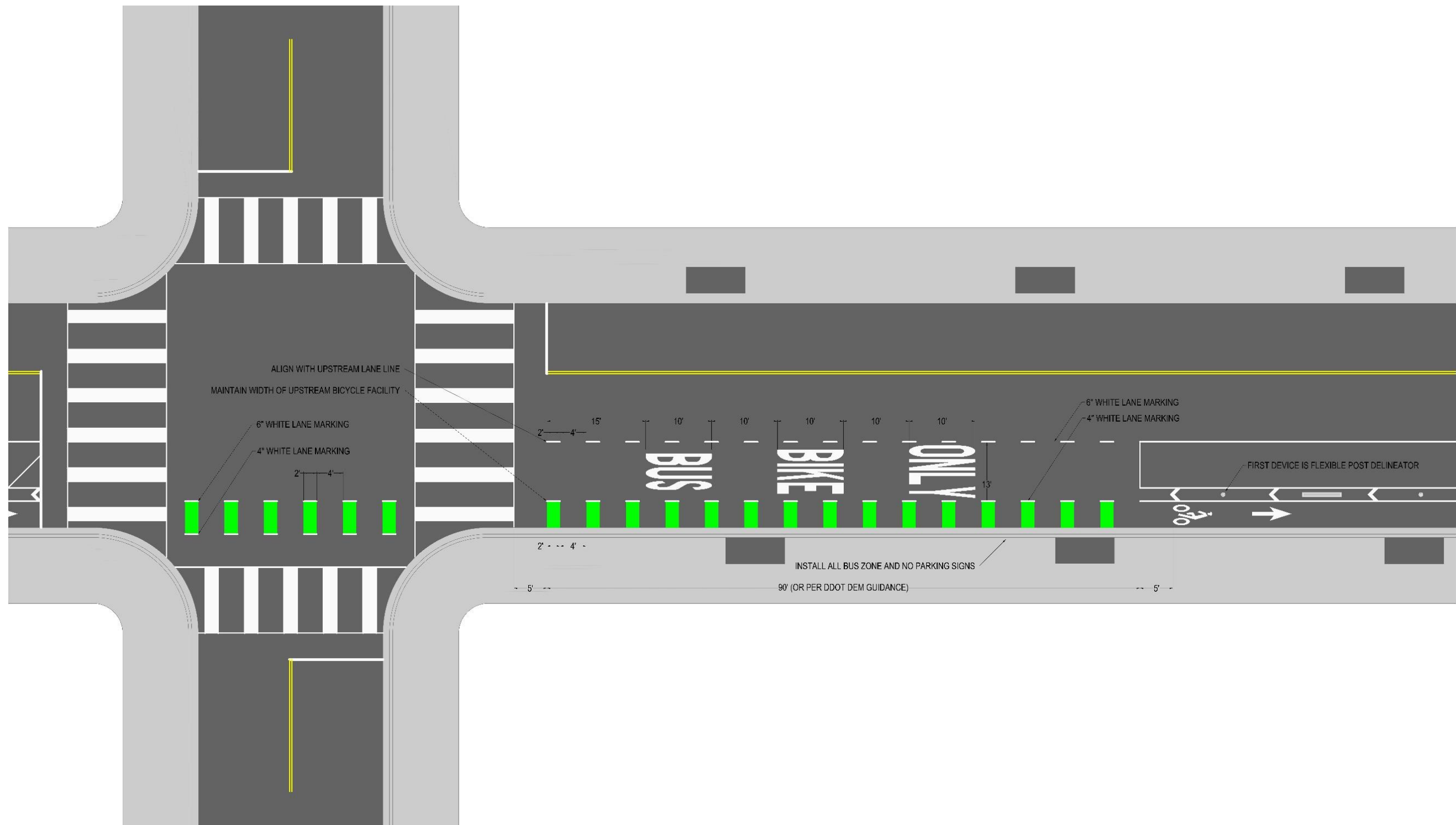

Figure 47 | Shared Bicycle Lane Transit Stop

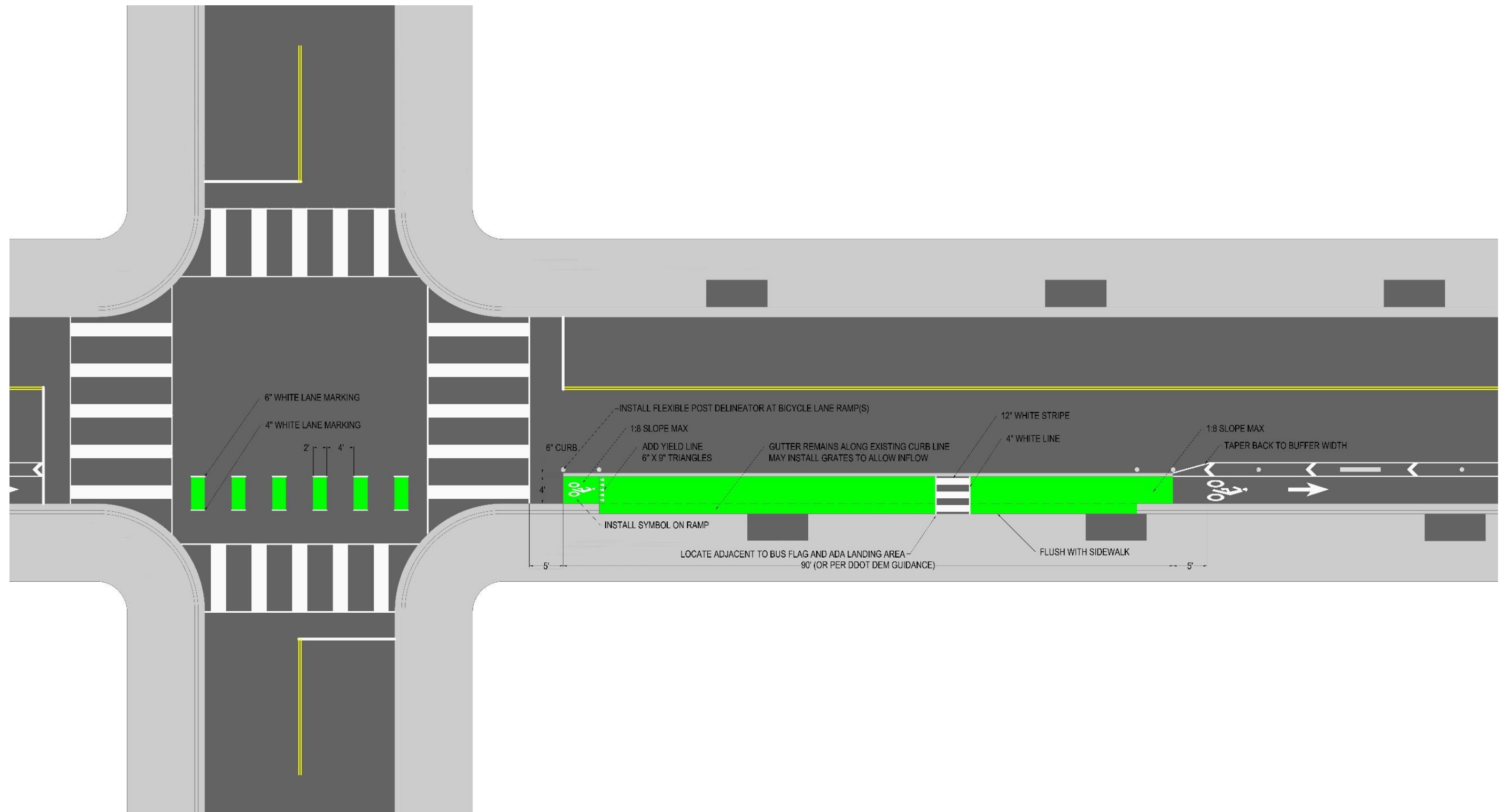

Figure 48 | Shared Boarding Zone

## 5.2 Shared-use Bicycle/Transit Facility

Shared bicycle and bus lanes are not a preferred configuration for the dedication of right-of-way. However, in some constrained situations, a shared lane may be used to facilitate the continuation of either dedicated bicycle lanes or dedicated bus lanes adjacent to the corridor of study.

Shared-use bicycle and bus lanes may be used in locations where both bus lanes and protected bicycle lanes are desired, but limited right of way prevents both concurrently. Within a shared bicycle-bus lane, bicycles are permitted to pass buses at stops, but buses are not permitted to pass bicycles.<sup>27</sup>

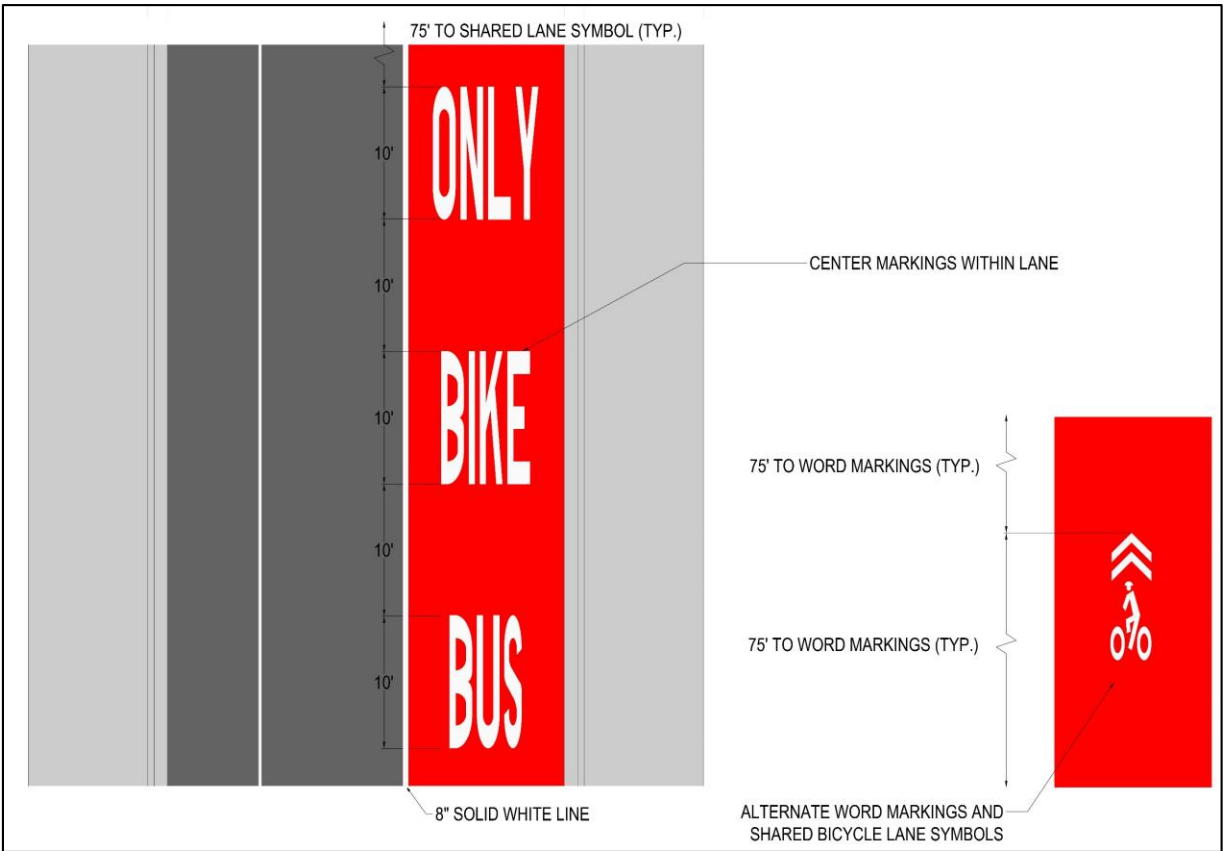

**Figure 49** | Shared-use Bicycle/Transit Lane on H Street NW

<sup>27</sup> NACTO *Transit Street Design Guide*



A shared bicycle-bus lane shall be painted red and striped with a 8" solid white line between vehicular travel lanes and the shared lane. A shared lane "Helmeted Bicyclist" symbol in addition to the words "BUS BIKE ONLY" shall be located with white thermoplastic pavement markings within the shared lane. Pavement markings typically repeat every 200 feet. An overhead sign shall not be used.



**Figure 50 | Shared Bicycle Transit Lanes**

### 5.2.1 Right Turn Lanes

If general purpose vehicles are permitted to make right-hand turns from the shared bicycle-bus lane, a modified R4-4 sign reading "BEGIN RIGHT TURN LANE [ARROW] YIELD TO BUSES AND BIKES" shall be placed on approach to the intersection (see **Figure 51**).

See the NACTO *Transit Streets Design Guide* for further details regarding transit lane treatments.



**Figure 51 | R4-4 (mod) Sign**

## **6 Typical Design Configurations**

**6.1 Shared Street and Contraflow Bicycle Lanes**

**6.2 Dedicated Bicycle Lanes**

**6.3 Buffered Bicycle Lanes (Parking Side)**

**6.4 Protected Bicycle Lanes**

**6.4.1 Without Parking**

**6.4.2 With Parking**

**6.5 Two-way Protected Bicycle Lanes**

**6.5.1 On Roadway**

**6.5.2 Off Roadway**

**6.6 Shared-use Bicycle/Transit Facility**

**6.7 Advisory Bicycle Lanes**

*This page intentionally left blank.*

## 6.1 Shared Street and Contraflow Bicycle Lanes

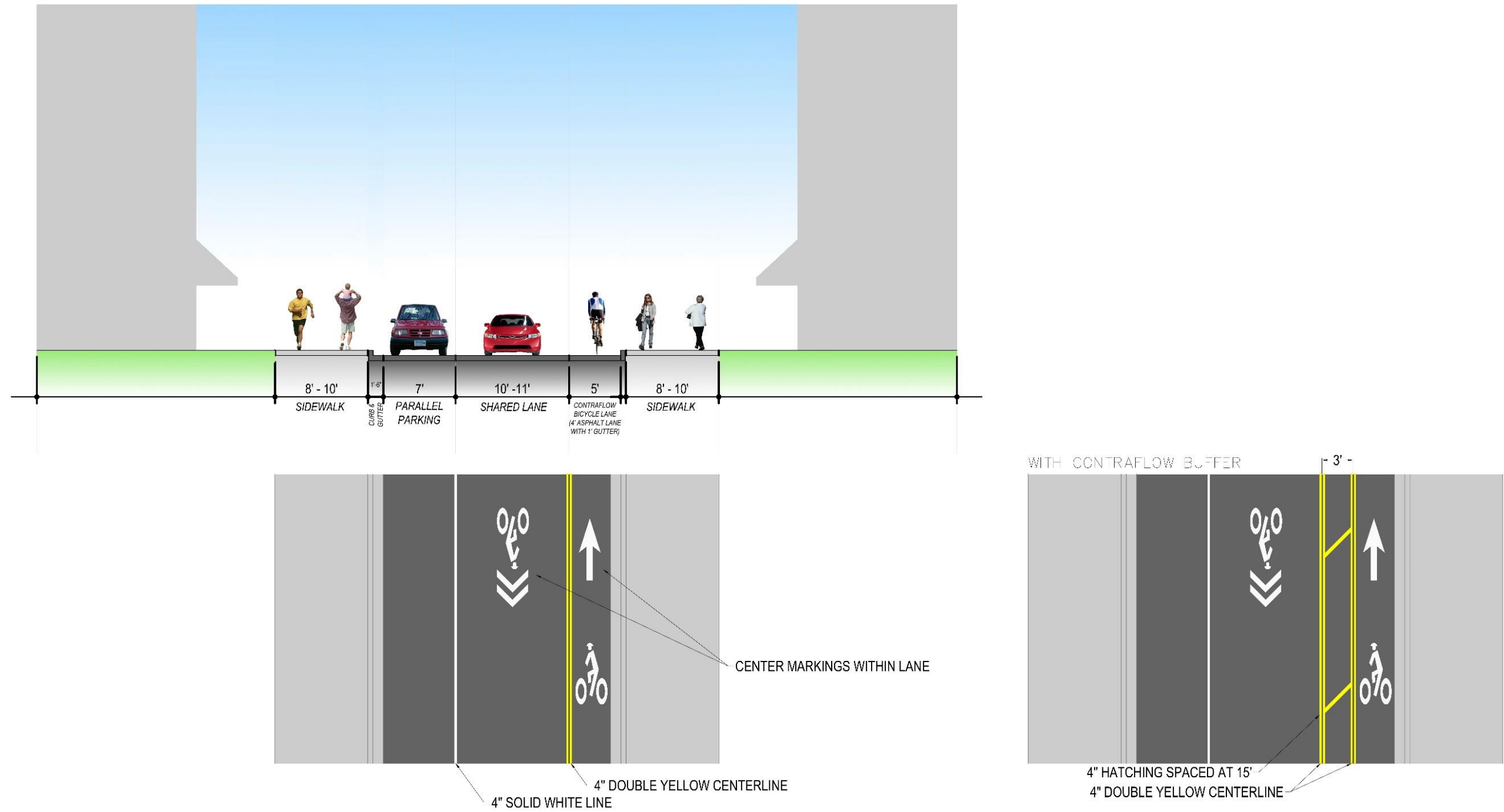

## 6.2 Dedicated Bicycle Lanes

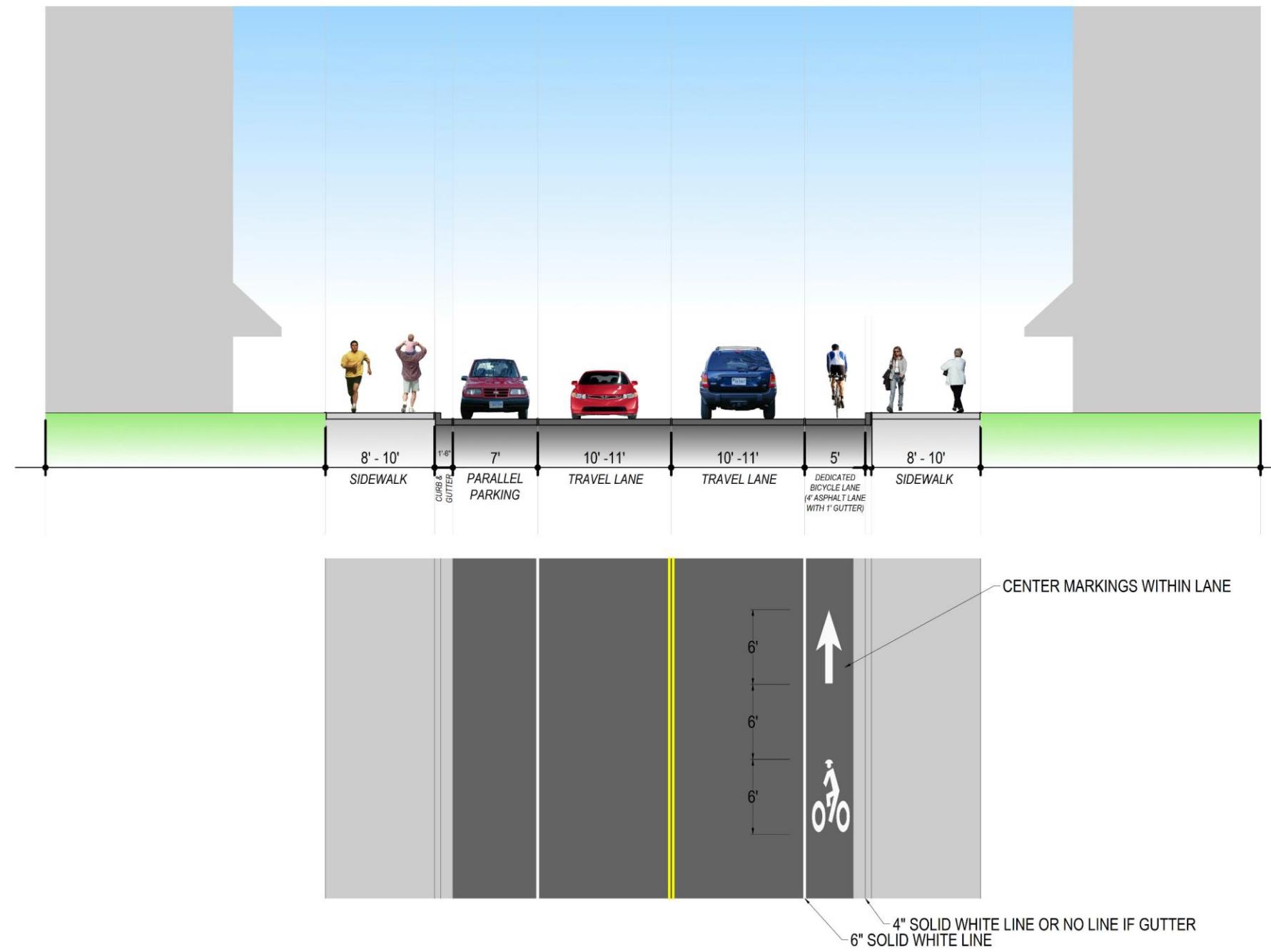



### 6.3 Buffered Bicycle Lanes (Parking Side)

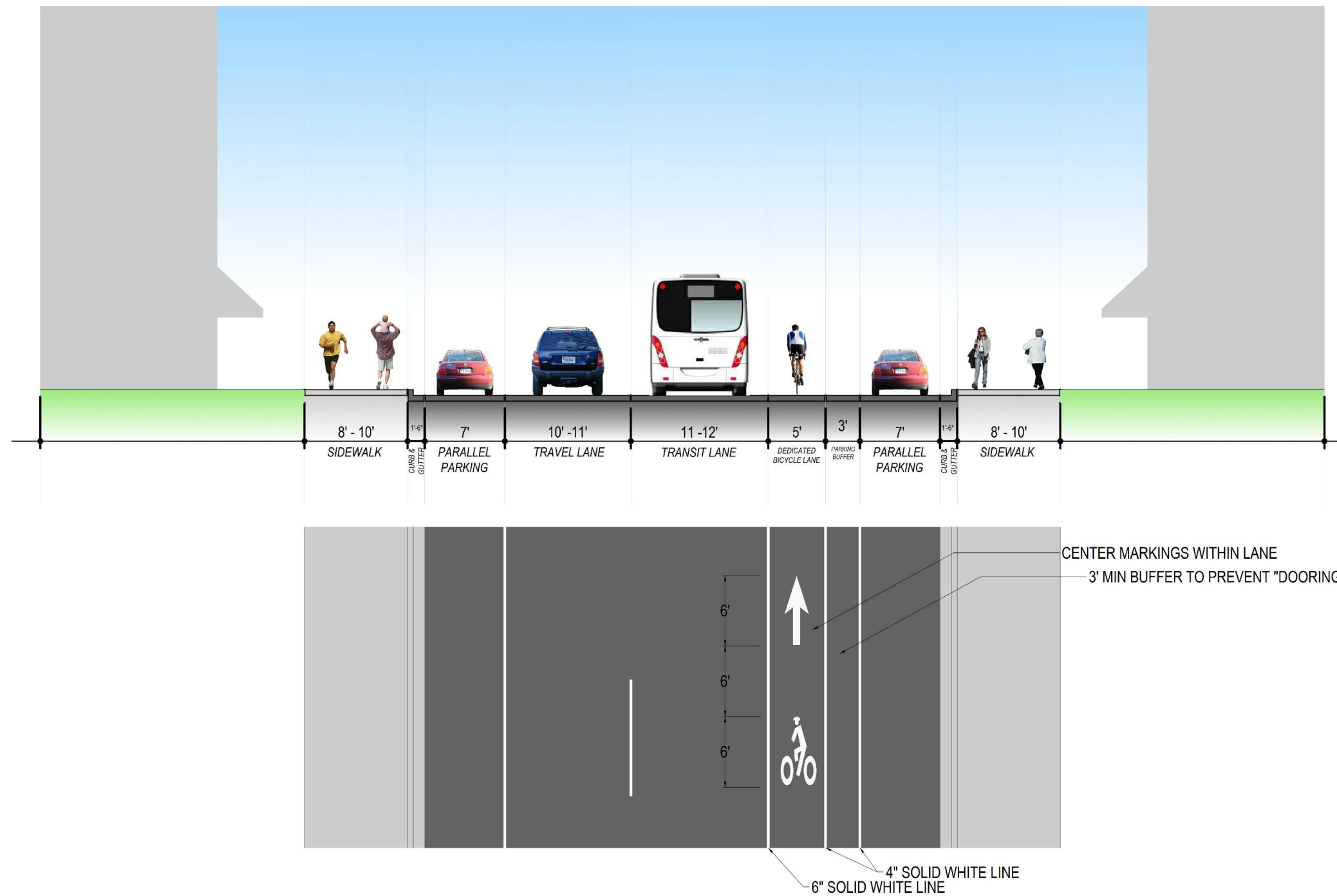

## 6.4 Protected Bicycle Lanes

### 6.4.1 Without Parking

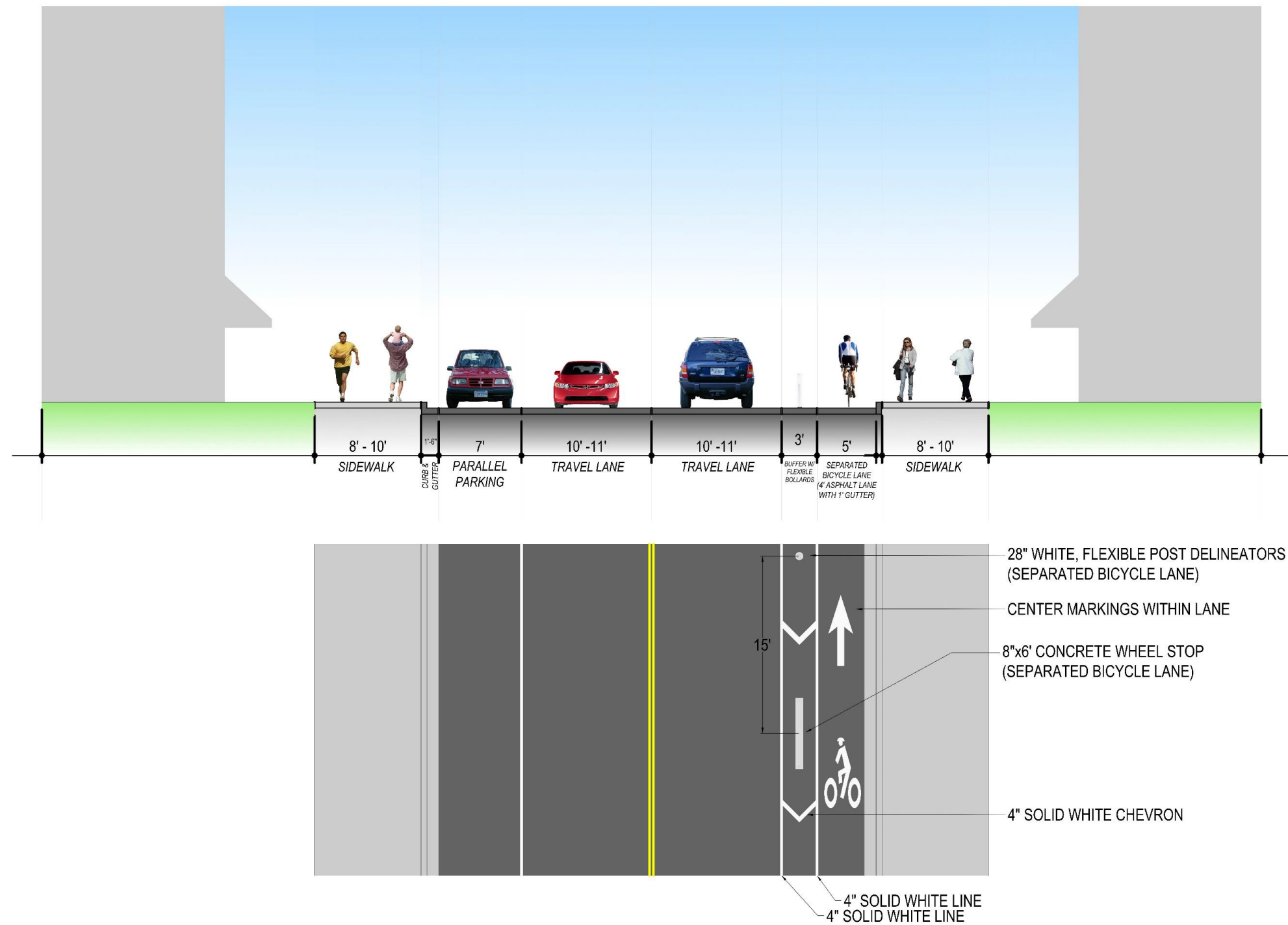

6.4.2 With Parking

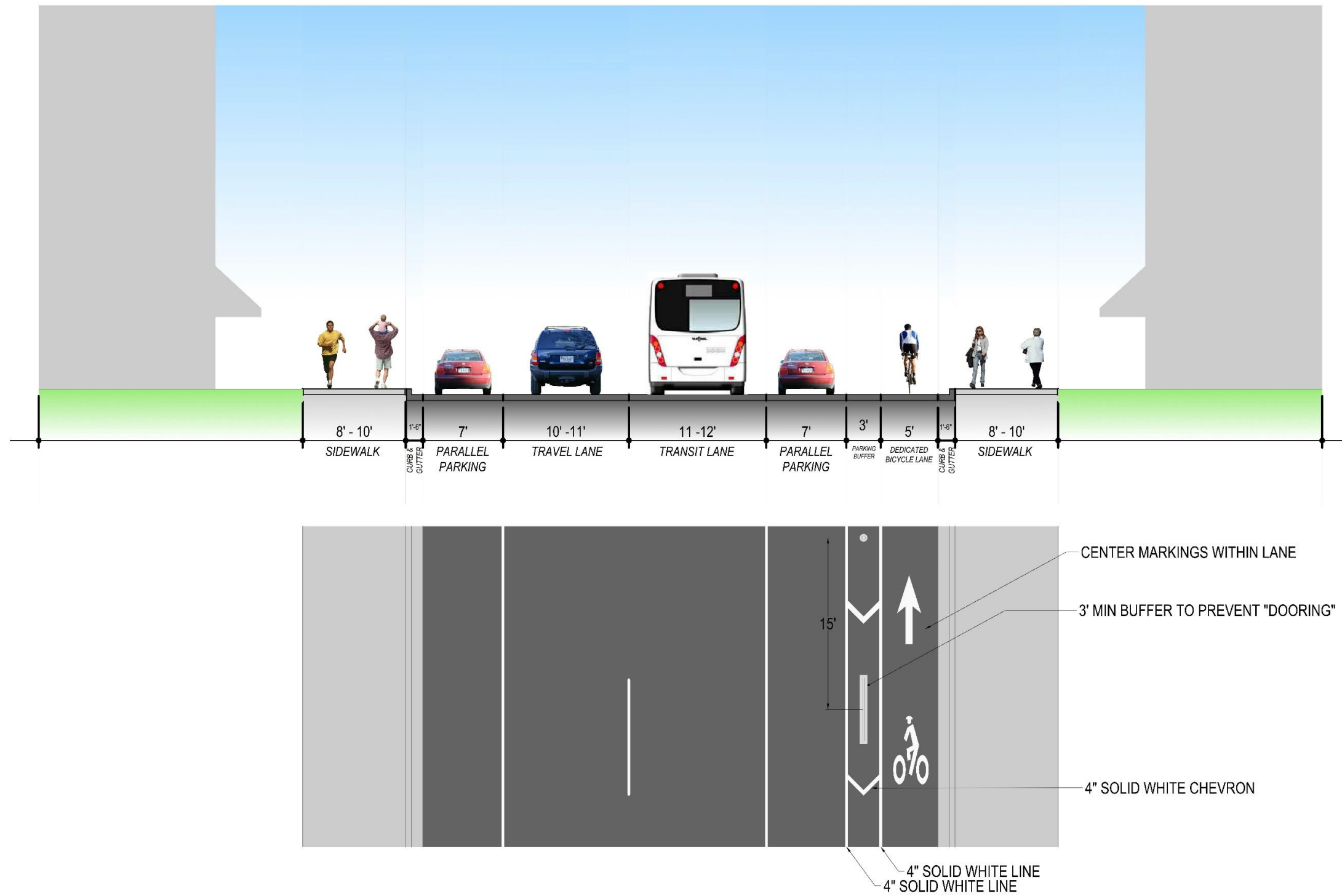

## 6.5 Two-way Protected Bicycle Lanes

### 6.5.1 On Roadway

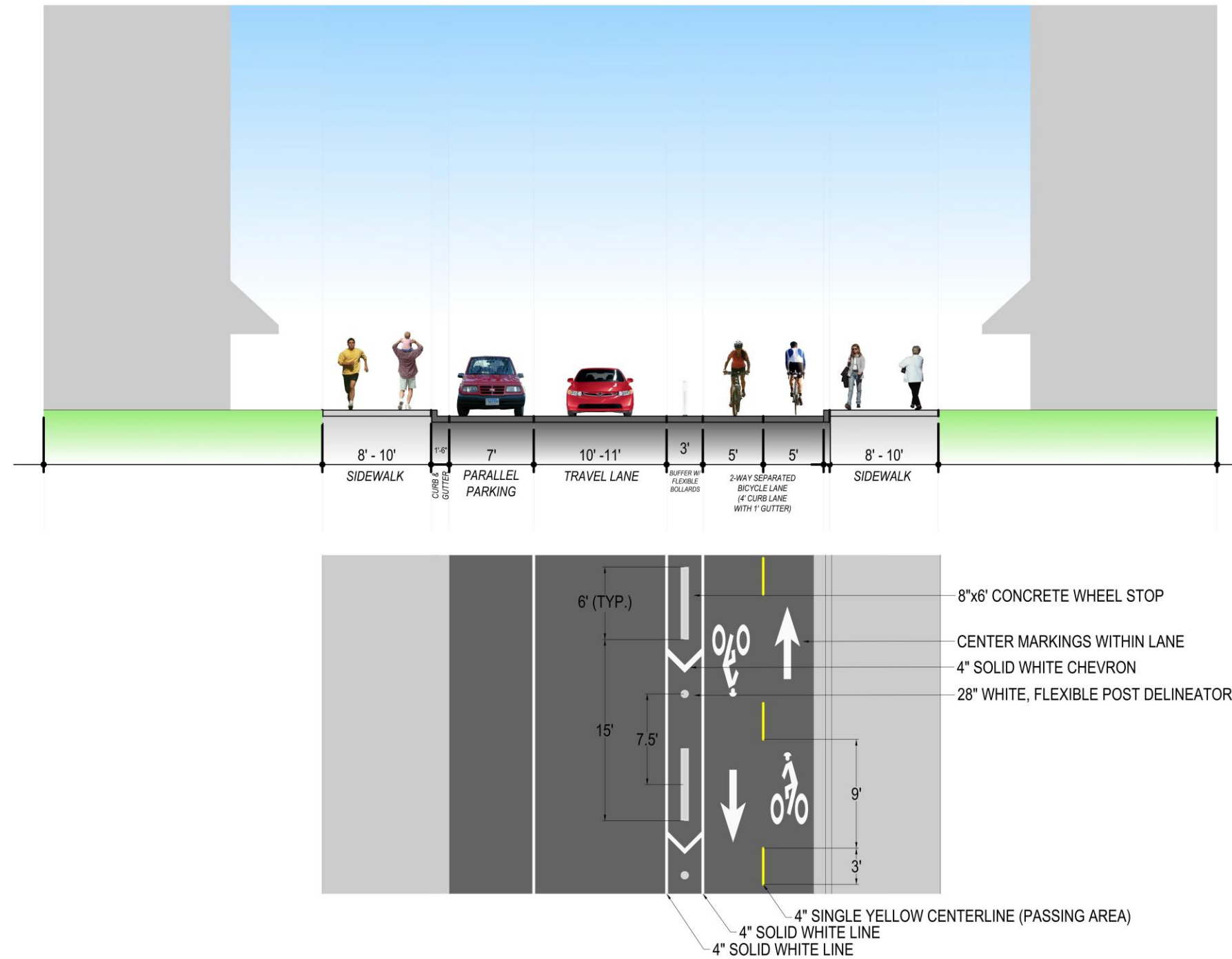

## 6.5.2 Off Roadway

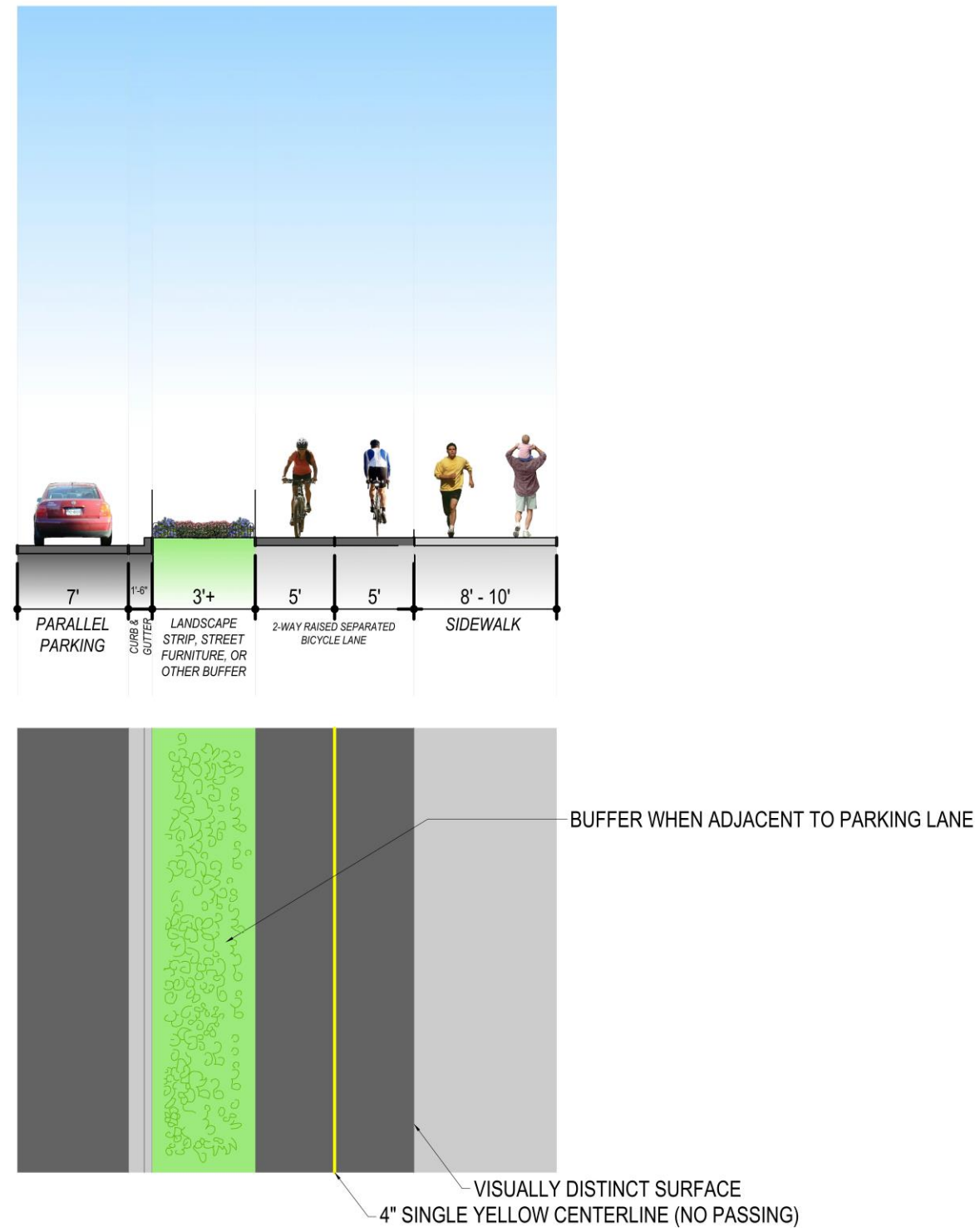



## 6.6 Shared-use Bicycle/Transit Facility

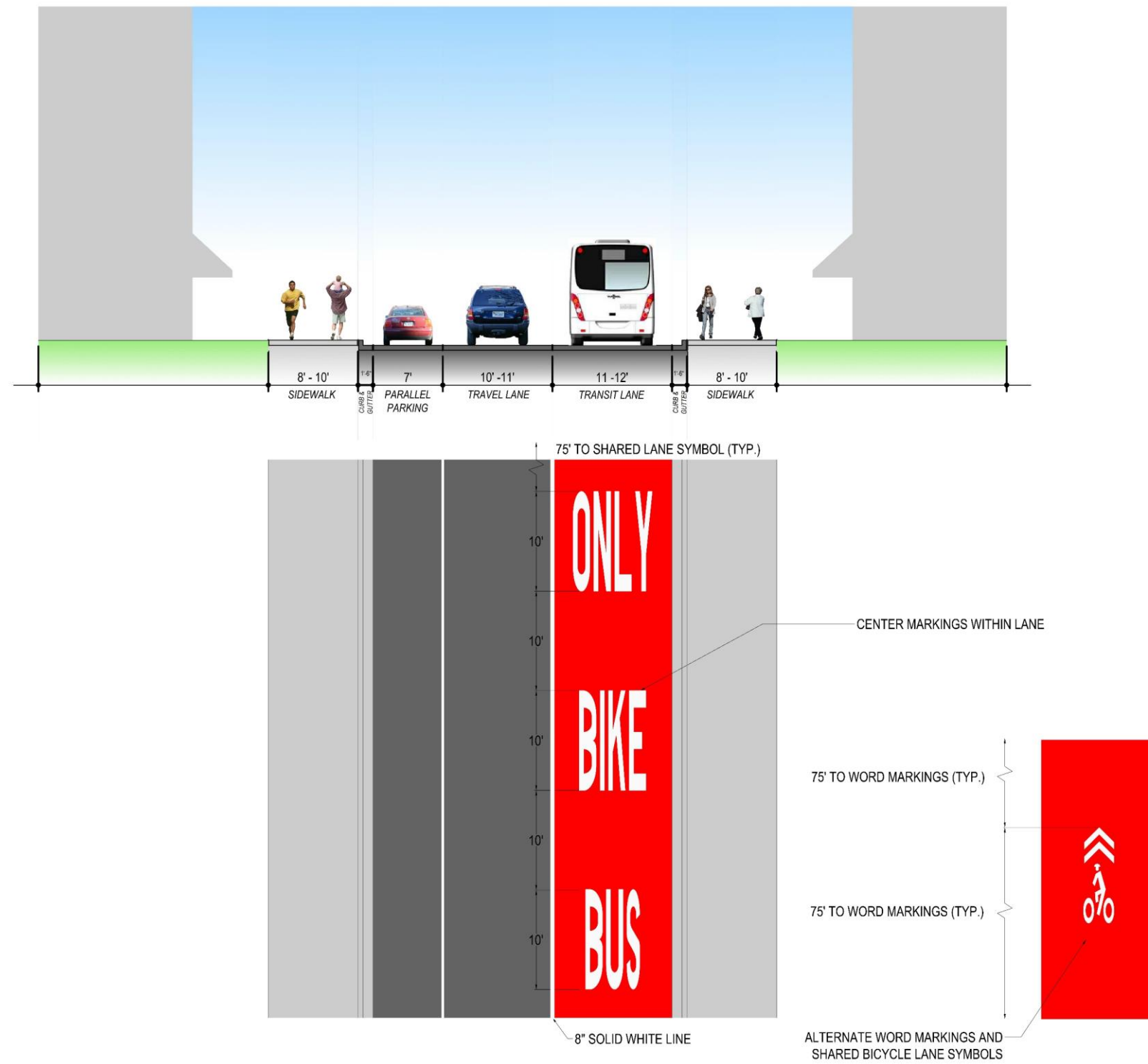

## 6.7 Advisory Bicycle Lanes

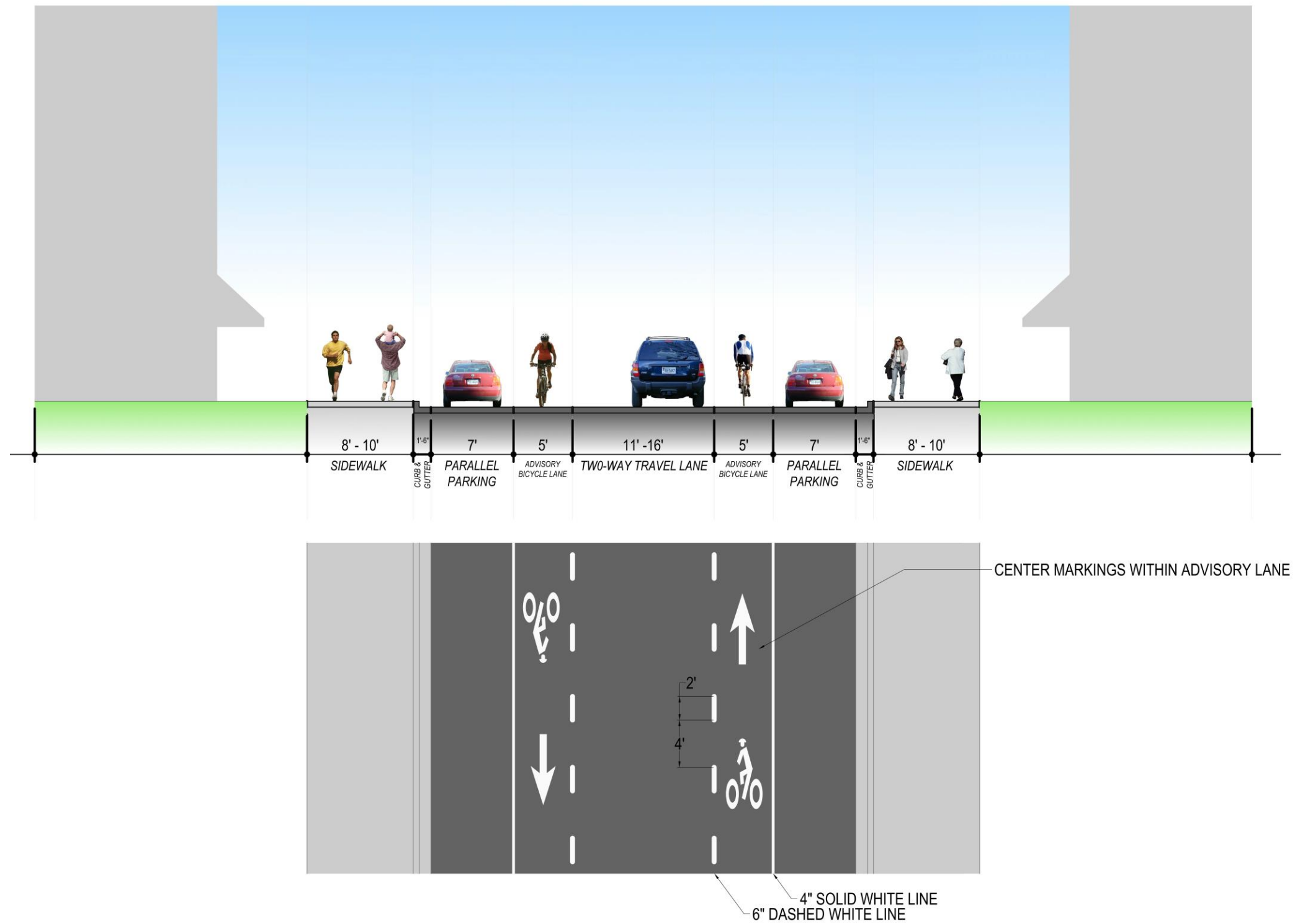

*This page intentionally left blank.*

## References

AASTHO *Guide for the Development of Bicycle Facilities* (2012)  
DDOT *Design and Engineering Manual* (2019)  
FHWA *Bikeway Selection Guide* (2019)  
FHWA *Separated Bike Lane Planning and Design Guide* (2015)  
*Manual on Uniform Traffic Control Devices* (2009)  
MassDOT *Separated Bike Lane Planning & Design Guide* (2015)  
NACTO *Transit Street Design Guide* (2016)  
NACTO *Urban Bikeway Design Guide, Second Edition* (2014)  
NACTO *Urban Street Design Guide* (2013)

## Acknowledgements

### DDOT

Zuxuan Deng (Traffic Engineering & Signal Division)  
Yi Zhao (Traffic Engineering & Signal Division)  
Sonela Ardekani (Traffic Engineering & Signal Division)  
Mike Goodno (Planning & Sustainability Division)  
Michael Alvino (Planning & Sustainability Division)  
Will Handsfield (Planning & Sustainability Division)  
Gilbert Solano (Planning & Sustainability Division)  
Derek Voight (Traffic Operations & Signal Division)  
Emily Dalphy (Vision Zero Office)  
Cesar Barreto (Diversity & Inclusion Office)

### Consultant Team (Kimley-Horn)

Geoff Giffin  
Daniel Markham  
David Capparuccini  
Stewart Robertson  
Mike Shindledecker