

# D.C. Temporary Traffic Control Manual

## Guidelines and Standards



### 2006 Edition

**d.**

DISTRICT DEPARTMENT OF TRANSPORTATION  
Traffic Services Administration

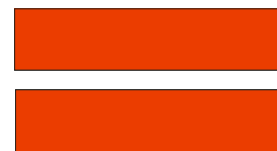

Government of the District of Columbia  
Anthony A. Williams, Mayor

Dotted line  
indicates edge of  
binder spine

**d.**

**D.C.  
Temporary Traffic Control Manual  
Guidelines and Standards**

**2006  
Edition**



<b>TABLE OF CONTENTS</b>		<b>Page</b>
<b>SECTION 1 - INTRODUCTION .....</b>		<b>1-1</b>
<b>SECTION 2 - GENERAL INFORMATION.....</b>		<b>2-1</b>
2.1	General.....	2-1
2.2	Responsibility .....	2-2
2.3	Training.....	2-3
2.4	Definitions of Words and Phrases in this Manual .....	2-4
2.5	Minimum Standards.....	2-13
2.6	Special Events, Holidays, Inaugurations .....	2-13
2.7	Abbreviations used on Traffic Control Devices .....	2-13
<b>SECTION 3- FUNDAMENTAL PRINCIPLES OF TEMPORARY TRAFFIC CONTROL .....</b>		<b>3-1</b>
3.1	Fundamental Principles.....	3-1
<b>SECTION 4 - TEMPORARY TRAFFIC CONTROL ELEMENTS .....</b>		<b>4-1</b>
4.1	Temporary Traffic Control Plans.....	4-1
4.2	Temporary Traffic Control Zones.....	4-3
4.3	Components of Temporary Traffic Control Zones .....	4-4
4.3.1	Advance Warning Area .....	4-4
4.3.2	Transition Area.....	4-6
4.3.3	Buffer Space Area .....	4-6
4.3.4	Activity Area .....	4-8
4.3.5	Termination Area .....	4-9
4.4	Tapers.....	4-9
4.5	Detours and Diversions.....	4-13
4.6	One-Lane, Two-Way Traffic Control.....	4-13
4.6.1	Flagger Method of One-Lane, Two-Way Traffic Control .....	4-14
4.6.2	Pilot Car Method of One-Lane, Two-Way Traffic Control .....	4-14
4.6.3	Temporary Traffic Control Signal Method of One-Lane, Two-Way Traffic Control.....	4-15
<b>SECTION 5 - PEDESTRIAN AND WORKER SAFETY.....</b>		<b>5-1</b>
5.1	Pedestrian Considerations.....	5-1
5.2	Worker Considerations .....	5-10
<b>SECTION 6 - FLAGGER CONTROL.....</b>		<b>6-1</b>
6.1	Qualifications for Flaggers .....	6-1
6.2	High-Visibility Clothing.....	6-1
6.3	Hand-Signaling Devices .....	6-2
6.4	Flagger Procedures.....	6-3
6.5	Flagger Stations .....	6-6
6.6	Traffic Spotters .....	6-8

<b>TABLE OF CONTENTS (Continued)</b>		<b>Page</b>
<b>SECTION 7 - TEMPORARY TRAFFIC CONTROL ZONE DEVICES</b> .....		<b>7-1</b>
7.1	Types of Devices.....	7-1
7.2	General Characteristics of Signs.....	7-1
7.3	Sign Placement.....	7-3
7.4	Sign Maintenance.....	7-6
7.5	Regulatory Sign Authority.....	7-6
7.6	Regulatory Sign Design.....	7-7
7.7	Regulatory Sign Applications.....	7-7
7.7.1	Advance Warning Signs.....	7-10
7.7.2	Special Regulatory Signs.....	7-12
7.7.3	Warning Signs: Function, Design, and Application.....	7-12
7.7.4	Position of Advance Warning Signs.....	7-14
7.7.5	Other Warning Signs.....	7-24
7.7.6	Special Warning Signs.....	7-24
7.8	Guide Signs.....	7-25
7.9	Detour Signs.....	7-27
7.10	Pilot Car Signs.....	7-28
7.11	Portable Changeable Message Signs.....	7-28
7.12	Arrow Panels.....	7-31
7.13	High-Level Warning Devices (Flag Trees).....	7-36
7.14	Channelizing Devices.....	7-36
7.14.1	Cones.....	7-40
7.14.2	Tubular Markers.....	7-41
7.14.3	Vertical Panels.....	7-42
7.14.4	Drums.....	7-42
7.14.5	Type III Barricades.....	7-43
7.14.6	Direction Indicator Barricades.....	7-45
7.14.7	Temporary Traffic Barriers as Channelizing Devices.....	7-45
7.14.8	Other Channelizing Devices.....	7-46
7.14.8.1	Temporary Raised Islands.....	7-46
7.14.8.2	Pavement Markings.....	7-47
7.14.8.3	Temporary Pavement Markings.....	7-48
7.14.8.4	Raised Pavement Markers.....	7-49
7.14.8.5	Delineators.....	7-49
7.15	Lighting Devices.....	7-50
7.15.1	Floodlights.....	7-50
7.15.2	Flashing Warning Beacons.....	7-51
7.15.3	Warning Lights.....	7-52
7.15.4	Steady-Burn Electric Lamps.....	7-53
7.15.5	Vehicle Warning Lights.....	7-53
7.16	Temporary Traffic Control Signals.....	7-54
7.17	Temporary Traffic Barriers.....	7-55
7.18	Crash Cushions.....	7-57

<b>TABLE OF CONTENTS (Continued)</b>		<b>Page</b>
7.19	Vehicle-Arresting Systems .....	7-60
7.20	Rumble Strips.....	7-60
7.21	Screens .....	7-61
7.22	Future and Experimental Devices.....	7-61
<b>SECTION 8 - TYPE OF TEMPORARY TRAFFIC CONTROL</b>		
	<b>ZONE ACTIVITIES .....</b>	<b>8-1</b>
8.1	Typical Applications.....	8-1
8.2	Work Duration .....	8-1
8.3	Location of Work and Roadway Characteristics .....	8-5
8.4	Modifications to Fulfill Special Needs .....	8-6
8.5	Work off of the Roadway .....	8-7
8.6	Work on the Shoulder with No Encroachment.....	8-8
8.7	Work on the Shoulder with Minor Encroachment.....	8-10
8.8	Work within the Median.....	8-10
8.9	Work within the Traveled Way of Two-Lane Highways .....	8-10
8.9.1	Work within the Traveled Way of Urban Streets.....	8-11
8.9.2	Work within the Traveled Way of Multilane, Non-access Controlled Highways .....	8-12
8.9.3	Work within the Traveled Way at Intersections.....	8-14
8.9.4	Work within the Traveled Way of Expressways and Freeways.....	8-16
8.10	Two-Lane, Two-Way Traffic on One Roadway of a Normally Divided Highway.....	8-17
8.11	Crossovers.....	8-18
8.12	Interchanges .....	8-18
8.13	Movable Barriers .....	8-19
8.14	Work in the Vicinity of Highway-Rail Grade Crossings.....	8-19
8.15	Control of Traffic Through Incident Areas.....	8-20
8.16	Work During Inclement Weather.....	8-21
<b>SECTION 9 - TYPICAL APPLICATIONS .....</b>		<b>9-1</b>
<b>SECTION 10 – CRANE TYPICAL DETAILS .....</b>		<b>10-1</b>
10.1	Crane Sizes.....	10-1
10.2	Crane Typicals .....	10-3

**LIST OF FIGURES**

**Page**

Figure 4-1. Five Parts of Temporary Traffic Control Zone ..... 4-5

Figure 5-1. Crosswalk Closure and Pedestrian Detour ..... 5-3

Figure 5-2. Sidewalk Closure and Bypass Sidewalk Operation ..... 5-4

Figure 5-3. Temporary Covered Walkway with Fencing at Intersection Corner ..... 5-7

Figure 5-4. Temporary Covered Walkway at Mid-Block..... 5-8

Figure 6-1. Use of Hand Signaling Devices by Flagger ..... 6-4

Figure 7-1. Height And Lateral Location Of Signs-Typical Installations ..... 7-4

Figure 7-2. Commonly Used Regulatory Signs..... 7-8

Figure 7-4. Warning Signs in Temporary Traffic Control Zones..... 7-16

Figure 7-4. Warning Signs in Temporary Traffic Control Zones..... 7-17

Figure 7-4. Warning Signs in Temporary Traffic Control Zones..... 7-18

Figure 7-5. Exit Open and Closed and Detour Signs..... 7-21

Figure 7-6. Arrow Panel displays ..... 7-33

Figure 9-1. Typical Application: Closures on Curb Lanes ..... 9-5

Figure 9-2. Typical Application: Mobile or Short Duration..... 9-7

Figure 9-3. Typical Application: Mobile Operations on a High-Speed Road ..... 9-9

Figure 9-4. Typical Application: Moderate Duration or Stationary Operation ..... 9-11

Figure 9-5. Typical Application: Closure in the Center of a Local or Low-Volume Road..... 9-13

Figure 9-6. Typical Application: Lane Closure on a Minor Street ..... 9-15

Figure 9-7. Typical Application: Road Closure and Detour for One Travel Direction. 9-17

Figure 9-8. Typical Application: Road Closure and Detour for Two Travel Directions ..... 9-19

Figure 9-9. Typical Application: Right Lane Closure at Far Side of the Intersection... 9-21

Figure 9-10. Typical Application: Left Lane Closure at Far Side of the Intersection... 9-23

Figure 9-11. Typical Application: Multiple Closures at Intersection ..... 9-25

Figure 9-12. Typical Application: Closure in Center of Intersection ..... 9-27

Figure 9-13. Typical Application: Closure at Side of Intersection (With No Parking Lanes)..... 9-29

Figure 9-14. Typical Application: Closure at Side of Intersection (With Parking Lanes) ..... 9-31

Figure 9-15. Typical Application: Interior Lane Closure on Multi-Lane Roadway or Street..... 9-33

Figure 9-16. Typical Application: Merging Taper Followed by Shifting Taper on Multilane Road..... 9-35

Figure 9-17. Typical Application: Multi-leg Intersection..... 9-37

Figure 9-18. Typical Application: Sidewalk Closure and Bypass Sidewalk Operation 9-39

Figure 9-19. Typical Application: Crosswalk Closures and Pedestrian Detours..... 9-41

Figure 9-20. Typical Application: Covered Pedestrian Walkways–Mid-Block Locations ..... 9-42

Figure 9-21. Typical Application: Covered Pedestrian Walkways–Corner Locations at Four -Way Intersections ..... 9-43

Figure 9-22. Typical Application: Construction Dumpster Located in Parking Lane... 9-44

**LIST OF FIGURES**

**Page**

Figure 9-23. Typical Application: Construction Dumpster Located in Parking Lane (One-Way Road) ..... 9-46

Figure 9-24. Typical Application: Construction Dumpster Located in Parking Lane... 9-47

Figure 9-24. Typical Application: Traffic Circle with Outer-most Lane Closure ..... 9-48

Figure 9-25. Typical Application: Traffic Circle with Center Lane Closure ..... 9-49

Figure 9-26. Typical Application: Traffic Circle with Inner-most Lane Closure..... 9-50

Figure 10-1. Typical Details for 40 Ton Crane..... 10-4

Figure 10-2. Typical Details for 50 Ton Crane..... 10-4

Figure 10-3. Typical Details for 70 Ton Crane..... 10-5

Figure 10-4. Typical Details for 120 Ton Crane..... 10-6

Figure 10-5. Typical Details for 150 Ton Crane..... 10-7

Figure 10-6. Typical Details for 220 Ton Crane..... 10-8

Figure 10-7. Crane Typical for a Two-Way St./Two Lane Closure/Lane Shift TCP 1. 10-9

Figure 10-8. Crane Typical for a Two Lane Closure TCP2 ..... 10-10

Figure 10-9. Typical Details for a One-Way St. Two Lane Closure TCP 3..... 10-11

Figure 10-10. Typical Detail for a Two-Way St. One Lane Closure/Flagger Operation TCP 4..... 10-12

Figure 10-11 Crane Typical for a Two-Way St. Right Lane Closure TCP 5 ..... 10-13

**LIST OF TABLES**

**Page**

Table 2-1. Acceptable Abbreviations ..... 2-15

Table 2-2. Abbreviations that are acceptable only with a Prompt Word..... 2-16

Table 2-3. Unacceptable Abbreviations..... 2-17

Table 4-1. Length of Longitudinal Buffer Space..... 4-7

Table 4-2. Taper Length Criteria for Temporary Traffic Control Zones..... 4-10

Table 6-1. Distance of Flagger Station in Advance of the Work Space ..... 6-6

Table 7-1. Arrow Panel Display Standards..... 7-34

Table 7-2. Spacing of Channelizing Devices..... 7-40

Table 9-1. Symbols on Typical Application Diagrams ..... 9-3

**APPENDICES**

- Appendix A Functional Classification of Streets in the District of Columbia
- Appendix B Traffic Control Plan Guidelines
- Appendix C Typical Work Zone and Crane Set Up Photos
- Appendix D Key Telephone Numbers

**LIST OF ACRONYMS**

AASHTO	American Association of State Highway and Transportation Officials
ATSSA	American Traffic Safety Services Association
CBD	Central Business District
CFR	Code of Federal Regulations
DCMR	District of Columbia Municipal Regulations
DDOT	District Department of Transportation
FHWA	Federal Highway Administration
IPMA	Infrastructure Project Management Administration
ISEA	International Safety Equipment Association
MUTCD	Manual on Uniform Traffic Control Devices
NCHRP	National Cooperation Highway Research Program
PCMS	Portable Changeable Message Sign
PSMA	Public Space Management Administration
TCPs	Traffic Control Plans
TMA	Truck Mounted Attenuator
TSA	Traffic Services Administration
TTC	Temporary Traffic Control
TTCP	Temporary Traffic Control Plans
USC	United States Code
UVC	Uniform Vehicle Code



**District of Columbia  
Temporary  
Traffic  
Control  
Manual  
Guidelines and Standards**

**2006 Edition**



---

**DISTRICT DEPARTMENT OF TRANSPORTATION  
Traffic Services Administration**





District Department of Transportation  
Government of the District of Columbia  
Frank D. Reeves Municipal Center  
2000 14th Street NW  
6th Floor  
Washington, DC 20009

Web addresses:  
DDOT: <http://ddot.dc.gov>

## **District of Columbia Temporary Traffic Control Manual**

The District Department of Transportation is publishing this complete revision of the *District of Columbia Temporary Traffic Control Manual*, effective July 2006. This manual replaces the previous issue of the *DC Work Area Traffic Control Manual 2000*.

This Manual is the District of Columbia's version of Part 6 of the Manual on Uniform Traffic Control Devices (MUTCD) 2003 edition and either meets or exceeds the requirements for the temporary traffic control established by the Federal Highway Administration. This manual may also be accessed on the DC Department of Transportation web site at <http://www.DDOT.dc.gov>. Future revisions to this manual will be posted on the web site only and it will be the responsibility of the holder of this manual to periodically check the web site and replace revised sections.

Temporary traffic control installations shall be reviewed daily to ensure the functionality of the temporary traffic control devices and compliance to this Manual. These reviews shall be documented on a weekly basis including detailed information as warranted for the type of operation, using the *Daily Checklist for Temporary Traffic Control* form and the *Field Inspection Report* form supplied in the next two pages.



**DAILY CHECK LIST FOR TEMPORARY TRAFFIC CONTROL**

- All devices meet specifications and quality standards.
- All signs are properly installed and legible.
- Arrow displays and Portable Changeable Message Signs properly aligned and maintained.
- Proper taper and buffer lengths established.
- Channelized devices are clean, aligned, and properly spaced.
- Flaggers certified, properly equipped and using hand signals.
- Temporary barrier and attenuators properly installed and maintained in serviceable condition.
- Inapplicable traffic control devices removed when not required.
- Pavement markings in place at end of the work shift.
- Day and night drive-through inspections conducted and logged or recorded.

Checklist reviewed by:

---

(Name)

Location: \_\_\_\_\_

Date: \_\_\_\_\_



**Field Inspection Report**

**DDOT - Traffic Services Administration**

Inspected By: \_\_\_\_\_

Date: \_\_\_\_\_ Time: \_\_\_\_\_ Weather: \_\_\_\_\_

Worksite Location: \_\_\_\_\_

Public Space Job: \_\_\_\_\_ IPMA Job: \_\_\_\_\_

Ward Number: \_\_\_\_\_ Quadrant of the City: \_\_\_\_\_

Type of Work Performed: \_\_\_\_\_

In Travel Lane: \_\_\_\_\_

General Contractor: \_\_\_\_\_ SubContractor: \_\_\_\_\_

Contact Person: \_\_\_\_\_ Contact Person: \_\_\_\_\_

Permit Number: \_\_\_\_\_ Citation: \_\_\_\_\_ Code: \_\_\_\_\_ Photos: \_\_\_\_\_

Category	Rating			Observations/Corrective Actions S=Satisfactory U=Unsatisfactory N/A=Not Applicable	Abatement Date If corrective actions needed
	S	U	N/A		
<b>Traffic Control</b>					
Attenuator					
Barricades					
Barriers					
Cones					
Drums					
Flaggers					
End Treatment					
Lights					
Markings					
Sand Barrels					
Signs					
Sign Stands					
Sight Distance					
<b>Worksite</b>					
Excavation					
Confined Space					
Housekeeping					

**Comments:** \_\_\_\_\_

\_\_\_\_\_

\_\_\_\_\_

\_\_\_\_\_

\_\_\_\_\_

\_\_\_\_\_





**SECTION 1 - INTRODUCTION****Standard:**

Traffic control devices shall be defined as all signs, signals, markings, and other devices used to regulate, warn, or guide traffic, placed on, over, or adjacent to a street, highway, pedestrian facility, or bikeway by authority of a public agency having jurisdiction.

Part 6 of the *Manual On Uniform Traffic Control Devices<sup>i</sup>* (MUTCD) is reproduced and modified here as a separate publication to meet the special demand for uniform standards for temporary traffic control during construction, maintenance operations and special events on streets and highways in the District of Columbia.

The Manual on Uniform Traffic Control Devices (MUTCD) is incorporated by reference in 23 Code of Federal Regulations (CFR), Part 655, Subpart F and shall be recognized as the national standard for traffic control devices on all public roads open to public travel in accordance with 23 U.S.C. 109(d) and 402(a). The policies and procedures of the Federal Highway Administration (FHWA) to obtain basic uniformity of traffic control devices shall be described in 23 CFR 655, Subpart F. The *Final Rule on Work Zone Safety and Mobility<sup>ii</sup>* was published on September 9, 2004, in the *Federal Register*. All state and local governments that receive federal-aid funding are required to comply with the provisions of this rule no later than October 12, 2007. This rule updates and broadens the former regulation at 23 CFR 630 Subpart J.”

Any traffic control device design or application provision contained in this Manual shall be considered to be in the public domain. Traffic control devices contained in this Manual shall not be protected by a patent or copyright, except for the Interstate Shield and any other items owned by the FHWA.

The U.S. Secretary of Transportation, under authority granted by the Highway Safety Act of 1966, decreed that traffic control devices on all streets and highways open to public travel in accordance with United States Code (U.S.C.) Title 23 109(d) and 402(a) in each State shall be in substantial conformance with the Standards issued or endorsed by the FHWA.

**Guidance:**

*The need for standard controls is especially acute during roadway temporary traffic control operations. Abnormal conditions are the rule, and therefore, traffic is particularly dependent on design, placement, and uniformity of traffic control devices to direct and guide it safely and efficiently through what would otherwise be hazardous areas. The constantly shifting and changing nature of work zone activity on or adjacent to the roadway may require frequent readjustments of traffic control devices in order to handle new situations. Thus, the proper and adequate placement of standard highway*

*signs, signals, pavement markings, channelizing devices, and traffic control devices on roadways in work zones is a continuous responsibility of officials having authority and jurisdiction over the particular roadway. This responsibility includes periodic daytime and nighttime inspection of existing devices and conditions throughout the duration of the temporary traffic control operation.*

*This Manual is issued to promote a uniform standard of traffic control associated with SPECIAL EVENTS, INCIDENT MANAGEMENT, and WORK AREA PROTECTION along the streets and highways of the District of Columbia. The standards, policies, and objectives contained in this Manual are intended to furnish information and guidance to personnel authorized to do work on the highway right of way and are not intended to establish a legal requirement for installation. Good engineering judgment must be used to arrive at the best traffic controls for a particular worksite, depending on the nature of the activity, location and duration of work, type of roadway, traffic volume and speed, and potential hazard. Thus, while this Manual provides guidelines for design and application of traffic control devices, the Manual is not a substitute for engineering judgment.*

*It should be recognized that it is not feasible to cover every conceivable situation. The objective of this Manual is to illustrate many of the typical worksites and to describe many common conditions encountered. When circumstances occur which are not specifically covered in this Manual, or which require modification of the instructions contained herein, the judgment of the various levels of operating supervisors must be relied upon to meet the basic objectives. When warranted, the appropriate District Department of Transportation Engineer should be consulted to select or tailor the proper traffic control devices.*

*Nothing contained herein is intended to abridge or disclaim the Manual on Uniform Traffic Control Devices, but rather to augment and to supplement for the safety of the traveling public.*

Support:

23 CFR, Part 655.603 adopts the MUTCD as the national standard for any street, highway, or bicycle trail open to public travel in accordance with 23 U.S.C. 109(d) and 402(a). The “Uniform Vehicle Code (UVC)” is one of the documents referenced in the MUTCD. The UVC contains a model set of motor vehicle codes and traffic laws for use throughout the United States. The States are encouraged to adopt Section 15-117 of the UVC, which states that “No person shall install or maintain in any area of private property used by the public any sign, signal, marking, or other device intended to regulate, warn, or guide traffic unless it conforms to the State manual and specifications adopted under Section 15-104.” Section 15-104 of the UVC adopts the MUTCD as the standard for conformance.

The Standard, Guidance, Option, and Support material described in this edition of the D.C. Temporary Traffic Control Manual provides the transportation professional with the

information needed to make appropriate decisions regarding the use of traffic control devices on streets and highways. The material in this edition is organized to better differentiate between Standards that must be satisfied for the particular circumstances of a situation; Guidance that should be followed for the particular circumstances of a situation; Options that may be applicable for the particular circumstances of a situation; and Support that is informational.

Throughout this Manual the headings Standard, Guidance, Option, and Support are used to classify the nature of the text that follows. Figures, tables, and illustrations supplement the text and might constitute a Standard, Guidance, Option, or Support. The user needs to refer to the appropriate text to classify the nature of the figure, table, or illustration.

**Standard:**

**When used in this Manual, the text headings shall be defined as follows:**

- **Standard - a statement of required, mandatory, or specifically prohibitive practice regarding a traffic control device. All standards are labeled, and the text appears in bold large type. The verb *shall* is typically used. Standards are sometimes modified by Options.**
- *Guidance - a statement of highly recommended practice in typical situations, with deviations allowed if engineering judgment or engineering study indicates the deviation to be appropriate. These deviations shall be properly documented when not following guidance stipulations. All Guidance statements are labeled and the text appears in large italicized type. The verb 'should' is typically used. Guidance statements are sometimes modified by Options.*
- Option - a statement of practice that is a permissive condition and carries no requirement or recommendation. Options may contain allowable modifications to a Standard or Guidance. All Option statements are labeled, and the text is underlined. The verb *may* is typically used.
- Support - an informational statement that does not convey any degree of mandate, recommendation, authorization, prohibition, or enforceable condition. Support statements are labeled, and the text appears in regular font. The verbs *shall*, *should*, and *may* are not used in Support statements.



## **SECTION 2 - GENERAL INFORMATION**

### **2.1 GENERAL**

Support:

When the normal function of the roadway is suspended, temporary traffic control planning provides for continuity of the movement of motor vehicle, bicycle, and pedestrian traffic; transit operations; and access to property and utilities.

The primary function of temporary traffic control is to provide for the safe and efficient movement of vehicles, bicyclists, and pedestrians through or around temporary traffic control zones while reasonably protecting workers and equipment.

Of equal importance to the public traveling through the temporary traffic control zone is the safety of workers performing the many varied tasks within the work space. Temporary traffic control zones present constantly changing conditions that are unexpected by the road user. These create an even higher degree of vulnerability for the workers on or near the roadway (see Section 5 on Pedestrian and Worker Safety). At the same time, the temporary traffic control zone provides for the efficient completion of whatever activity interrupted the normal use of the roadway.

Consideration for road user safety, worker safety, and the efficiency of road user flow is an integral element of every temporary traffic control zone, from planning through completion. A concurrent objective of the temporary traffic control is the efficient construction and maintenance of the highway.

No one set of temporary traffic control devices can satisfy all conditions for a given project. At the same time, defining details that would be adequate to cover all applications is not practical. Instead, Part 6 of the MUTCD displays typical applications that depict common applications of temporary traffic control devices. The temporary traffic control selected for each situation depends on type of highway, road user conditions, duration of operation, physical constraints, and the nearness of the work space to road users.

Improved road user performance might be realized through a well-prepared public relations effort that covers the nature of the temporary traffic control zone, the time and duration of its execution, the anticipated effects upon road users, and possible alternate routes and modes of travel. Such programs have been found to result in a significant reduction in the number of road users traveling through the temporary traffic zone, which reduces the possible number of conflicts.

**Standard:**

Temporary traffic control plans and devices shall be the responsibility of the authority of a public body or official having jurisdiction for guiding road users. There shall be adequate statutory authority for the implementation and enforcement of needed road user regulations, parking controls, speed zoning, and incident management. Such statutes shall provide sufficient flexibility in the application of temporary traffic control to meet the needs of changing conditions in the temporary traffic control zone.

*Guidance:*

*The temporary traffic control plan should start in the planning phase and continue through the design, construction, and restoration phases. The temporary traffic control plans and devices should follow the principles set forth in this Manual and Part 6 of the MUTCD*

**Option:**

Temporary traffic control plans may deviate from the typical applications described in Typical Applications to allow for conditions and requirements of a particular site or jurisdiction, subject to approval by the Work Zone Safety Branch.

**2.2 RESPONSIBILITY****Standard:**

All persons or agencies authorized to do work within or in close proximity to the vehicular and/or pedestrian right-of-way shall conduct said work to acceptable standards of safety and efficiency and shall be responsible for the following:

- **Obtaining all necessary permits and/or permission to perform work in the vehicular and/or pedestrian right-of-way from the Public Space Management Administration (PSMA), in the Infrastructure Project Management Administration (IPMA) of the District Department of Transportation.**
- **Supplying, installing, maintaining, and removing all traffic controls devices and equipment appropriate for the work area.**
- **Supplying flaggers and other personnel trained in work zone traffic control.**
- **Scheduling and expediting the work to minimize inconvenience to the public.**
- **Calling “Miss Utility” before digging, and notifying the District Department of Transportation 48 hours in advance of starting work.**

- **Informing occupants of abutting properties by written notice of parking prohibitions or access limitations.**
- **Obtaining permission to remove, relocate, cover, or modify existing traffic control and monitoring devices.**
- **Replacing or reimbursing the City for damage to or loss of existing traffic control devices, their supports, and parking meters.**
- **Monitoring traffic control devices for temporary traffic control zones and removing them as soon as they are no longer needed.**

### **2.3 TRAINING**

#### **Standard:**

**Each person whose actions affect maintenance, construction, utility, and incident management – from the upper level management personnel through field personnel – shall receive training in traffic control appropriate to on-the-job decisions each individual is required to make. Only those individuals who are qualified by means of adequate training in safe traffic control practices and have a basic understanding of the principles established by applicable standards and regulations, including those of this Manual and the MUTCD, shall supervise the selection, placement, and maintenance of traffic control devices in work and incident management areas.**

**The contractor or agency shall designate a competent traffic safety officer who shall be thoroughly experienced in and qualified for maintenance of traffic safety control work. Prior to commencing work requiring traffic control management, the contractor or agency shall submit, along with the “Application for Public Space Permit,” the name of the traffic safety officer and any designated substitute. The District Department of Transportation shall have the right to require proof of experience and qualification of designated traffic safety officers. Certification by the American Traffic Safety Services Association (ATSSA) shall be the minimum evidence of training. The traffic safety officer shall be present to supervise the placement and removal of traffic control devices for all phases of work.**

## **2.4 DEFINITIONS OF WORDS AND PHRASES IN THIS MANUAL**

### **Standard:**

**The following select words and phrases have been incorporated from Section 1A.13 of the MUTCD along with some additions for convenience in using this Manual. Additional words, phrases and references exist in Section 1A.13 of the MUTCD and shall be applicable when such definitions are not within this Manual. When used in this Manual, the following words and phrases shall have the following meanings:**

**Advance Notice (24 Hours) (48 Hours):** One or two normal working days in advance as specified. Saturdays, Sundays, and holidays excepted.

**Alley:** Public passageway for vehicles, pedestrians, drainage purposes, or any combination thereof, which connects with a street and which usually affords a means of access to the rear of properties abutting streets or highways.

**Arterial:** Any U.S. or Interstate numbered route, controlled access highway, or other major radial or circumferential highway designated by the Council of the District of Columbia as a part of the arterial system of streets or highways.

**Awning, Canopy, or Covered Walkway:** A temporary roof-like structure over a sidewalk café attached to, supported from, or contiguous to a restaurant. A temporary roof-like structure built to protect pedestrians from overhead work. Covered walkways should be provided where pedestrians are exposed to potential injury from falling objects.

**Bicycle:** A manually powered vehicle consisting of a seat, two wheels, two pedals, and a handle bar.

**Buffer Space:** An optional longitudinal or lateral distance separating vehicles or pedestrians from the work activity.

**Building Line:** The line established by law, beyond which a building should not extend, except as specified by law.

**Central Business District, (CBD):** That area within the following boundaries (including sidewalks): Beginning at 23<sup>rd</sup> Street and Massachusetts Avenue, Northwest, then east along Massachusetts Avenue to Second Street, Northeast, then south on Second Street to D Street, Southeast, then west on D Street in a line crossing Virginia Avenue, Southwest, to 14<sup>th</sup> Street, Southwest, to Constitution Avenue, Northwest, then west on Constitution Avenue to 23<sup>rd</sup> Street, Northwest, then north on 23<sup>rd</sup> Street, Northwest, to Massachusetts Avenue, Northwest.

**Centerline Markings:** The yellow pavement marking line(s) that delineates the separation of traffic lanes that have opposite directions of travel on a roadway. These markings need not be at the geometrical center of the pavement.



**Changeable Message Signs:** Signs that are capable of displaying more than one message, changeable manually, by remote control, or by automatic control. These signs are referred to as Dynamic Message Signs in the National Intelligent Transportation Systems (ITS) Architecture.

**Channelization:** A series of traffic control devices erected to divert traffic around temporary obstructions or to guide traffic through restricted areas.

**Channelizing Line Marking:** A wide or double solid white line used to form islands where traffic in the same direction of travel is permitted on both sides of the island.

**City:** The District of Columbia.

**City Streets:** A public street administered by the City.

**Civilian Crossing Guard:** Any person, other than a police officer, authorized to direct or regulate traffic.

**Clear Zone:** The total roadside border area, starting at the edge of the traveled way, which is wide enough to allow an errant motorist to stop or regain control of a vehicle. This area might consist of a shoulder, a recoverable slope, and/or a non-recoverable, traversable slope with a clear run-out area at its toe.

**Collector Streets:** All streets designated as collector streets on the current District of Columbia Functional Classification of Street Map, the latest copy of which is on file with the Office of Policy and Planning.

**Control of Access Highway:** A highway, street, or roadway with respect to which owners or occupants of abutting property or lands and other persons have no legal right of access to or from same, except at such points only and in such manner as may be determined by the Council of the District of Columbia.

**Crosswalk:** That part of a roadway intersection included within the connections of the lateral lines of the sidewalks on opposite sides of the highway measured from the curbs, or in the absence of curbs, from the edges of the transversable roadway; OR any portion of a roadway at an intersection or elsewhere distinctly indicated for pedestrians crossing by lines or other markings on the surface.

**Daylight Hours (Daytime):** The hours from sunrise to sunset.

**D.C. Building Code:** Title 12 of the District of Columbia Municipal Regulations, "Building Code," as amended.

**D.C. Police Regulations:** The "District of Columbia Police Regulations," as amended.

**D.C. Vehicles and Traffic Code:** DCMR Title 18 of the District of Columbia Municipal Regulations, “Vehicles and Traffic,” as amended.

**D.C. Public Space:** DCMR Title 24 of the District of Columbia Municipal Regulations, “Vehicles and Traffic,” as amended.

**DDOT:** The District Department of Transportation.

**Delineators:** Retro reflective devices mounted on the roadway surface or at the side of the roadway in a series to indicate the alignment of the roadway, especially at night or in adverse weather.

**Department:** The District Department of Transportation.

**Director:** The Director of the Department or the Director’s designee.

**District:** The District of Columbia.

**District Forces:** All employees and/or work crews of the District of Columbia doing work in the right-of-way.

**District Project:** A signed contract with the District Department of Transportation.

**Downtown:** The original commercial area between the Capitol and the White House bounded generally by North Capitol Street on the east, Pennsylvania Avenue, N.W. on the south, 23<sup>rd</sup> Street, N.W. on the west, and Massachusetts Avenue, N.W., on the north.

**Edge Line Markings:** White or yellow pavement marking lines that delineate the right or left edge(s) of a traveled way.

**Engineering Judgment:** The evaluation of available pertinent information and the application of appropriate principles, Standards, Guidance, and practices as contained in this Manual and other sources, for the purpose of deciding upon the applicability, design, operation, or installation of a traffic control device. Engineering judgment shall be exercised by an engineer or by an individual working under the supervision of an engineer, through the application of procedures and criteria established by the engineer. Documentation of engineering judgment is not required.

**Engineering Study:** The comprehensive analysis and evaluation of available pertinent information and the application of appropriate principles, Standards, Guidance, and practices as contained in this Manual and other sources, for the purpose of deciding upon the applicability, design, operation, or installation of a traffic control device. An engineering study shall be performed by an engineer or by an individual working under the supervision of an engineer, through the application of procedures and criteria established by the engineer. An engineering study shall be documented.

**Expressway:** A divided highway with partial access control.

**Flagger:** A qualified (certified) person wearing an orange or yellow-green vest and hard hat using a STOP/SLOW paddle, stationed to assist with traffic control in restricted areas. All flaggers must be certified and have their certification card in their possession when flagging, and they also shall be equipped with electronic devices for communication. The MUTCD in Section 6E.02, High Visibility Safety Apparel, now states, “For daytime and nighttime activity, flaggers shall wear safety apparel meeting the requirements of the ISEA (International Safety Equipment Association) American National Standard for High Visibility Safety Apparel (See Section 1A.12 of the MUTCD) and labeled as meeting ANSI 107–1999 standard performance for class 2 risk exposure.”

**Flagger Control:** Temporary traffic control zone guidance to drivers by a flagger using control signaling devices (such as paddles and flags).

**Flashing (Flashing Mode):** A mode of operation in which a traffic signal indication is turned on and off repetitively.

**Freeway:** A divided and access-controlled road with operating speed of at least 35 mph.

**Guide Sign:** A sign that shows route designations, destinations, directions, distances, services, points of interest, or other geographical, recreational, or cultural information.

**Highway:** The entire width between the boundary lines of every publicly maintained way –in other words, the entire area within the right-of-way, where any part thereof is open to the use of the public for purposes of vehicular or pedestrian travel.

**Hours of Darkness (Night) (Nighttime):** The hours from sunset to sunrise.

**Interstate:** A high-speed divided highway with control of access and designated by the U.S. Department of Transportation.

**Lane Line Markings:** White pavement marking lines that delineate the separation of traffic lanes having the same direction of travel on a roadway.

**Limited Access:** The regulated limitation of public access rights to and from properties abutting a highway facility. Limited access can be either of the following types:

**Full Limited Access** - Provides access to selected public roads and prohibits crossings at grade and direct driveway connections.

**Partial Limited Access** - Provides access to selected public roads, crossings at grade, and some private driveway connections.

**Local Streets:** All streets designated as local on the current District of Columbia Functional Classification of Streets Map, the latest copy of which is on file with the Office of Policy and Planning.

**Major Shopping Center:** A planned large high-volume shopping development with numerous retail establishments.

**Manual:** The D.C. Temporary Traffic Control Manual.

**May:** A permissive condition.

**Median:** The area between two roadways of a divided highway measured from the edge of traveled way to the edge of traveled way. The median excludes turn lanes. The median width might be different between intersections, interchanges, and at opposite approaches of the same intersection.

**Motorized Wheelchair:** A battery operated chair on wheels, designated for, and used primarily by a handicapped person, and which is incapable of speed in excess of eight miles per hour.

**Multiple Lanes:** Two or more through traffic lanes in any one direction.

**MUTCD:** The Manual on Uniform Traffic Control Devices, 2003 Edition, Revision 1 published by the U.S. Department of Transportation.

**Object Markers:** Devices used to mark obstructions within or adjacent to the roadway.

**Off-Peak Traffic Hours:** All hours of the day and days of the week not defined as “peak traffic hours.”

**Peak Traffic Hours:** The hours of 7:00 a.m. to 9:30 a.m. and 4:00 p.m. to 6:30 p.m. Monday through Friday, except holidays.

**Pedestrian:** Any person on foot or who is using a wheelchair, motorized wheelchair, or tricycle.

**Police Department:** The Metropolitan Police Department.

**Principal Arterials:** All streets designated as principal arterials on the current District of Columbia Functional Street Map, the latest copy of which is on file with the Office of Policy and Planning.

**Property Line:** The line or demarcation between privately-owned property fronting or abutting a street and the publicly owned property in such street.

**Public Highway:** A road, street, alley, or highway in the District open to the public as a matter of right for the purposes of vehicular traffic.

**Public Space:** All of the publicly-owned property or right-of-way between the property lines on a street, as such property lines are shown on the Department's records, including, but is not limited to, the roadway, tree spaces, parking spaces, and sidewalks.

**Raised Pavement Marker:** A device with a height of at least 0.4 inches mounted on or in a road surface and intended to supplement pavement markings.

**Regulatory Sign:** A sign that gives notice to road users of traffic laws or regulations.

**Restriction (Street Restriction) (Traffic Restriction):** Any reduction in the normal flow of vehicular or pedestrian traffic in the public right-of-way and/or any reduction of vehicular or pedestrian access to the public right-of-way, including any act or item that causes said reductions.

**Retroreflectivity:** A property of a surface that allows a large portion of the light coming from a point source to be returned directly back to a point near its origin.

**Reversible Lane:** A lane in which the direction of travel is reversed during certain hours in order to increase the capacity in the direction of the heavier traffic demand.

**Right-of-Way (Assignment):** The permitting of vehicles and/or pedestrians to proceed in a lawful manner in preference to other vehicles or pedestrians by the display of sign or signal indications.

**Road User:** A vehicle operator, bicyclist, or pedestrian within the highway, including workers in temporary traffic control zones.

**Rumble Strip:** A series of intermittent, narrow, transverse areas of rough-textured, slightly raised, or depressed road surface that is installed to alert road users to unusual traffic conditions.

**Rural Highway:** A type of roadway normally characterized by lower volumes, higher speeds, fewer turning conflicts, and less conflict with pedestrians.

**Shared Roadway:** A roadway that is officially designated and marked as a bicycle route but which is open to motor vehicle travel and upon which no bicycle lane is designated.

**Shared-Use Path:** A bikeway physically separated from motorized vehicular traffic by an open space or barrier and either within the highway right-of-way or within an independent alignment. Shared-use paths might also be used by pedestrians, skaters, wheelchair users, joggers, and other non-motorized users.

**Sidewalk:** That portion of a street between the curb line, or the lateral line of a roadway, and the adjacent property line or on easements of private property, intended for use by pedestrians.

**Sign:** Any traffic control device that is intended to communicate specific information to road users through a word or symbol legend. Signs do not include traffic control signals, pavement markings, delineators, or channelization devices.

**Sign Assembly:** A group of signs, located on the same support(s), which supplement one another in conveying information to road users.

**Sign Illumination:** Either internal or external lighting that shows similar color by day or night. Street, highway, or strobe lighting shall not be considered as meeting this definition.

**Sign Legend:** All word messages, logos, and symbol designs that are intended to convey specific meanings.

**Sign Panel:** A separate panel or piece of material containing a word or symbol legend that is affixed to the face of a sign.

**Solid Waste Management Administration:** The Sanitation Administration of the District of Columbia Department of Public Works.

**Speed:** Speed is defined based on the following classifications:

**Advisory Speed** - a recommended speed for all vehicles operating on a section of highway and based on the highway design, operating characteristics, and conditions.

**Average Speed** - the summation of the instantaneous or spot-measured speeds at a specific location of vehicles divided by the number of vehicles observed.

**Design Speed** - a selected speed used to determine the various geometric design features of a roadway.

**85th-Percentile Speed** - the speed at or below which 85 percent of the motorized vehicles travel.

**Operating Speed** - a speed at which a typical vehicle or the overall traffic operates. Operating speed may be defined with speed values such as the average, pace, or 85th-percentile speeds.

**Posted Speed** - the speed limit determined by law and shown on Speed Limit signs.

**Statutory Speed** - a speed limit established by legislative action that is typically applicable for highways with specified design, functional, jurisdictional, and/or location characteristic and is not necessarily shown on Speed Limit signs.

**Speed Limit:** The maximum (or minimum) speed applicable to a section of highway as established by law.

**Speed Zone:** A section of highway with a speed limit that is established by law but which may be different from a legislatively specified statutory speed limit.

**Standard Specifications:** The District Department of Transportation Standard Specifications for Highways and Structures (2005) as amended or updated by Supplemental Specifications.

**Stop Line:** A solid white pavement marking line extending across approach lanes to indicate the point at which a stop is intended or required to be made.

**Street:** A public highway as shown on the record of the District, whether designated as a street, alley, avenue, freeway, road, drive, lane, place, boulevard, parkway, circle, or by any other term.

**Temporary Traffic Control Zone:** Highway segment located between the first and last advance warning traffic control devices where road user conditions are changed because of a work zone or incident by the use of temporary traffic control devices, flaggers, police, or other authorized personnel.

**Termination Area:** Area used for returning traffic to the normal path.

**Traffic:** Pedestrians, bicyclists, ridden or herded animals, vehicles, streetcars, and other conveyances either singularly or together while using any highway for purposes of travel.

**Traffic Control Signal (Traffic Signal):** Any device, whether manually, electrically, or mechanically operated, by which traffic is alternately directed to stop and proceed.

**Traffic Control Devices:** Signs, parking meters, traffic signals, barricades, and/or channelizing devices existing and/or temporary as defined and/or illustrated in this Manual and in the Manual on Uniform Traffic Control Devices (MUTCD) used to regulate, warn, or guide traffic, placed on, over, or adjacent to a street, highway, pedestrian facility, or bicycle path by authority of a public agency having jurisdiction.

**Traffic Lane:** Marked pathway, not less than 10 feet wide, for vehicle traffic on streets.

**Traffic Monitoring Equipment Installations:** Devices placed below, on, above, or adjacent to a highway for observing traffic, collecting traffic data, or providing traffic information.

**Traffic Services Administration (TSA):** Administration of the District Department of Transportation responsible for administering traffic operations and safety.

**Traffic Signal Shop:** The Traffic Signal Shop of the DDOT.

**Traffic Space:** Pathway for routing traffic through the temporary traffic control zone.

**Transition Area:** Areas within the temporary traffic control zone where changes in lane-use patterns are implemented.

**Traveled Way:** The portion of the roadway for the movement of vehicles, exclusive of the shoulders, berms, sidewalks, and parking lanes.

**Truck-Mounted Attenuator:** Energy-absorbing devices attached to the rear of trucks to reduce the severity of rear-end crashes.

**TTC:** Temporary Traffic Control.

**Urban Street:** A type of street normally characterized by relatively low speeds, wide ranges of traffic volumes, narrower lanes, frequent intersections and driveways, significant pedestrian traffic, and more businesses and houses.

**Vehicle:** Any device for carrying or conveying persons or objects.

**Warning Sign:** A sign that gives notice to road users of a situation that might not be readily apparent.

**Warrant:** A warrant describes threshold conditions to the engineer in evaluating the potential safety and operational benefits of traffic control devices and is based upon average or normal conditions. Warrants are not a substitute for engineering judgment. The fact that a warrant for a particular traffic control device is met is not conclusive justification for the installation of the device.

**Weekdays:** The days of the week starting at 5:00 a.m. on Monday and ending at 10:00 p.m. on Friday, except holidays.

**Weekends:** The days of the week starting at 10:00 p.m. on Friday and ending at 5:00 a.m. on Monday.

**Wheelchair:** A chair on wheels, designated for, and used primarily by, a handicapped person.

**Work Area:** The work space or public space set aside for workers, equipment, and material storage.



**Work Zone:** An area of a highway and public space affected by construction, maintenance, or utility work activities. This includes the area necessary for placing traffic control devices.

**Wrong-Way Arrows:** Slender, elongated, white pavement marking arrows placed upstream from the ramp terminus to indicate the correct direction of traffic flow. Wrong-way arrows are intended primarily to warn wrong-way road users that they are going in the wrong direction.

**2.5 MINIMUM STANDARDS**

**Standard:**

**The standards presented in this manual are the minimum required. Additional signs, cones, barricades, and warning devices may be used, but, at no time will less than what is specified herein be acceptable. Since public safety is involved, a high degree of conformity to the presented standards is necessary. This Manual is intended to supplement the MUTCD, which remains the national standard. The MUTCD should be examined for treatments which are excluded from this Manual.**

**2.6 SPECIAL EVENTS, HOLIDAYS, INAUGURATIONS**

Support:

Holidays - The following days are recognized as legal holidays:

- |                                   |                  |
|-----------------------------------|------------------|
| New Year's Day                    | Independence Day |
| Martin Luther King Jr.'s Birthday | Columbus Day     |
| President's Day                   | Veteran's Day    |
| Memorial Day                      | Thanksgiving Day |
| Labor Day                         | Christmas Day    |

Any day declared a holiday by the District shall be observed. When a holiday falls on a Sunday, the following Monday will be observed as a holiday. When a holiday falls on a Saturday, the preceding Friday will be observed.

**2.7 ABBREVIATIONS USED ON TRAFFIC CONTROL DEVICES**

**Standard:**

**When the word messages shown in Table 2-1 need to be abbreviated in connection with traffic control devices, the abbreviations shown in Table 2-1 shall be used.**

*Guidance:*

*The abbreviations for the words listed in Table 2-2 should not be used in connection with traffic control devices unless the prompt word shown in Table 2-2 either precedes or follows the abbreviation.*

**Standard:**

**The abbreviations shown in Table 2-3 shall not be used in connection with traffic control devices because of their potential to be misinterpreted by road users.**

*Guidance:*

*Where multiple abbreviations are permitted in Tables 2-1 or 2-2, the same abbreviation should be used throughout a Ward or single work zone area.*

**Table 2-1. Acceptable Abbreviations**

<b>Word Message</b>	<b>Standard Abbreviation</b>	<b>Word Message</b>	<b>Standard Abbreviation</b>
Afternoon / Evening	PM	Meter(s)	M
Alternate	ALT	Metric Ton	t
Avenue	AVE	Mile(s)	MI
Bicycle	BIKE	Miles Per Hour	MPH or M.P.H.
Boulevard	BLVD	Minute(s)	MIN
Cannot	CANT	Monday	MON
CB Radio	CB	Morning / Late Night	AM
Center	CNTR	Normal	NORM
Civil Defense	CD	North	N
Compressed Natural Gas	CNG	Northbound	NB
Crossing (other than highway-rail)	XING	Parking	PKING
Diesel Fuel	D	Parkway	PKWY
Do Not	DON'T	Pavement Marking	PVMT MKING
Drive	DR	Pedestrian	PED
East	E	Pounds	LBS
Eastbound	EB	Right	RHT
Electric Vehicle	EV	Road	RD
Emergency	EMER	Saturday	SAT
Enter	Enter	Service	SERV
Entrance	Entrance	Shoulder	SHLDR
Expressway	EXPWY	Slippery	SLIP
FM Radio	FM	South	S
Freeway	FRWY, FWY	Speed	SPD
Friday	FRI	Street	ST
Hazardous Cargo	HC	Sunday	SUN
Hazardous Material	HAZMAT	Telephone	PHONE
High Occupancy Vehicle	HOV	Temporary	TEMP
Highway	HWY	Thursday	THURS
Highway-Rail Grade Crossing	RXR	Tires With Lugs	LUGS
Hospital	H	Tons of Weight	T
Hour(s)	HR	Traffic	TRAF
Information	INFO	Travelers	TRAVLRS
It Is	ITS	Tuesday	TUES
Junction / Intersection	JCT	Two-Way Intersection	2-WAY
Kilogram	kg	Two-Wheeled Vehicles	CYCLES
Kilometer(s)	KM	US Numbered Route	US
Kilometers Per Hour	km/h	Vehicles	VEH
Lane	LN	Warning	WARN
Left	LFT	Wednesday	WED
Liquid Propane Gas	LP-GAS	West	W
		Westbound	WB
		Will Not	WONT

Table 2-2. Abbreviations That Are Acceptable Only with a Prompt Word

Word	Abbreviation	Prompt Word
Access	ACCS	Road
Ahead	AHD	Fog*
Blocked	BLKD	Lane*
Bridge	BRDG	[Name]*
Condition	COND	Traffic*
Congested	CONG	Traffic*
Construction	CONST	Ahead
Downtown	DWNTN	Traffic*
Eastbound	E-BND	Traffic
Exit	EX, EXT	Next*
Express	EXP	Lane
Frontage	FRNTG	Road
Hazardous	HAZ	Driving
Interstate	I	[Number]
Local	LOC	Traffic
Lower	LWR	Level
Major	MAJ	Accident
Minor	MNR	Accident
Northbound	N-BND	Traffic
Oversized	OVRSZ	Load
Prepare	PREP	To Stop
Pavement	PVMT	Wet*
Quality	QLTY	Air*
Roadwork	RDWK	Ahead [Distance]
Route	RT	Best*
Southbound	S-BND	Traffic
Township	TWNSHP	Limits
Turnpike	TRNPK	[Name]*
Upper	UPR	Level
Vehicle	VEH	Stalled*
Westbound	W-BND	Traffic

\* These prompt words should precede the abbreviation

**Table 2-3. Unacceptable Abbreviations**

<b>Abbreviation</b>	<b>Intended Word</b>	<b>Common Misinterpretations</b>
ACC	Accident	Access Road
CLRS	Clears	Colors
DLY	Delay	Daily
FDR	Feeder	Federal
L	Left	LANE (Merge)
LT	Light (Traffic)	Left
PARK	Parking	Park
POLL	Pollution (Index)	Poll
RED	Reduce	Red
STAD	Stadium	Standard
WRNG	Warning	Wrong



## **SECTION 3 - FUNDAMENTAL PRINCIPLES OF TEMPORARY TRAFFIC CONTROL**

### **3.1 FUNDAMENTAL PRINCIPLES**

**Standard:**

**The control of road users (motorists, bicyclists, and pedestrians) through a temporary traffic control zone shall be an essential part of highway construction, utility work, maintenance operations, and the management of traffic incidents.**

**Support:**

Construction, maintenance, utility, and incident zones can all benefit from temporary traffic control to compensate for the unexpected or unusual situations faced by road users. When planning for temporary traffic control in these zones, it can be assumed that it is appropriate for road users to exercise caution. Even though road users are assumed to be using caution, special care is still needed in applying temporary traffic control techniques.

Special plans preparation and coordination with transit, other highway agencies, police and other emergency units, utilities, schools, and railroad companies might be needed to reduce unexpected and unusual road user operation situations.

During temporary traffic control activities, commercial vehicles might need to follow a different route from passenger vehicles because of bridge, weight, clearance, or geometric restrictions. Also, vehicles carrying hazardous materials might need to follow a different route from other vehicles.

Experience has shown that following the fundamental principles of this manual will assist road users and help protect workers in the vicinity of temporary traffic control zones. While these principles provide guidance for good temporary traffic control for the practitioner, they do not establish standards and warrants.

*Guidance:*

*The needs of pedestrians who have disabilities should be considered in accordance with the Americans with Disabilities Act of 1990 (ADA), Title II, Paragraph 35.130. For further information, see the new accessibility guidelines for buildings and facilities, transportation facilities, and transportation vehicles, September 1994.*

*Road user and worker safety in temporary traffic control zones should be an integral and high-priority element of every project from planning through design and construction. Similarly, maintenance and utility work should be planned and conducted with the safety of motorists, bicyclists, pedestrians (including those with disabilities), and workers being considered at all times.*

*If the temporary traffic control zone includes a highway-rail grade crossing, early coordination with the railroad company should take place.*

**Support:**

Formulating specific plans for temporary traffic control at traffic incidents is difficult because of the variety of situations that can arise.

**Guidance:**

*General plans or guidelines should be developed to provide safety for motorists, bicyclists, pedestrians, workers, enforcement/emergency officials, and equipment, with the following factors being considered:*

- 1. The basic safety principles governing the design of permanent roadways and roadsides should also govern the design of temporary traffic control zones. The goal should be to route road users through such zones using roadway geometrics, roadside features, and temporary traffic control devices. These devices should be as close as possible to those for normal highway situations.*
- 2. A temporary traffic control plan, in detail appropriate to the complexity of the work project or incident, should be prepared and understood by all responsible parties before the site is occupied. Any changes in the temporary traffic control plan should be approved by an official knowledgeable (for example, trained and/or certified) in proper temporary traffic control practices and documented.*

*Road user movement should be inhibited as little as practical, based on the following considerations:*

- 1. Temporary traffic control at work and incident sites should be designed on the assumption that motorists will only reduce their speeds if they clearly perceive a need to do so (see information on speed control).*
- 2. Frequent and abrupt changes in geometrics such as lane narrowing, dropped lanes, or main roadway transitions that require rapid maneuvers should be avoided.*
- 3. Provisions should be made for the reasonably safe operation of work, particularly on high-speed, high-volume roadways.*
- 4. Road users should be encouraged to use alternative routes that do not include temporary traffic control zones.*
- 5. Bicyclists and pedestrians, including those with disabilities, should be provided with access and reasonably safe passage through the temporary traffic control zone.*



6. *Roadway occupancy by Contractors and Government entities should be scheduled during off-peak hours and, if necessary, night work should be considered.*
7. *Early coordination with officials having jurisdiction over the affected cross streets and providing emergency services should occur before roadway or ramp closings.*

*Motorists, bicyclists, and pedestrians should be guided in a clear and positive manner while approaching and traversing temporary traffic control zones and incident sites. The following principles should be applied:*

1. *Adequate warning, delineation, and channelization should be provided to assist in guiding road users in advance of and through the temporary traffic control zone or incident site by using proper pavement marking, signing, or other devices that are effective under varying conditions. Providing information that is in usable formats by pedestrians with visual disabilities should also be considered.*
2. *Temporary traffic control devices inconsistent with intended travel paths through temporary traffic control zones should be removed or covered. However, in short duration and mobile operations, where visible permanent devices are inconsistent with intended travel paths, devices that highlight or emphasize the appropriate path should be used.*
3. *Flagging procedures, when used, should provide positive guidance to road users traversing the temporary traffic control zone.*

*To provide acceptable levels of operation, routine day and night inspections of temporary traffic control elements should be performed.*

**Standard:**

**Temporary traffic control installations shall be reviewed daily to ensure the functionality of the temporary traffic control devices and compliance to this Manual. These reviews shall be documented on a weekly basis including detailed information as warranted for the type of operation, using the “Daily Checklist for Temporary Traffic Control” form found at the front of this document.**

*Guidance:*

*Review of temporary traffic control on high speed, high traffic volume projects should also be performed during night and non-work periods (weekends), as well on all projects after severe weather conditions.*

**Standard:**

**A review of temporary traffic control shall be performed for compliance immediately after a change in traffic patterns. Deficiencies in temporary traffic**

control shall be corrected and documented as soon as possible. The review and documentation of temporary traffic control installation shall be by someone trained and knowledgeable about the fundamental principles of temporary traffic control and related work activities being performed. The individual responsible for temporary traffic control review shall have the authority to halt work until applicable or remedial safety measures are taken.

Support:

Other methods of documentation include written notes, project diary entries, photographs, and video recordings.

*Guidance:*

*When warranted, an engineering study should be made (in cooperation with law enforcement officials) of reported crashes occurring within the temporary traffic control zone. Crash records in temporary traffic control zones should be monitored to identify the need for changes in the temporary traffic control zone.*

**Standard:**

**All temporary traffic control devices shall be removed as soon as practical when they are no longer needed. When work is suspended for short periods, advance warning signs that are no longer appropriate shall be removed from the roadway, and other inappropriate devices shall be removed from the work area so they are not visible to motorists.**

*Guidance:*

*Attention should be given to the maintenance of roadside safety during the life of the temporary traffic control zone by applying the following principles:*

- 1. To accommodate run-off-the-road incidents, disabled vehicles, or emergency situations, unencumbered roadside recovery areas or clear zones should be provided where practical.*
- 2. Channelization of road users (motorists, bicyclists, and pedestrians) should be accomplished by the use of pavement markings, signing, and crashworthy, detectable channelizing devices.*
- 3. Work equipment, workers' private vehicles, materials, and debris should be stored in such a manner to reduce the probability of being impacted by run-off-the-road vehicles.*

*Each person whose actions affect temporary traffic control zone safety, from the upper-level management through the field workers, should receive training appropriate to the job decisions each individual is required to make.*

**Standard:**

**Only those individuals who are trained in proper temporary traffic control practices and have a basic understanding of the principles (established by applicable standards and guidelines, including those of this Manual) shall supervise the selection, placement, and maintenance of temporary traffic control devices used for temporary traffic control zones and for incident management.**

*Guidance:*

*Good public relations should be maintained by applying the following principles:*

- 1. The need of all road users (motorists, bicyclists, and pedestrians) should be assessed such that appropriate advance notice is given and clearly defined alternate paths are provided.*
- 2. The cooperation of the various news media should be sought in publicizing the existence of and reasons for temporary traffic control zones because news releases can assist in keeping the road users well-informed.*
- 3. The needs of abutting property owners, residents, and businesses should be assessed and appropriate accommodations made.*
- 4. The needs of emergency service providers (police, fire, and medical) should be assessed and appropriate coordination and accommodations made.*
- 5. The needs of railroads and transit should be assessed and appropriate coordination and accommodations made.*
- 6. The needs of commercial vehicles such as buses and large trucks should be assessed and appropriate accommodations made.*



## **SECTION 4 - TEMPORARY TRAFFIC CONTROL ELEMENTS**

### **4.1 TEMPORARY TRAFFIC CONTROL PLANS**

**Standard:**

**With the exception of issuance of a blanket permit, which is acceptable for one year, Temporary Traffic Control Plans (TTCP) shall be effective for a period of no longer than six months after approval by DDOT. All work in excess of six months shall require re-submittal of TTCP.**

**When applying for a blanket permit, an electronic spreadsheet shall be sent weekly to TSA and Public Space Management Administration (PSMA) prior to work commencing.**

**Support:**

A Temporary Traffic Control Plan describes temporary traffic control measures to be used for facilitating road users through a work zone. Temporary traffic control plans play a vital role in providing continuity of safe and efficient road user flow when a work zone, incident, or other event temporarily disrupts normal road user flow. Important auxiliary provisions that cannot conveniently be specified on project plans can easily be incorporated into Special Provisions within the temporary traffic control plan.

Temporary traffic control plans range in scope from being very detailed to simply referencing typical drawings contained in this Manual, standard approved highway agency drawings and manuals, or specific drawings contained in the contract documents. The degree of detail in the temporary traffic control plan depends entirely on the nature and complexity of the situation.

*Guidance:*

*Temporary traffic control plans should be prepared by persons knowledgeable (for example, trained and/or certified) about the fundamental principles of temporary traffic control and work activities to be performed. The design, selection, and placement of temporary traffic control devices for a temporary traffic control plan should be based on engineering judgment.*

*Coordination should be made between adjacent or overlapping projects to check that duplicate signing is not used and to check compatibility of traffic control between adjacent or overlapping projects.*

*Traffic control planning should be completed for all highway construction, utility work, maintenance operations, and incident management including minor maintenance and utility projects prior to occupying the temporary traffic control zone. Planning for all road users should be included in the process.*

Option:

Provisions may be incorporated into the project bid documents that enable contractors to develop an alternate temporary traffic control plan.

Modifications of temporary traffic control plans may be necessary because of changed conditions or a determination of better methods of safely and efficiently handling road users.

**Standard:**

**This alternate or modified plan shall be reviewed and approved by a trained and knowledgeable authority in temporary traffic control practices prior to implementation.**

*Guidance:*

*Provisions for effective continuity of transit service should be incorporated into the temporary traffic control planning process because often public transit buses cannot efficiently be detoured in the same manner as other vehicles (particularly for short-term maintenance projects). Where applicable, the temporary traffic control plan should provide for features such as temporary bus stops, pull-outs, and satisfactory waiting areas for transit patrons, if applicable (see Section 10A.05 of the MUTCD for additional light rail transit issues to consider for temporary traffic control).*

*Provisions for effective continuity of railroad and/or METRO service, as well as acceptable access to abutting property owners and businesses, should also be incorporated into the temporary traffic control planning process.*

*Reduced speed zoning should be avoided as much as practical. Reduced speed limits should be used only in the specific portion of the temporary traffic control zone where conditions or restrictive features are present. However, frequent changes in the speed limit should be avoided.*

*A temporary traffic control plan should be designed so that vehicles can safely travel through the temporary traffic control zone with a speed limit reduction of no more than 10 mph.*

**Standard:**

**Speeds shall only be reduced within construction/maintenance work zones by the DDOT Engineer upon completion of an engineering and traffic investigation warranting the reduction. Documentation of the change shall be performed.**

*Guidance:*

*A reduction of more than 10 mph in the speed limit should be used only when required by restrictive features in the temporary traffic control zone. Where restrictive features justify a speed reduction of more than 10 mph, additional motorist notification should be provided. The speed limit should be stepped down in advance of the location requiring the lowest speed, and additional temporary traffic control warning devices should be used. Regulatory speed signs shall be used within the Work Zone such that the District of Columbia Metropolitan Police Department can enforce the reduced speed limit. Reduced speed zoning (lowering the regulatory speed limit) should be avoided as much as practical because motorists will reduce their speeds only if they clearly perceive a need to do so.*

**Support:**

Research has demonstrated that large reductions in the speed limit, such as a 25 mph reduction, on high-speed roadways increase speed variance and the potential for crashes. Smaller reductions in the speed limit of up to 10 mph cause smaller changes in speed variance and lessen the potential for increased crashes. A reduction in the regulatory speed limit of only up to 10 mph from the normal speed limit has been shown to be more effective.

**4.2 TEMPORARY TRAFFIC CONTROL ZONES****Support:**

A temporary traffic control zone is an area of a highway where road user conditions are changed because of a work zone or an incident through the use of temporary traffic control devices, police, or other authorized personnel.

A work zone is an area of a highway with construction, maintenance, or utility work activities. A work zone is typically marked by signs, channelizing devices, barriers, pavement markings, and/or work vehicles. It extends from the first warning sign or rotating/strobe lights on a vehicle to the END ROAD WORK sign or the last temporary traffic control device.

An incident area is an area of a highway where temporary traffic controls are imposed by authorized officials in response to a traffic incident, natural disaster, or special event. It extends from the first warning sign or rotating/strobe lights on a vehicle to the last temporary traffic control device or to a point where road users return to the original lane alignment and are clear of the incident.

### **4.3 COMPONENTS OF TEMPORARY TRAFFIC CONTROL ZONES**

Support:

Most temporary traffic control zones are divided into five areas: the advance warning area, the transition area, the buffer space area, the activity area, and the termination area. Figure 4-1 illustrates these five areas. These five areas are described in the sections that follow.

#### **4.3.1 ADVANCE WARNING AREA**

Support:

The advance warning area is the section of highway where road users are informed about the upcoming work zone or incident area.

Option:

The advance warning area may vary from a single sign or rotating/strobe lights on a vehicle to a series of signs in advance of the temporary traffic control zone activity area.

*Guidance:*

*Typical distances for placement of advance warning signs on expressways and freeways should be longer because motorists are conditioned to uninterrupted flow. Therefore the advance warning sign placement should extend on these facilities as far as one mile or more.*

Option:

Low speed urban streets with speeds of 25 mph or less may reduce the spacing to +/-150' between signs.



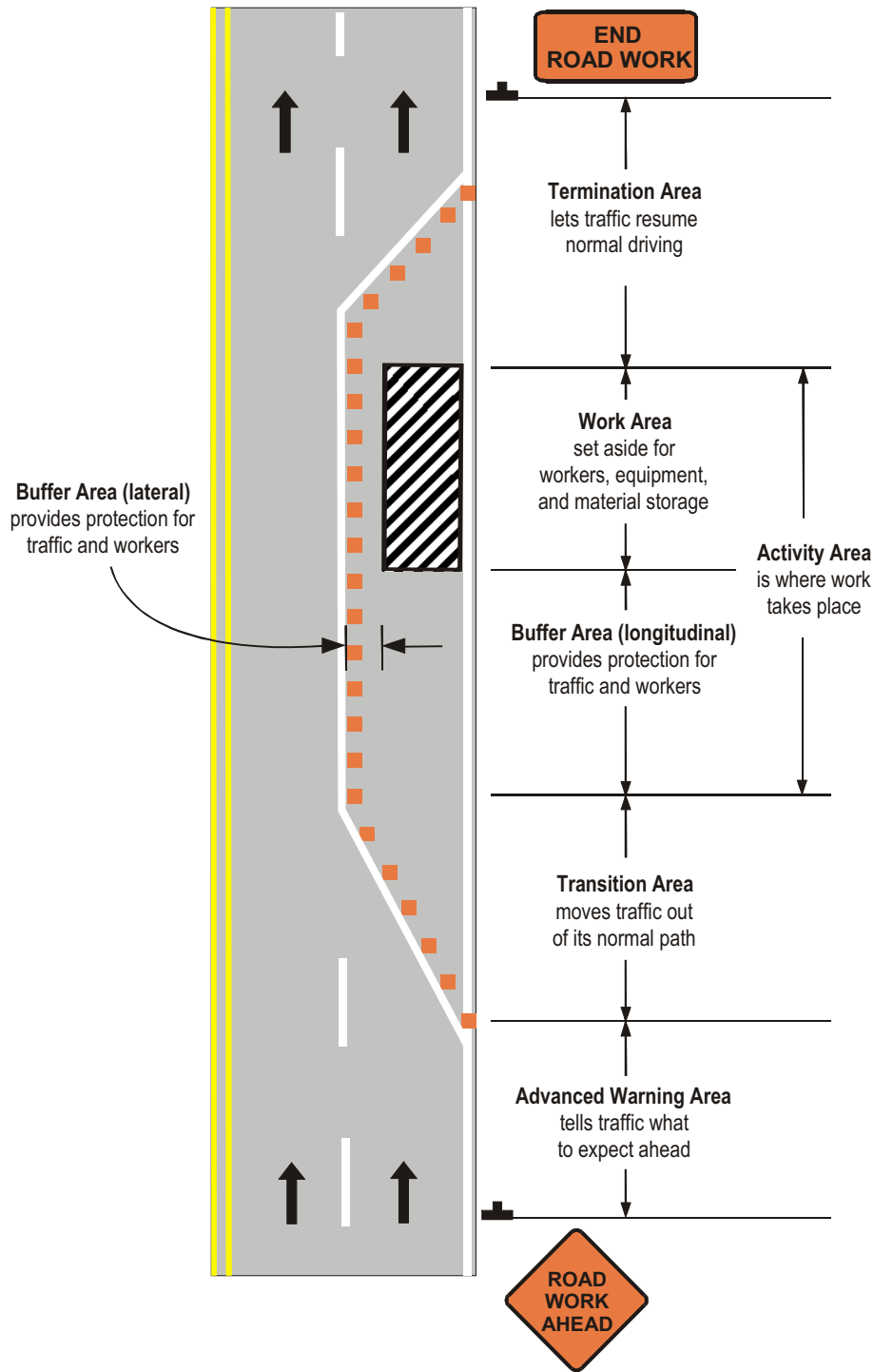

Figure 4-1. Five Parts of Temporary Traffic Control Zone

**4.3.2 TRANSITION AREA**

Support:

The transition area is that section of highway where road users are redirected out of their normal path.

**Standard:**

**When redirection of the road users' normal path is required, they shall be channelized from the normal path to a new path.**

Support:

In mobile operations, the transition area moves with the work space. Transition areas usually involve strategic use of tapers, which because of their importance, are discussed separately in detail.

**4.3.3 BUFFER SPACE AREA**

Support:

The buffer space is a lateral and/or longitudinal area that separates road user flow from the work space or an unsafe area and might provide some recovery space for an errant vehicle. The traffic space is the portion of the highway in which road users are routed through the activity area.

**Standard:**

**Neither work activity nor storage of equipment, vehicles, or material shall occur within a buffer space.**

Option:

Buffer spaces may be positioned either longitudinally or laterally with respect to the direction of road user flow. The activity area may contain one or more lateral or longitudinal buffer spaces.

*Guidance:*

*A longitudinal buffer space should be placed in advance of a work space. The longitudinal buffer space may also be used to separate opposing road user flows that use portions of the same traffic lane. Buffer space applications are shown on Figure 4-2.*

*The length of a longitudinal buffer space should be as shown in Table 4-1, and is based on the posted speed limit of the temporary traffic control zone.*

Table 4-1. Length of Longitudinal Buffer Space

Speed (mph)	Distance (ft)
20	35
25	55
30	85
35	120
40	170
45	220
50	280
55	335
60	415
65	485

**Support:**

Typically, the buffer space is formed as a traffic island and defined by channelizing devices. When a shadow vehicle is placed in advance of the work space, only the space upstream of the vehicle constitutes the buffer space.

**Option:**

The lateral buffer space may be used to separate the traffic space from the work space, as shown in Figures 4-1 and 4-2, or such areas as excavations or pavement-edge drop-offs. A lateral buffer space also may be used between two travel lanes, especially those carrying opposing flows.

**Guidance:**

*The width of a lateral buffer space should be determined by engineering judgment.*

Option:

When work occurs on a high-volume, highly congested facility, a vehicle storage or staging space may be provided for incident response and emergency vehicles (for example, tow trucks and fire apparatus) so that these vehicles can respond quickly to road user incidents.

*Guidance:*

*If used, an incident response and emergency-vehicle storage area should not extend into any portion of the buffer space.*

**4.3.4 ACTIVITY AREA**

Support:

The activity area is the section of the highway where the work activity takes place.

The work space is that portion of the highway closed to road users and set aside for workers, equipment, and material and a shadow vehicle if one is used upstream. Work spaces are usually delineated for road users by channelizing devices or, to exclude vehicles and pedestrians, by temporary barriers.

Option:

The work space may be stationary or may move as work progresses.

*Guidance:*

*Since there may be several work spaces (some even separated by several miles) within the project limits, each work space should be adequately signed to inform road users and reduce confusion.*

*The maximum length of the work space should not exceed two miles unless approved by the DDOT Engineer.*

Support:

The traffic space is the portion of the highway in which road users are routed through the activity area.

#### **4.3.5 TERMINATION AREA**

**Standard:**

**The termination area shall be used to return road users to their normal path. The termination area shall extend from the downstream end of the work area to the END ROAD WORK signs.**

**An END ROAD WORK sign, a Speed Limit sign, or other signs shall be used to inform road users that they can resume normal operations.**

*Guidance:*

*Conditions may exist where posting the END ROAD WORK signs may not be helpful. For example, the END ROAD WORK signs should normally not be used if other temporary traffic control zones begin within a quarter-mile of the temporary traffic control within the urban core.*

#### **4.4 TAPERS**

*Guidance:*

*Tapers should be used in both the transition and termination areas.*

Option:

Whenever tapers are to be used in close proximity to an interchange ramp, crossroads, curves, or other influencing factors, the length of the tapers may be adjusted, subject to approval of DDOT.

**Support:**

Tapers are created by using a series of channelizing devices and/or pavement markings to move traffic out of or into the normal path. Types of tapers are shown in Figure 4-2.

Longer tapers are not necessarily better than shorter tapers (particularly in the urban core characterized by short block lengths and driveways) because extended tapers tend to encourage sluggish operation and to encourage motorists to delay lane changes unnecessarily. The test concerning adequate lengths of tapers involves observation of motorist performance after temporary traffic control plans are put into effect.

*Guidance:*

*The criteria for determining the taper length (L) are shown in Table 4-2 and should be the minimum used.*

The maximum distance in feet between devices in a taper should not exceed 20 feet at speeds up to 35 mph and 40 feet for speeds greater than 35 mph.

**Table 4-2. Taper Length Criteria for Temporary Traffic Control Zones**

Taper Lengths (L)					
Speed Limit (mph)	Width of offset (ft)				Remarks (Formula)
	9	10	11	12	
25	95	105	115	125	$L = (S^2W)/60$
30	135	150	165	180	$L = (S^2W)/60$
35	185	205	225	245	$L = (S^2W)/60$
40	240	270	295	320	$L = (S^2W)/60$
45	405	450	495	540	$L = W \times S$
50	450	500	550	600	$L = W \times S$
55	495	550	605	660	$L = W \times S$

Note:  $L$  = Length of Taper (ft),  $W$  = Width of Lane or Taper (ft), and  $S$  = Speed (mph)

Support:

A merging taper requires the longest distance because motorists are required to merge into common road space.

Guidance:

A merging taper should be long enough to enable merging motorists to have adequate advance warning and sufficient length to adjust their speeds and merge into a single lane before the end of the transition.

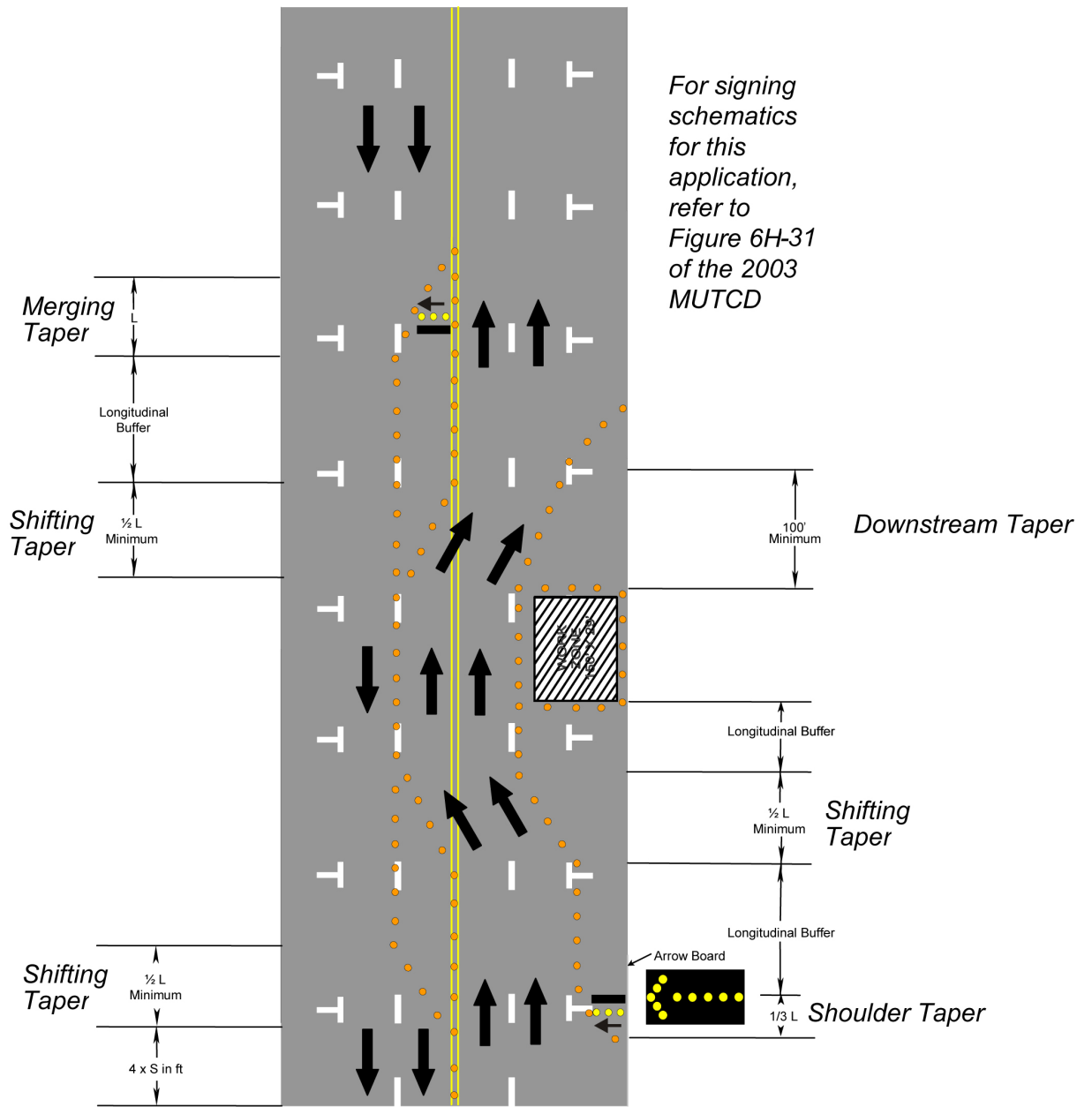

Figure 4-2. Types of Tapers and Buffer Spaces

Support:

A shifting taper is used when a lateral shift is needed. When more space is available, a longer than minimum taper distance can be beneficial. Changes in alignment can also be accomplished by using horizontal curves designed for normal highway speeds.

*Guidance:*

*A shifting taper should have a minimum length of at least one-half L (Table 4-3).*

Support:

A shoulder taper will be beneficial on a high-speed roadway where shoulders are part of the activity area and are closed or when improved shoulders might be mistaken as a driving lane. In these instances, the same, but abbreviated, closure procedures used on a normal portion of the roadway can be used.

*Guidance:*

*Shoulder tapers, where applicable, should have a length of approximately one-third L (see Table 4-3). If a shoulder is used as a travel lane, either through practice or during a temporary traffic control activity, a normal merging or shifting taper should be used. A downstream taper should be used in termination areas to provide a visual cue to the motorist that access is available back into the original lane or path that was closed.*

**Table 4-3. Types of Tapers for Temporary Traffic Control Zones**

Type of Taper		
Merging Taper	Number of Lanes is reduced	L minimum
Shifting Taper	Lateral shift, no lane reduction	$\frac{1}{2}$ L minimum
Shoulder Taper	Shoulder closed	$\frac{1}{3}$ L minimum
Two-way Traffic Taper	Opposing directions	50 feet min 100 feet max
Downstream Taper	End of work area	100 feet/lane max



*When used, a downstream taper should have a minimum length of approximately 100 feet per lane with devices placed at a spacing of approximately 20 feet.*

Support:

The one-lane, two-way taper is used in advance of an activity area that occupies part of a two-way roadway in such a way that a portion of the road is used alternately by traffic in each direction.

Guidance:

*In a one-lane, two-way operation, traffic should be controlled by a flagger or lane control temporary signals. A short taper having a maximum length of 100 feet with channelizing devices at approximately 20-foot spacing should be used to guide traffic into the one-way section.*

#### **4.5 DETOURS AND DIVERSIONS**

Support:

A detour is a temporary rerouting of road users onto an existing highway in order to avoid a temporary traffic control zone.

Guidance:

*Detours should be clearly signed over their entire length so that road users can easily use existing highways to return to the original highway.*

Support:

A diversion is a temporary rerouting of road users onto a temporary highway or alignment placed around the work area.

#### **4.6 ONE-LANE, TWO-WAY TRAFFIC CONTROL**

**Standard:**

**When traffic in both directions must use a single lane for a limited distance, movements from each end shall be coordinated.**

Guidance:

*Provisions should be made for alternate one-way movement through the constricted section via methods such as flagger control, a flag transfer, a pilot car, or traffic control signals.*

*Control points at each end should be chosen to permit easy passing of opposing lanes of vehicles. If traffic on the affected one-lane roadway is not visible from one end to the other, then flagging procedures, a pilot car, or traffic control signal should be used to control opposing traffic flows.*

Support:

At a spot constriction, such as an isolated pavement patch on highways with lower speeds and adequate sight distance, the movement of traffic through one-lane, two-way constrictions tends to be self-regulating.

#### **4.6.1 FLAGGER METHOD OF ONE-LANE, TWO-WAY TRAFFIC CONTROL**

Option:

When a one-lane, two-way temporary traffic control zone is short enough to allow a flagger to see from one end of the zone to the other, traffic may be controlled by either a single flagger or by a flagger at each end of the section.

*Guidance:*

*When a single flagger is used, the flagger should be stationed on the shoulder opposite the constriction or work space or in a position where good visibility and traffic control can be maintained at all times. When good visibility and traffic control cannot be maintained by one flagger station, traffic should be controlled by a flagger at each end of the section. One of the flaggers should be designated as the coordinator.*

*Flaggers should be able to communicate with each other electronically (preferred), orally, or with manual signals. These manual signals should not be mistaken for flagging signals.*

#### **4.6.2 PILOT CAR METHOD OF ONE-LANE, TWO-WAY TRAFFIC CONTROL**

Option:

A pilot car may be used to guide a queue of vehicles through the temporary traffic control zone or detour.

*Guidance:*

*The operation of the pilot vehicle should be coordinated with flagging operations or other controls at each end of the one-lane section. The pilot car should have the name of the contractor or contracting authority prominently displayed.*

**Standard:**

**The PILOT CAR FOLLOW ME (G20-4) sign shall be mounted at a conspicuous location on the rear of the vehicle.**

**4.6.3 TEMPORARY TRAFFIC CONTROL SIGNAL METHOD OF ONE-LANE, TWO-WAY TRAFFIC CONTROL**

Option:

Traffic control signals may be used to control motor vehicle traffic movements in one-lane, two-way temporary traffic control zones on a case-by-case basis, as approved by Traffic Services Administration (DDOT) (see Chapter 4G of the MUCTD).



**SECTION 5 - PEDESTRIAN AND WORKER SAFETY**

**Standard:**

The various temporary traffic control provisions for pedestrian and worker safety set forth in this Manual and the MUTCD shall be applied by knowledgeable (for example, trained and/or certified) persons after appropriate evaluation and engineering judgment. Advance notification of sidewalk closures shall be required and is subject to approval by DDOT prior to implementation.

**5.1 PEDESTRIAN CONSIDERATIONS**

**Standard:**

When pedestrian pathways are closed or disrupted due to construction, maintenance, or utility work, pedestrian traffic controls are required. These controls shall include signs, channelizing devices, flags, etc. to clearly direct pedestrians through or around the work site.

Advanced notification of sidewalk closures shall be provided.

Adequate provisions shall be made for persons with disabilities.

Access to businesses, residences, and crosswalks must be maintained. Adverse economic consequences to businesses within the work zone area should be avoided by maintaining proper access.

*Guidance:*

*Some major considerations in planning for pedestrian safety in work zones include:*

- A. Pedestrians should not be led into conflicts with work site vehicles, equipment, and operations.*
- B. Pedestrians should not be led into conflicts with work site vehicles moving through or around the work site.*
- C. Pedestrians should be provided with a safe, convenient path that replicates as nearly as practical the most desirable characteristics of the existing sidewalk(s).*
- D. Covered walkways should be provided when pedestrians are exposed to potential injury from falling objects.*

**Support:**

It must be recognized that pedestrians are reluctant to retrace their steps to a prior intersection for a crossing or to add distance or out-of-the-way travel to a destination.

**Guidance:**

*Adequate provisions should be made for persons with disabilities as determined by an engineering study. There are three considerations in planning for pedestrians in temporary traffic control zones:*

- A. Pedestrians should not be led into conflicts with work site vehicles, equipment, and operations.*
- B. Pedestrians should not be led into conflicts with vehicles moving through or around the work site.*
- C. Pedestrians should be provided with a safe, convenient path that replicates as nearly as practical the most desirable characteristics of the existing sidewalk(s) or a footpath(s).*

*A pedestrian route should not be severed and/or moved for non-construction activities such as parking for vehicles and equipment. Consideration should be made to separate pedestrian movements from both work site activity and motor vehicle traffic. Pedestrians should be appropriately directed with advance signing that encourages them to cross to the opposite side of the roadway. In urban and suburban areas with high motor vehicle traffic volumes, these signs should be placed at intersections so that pedestrians are not confronted with midblock work sites that will induce them to attempt skirting the work site or making a midblock crossing.*

*Figures 5-1 and 5-2 show typical temporary traffic control device usage and techniques for pedestrian movement through work zones.*

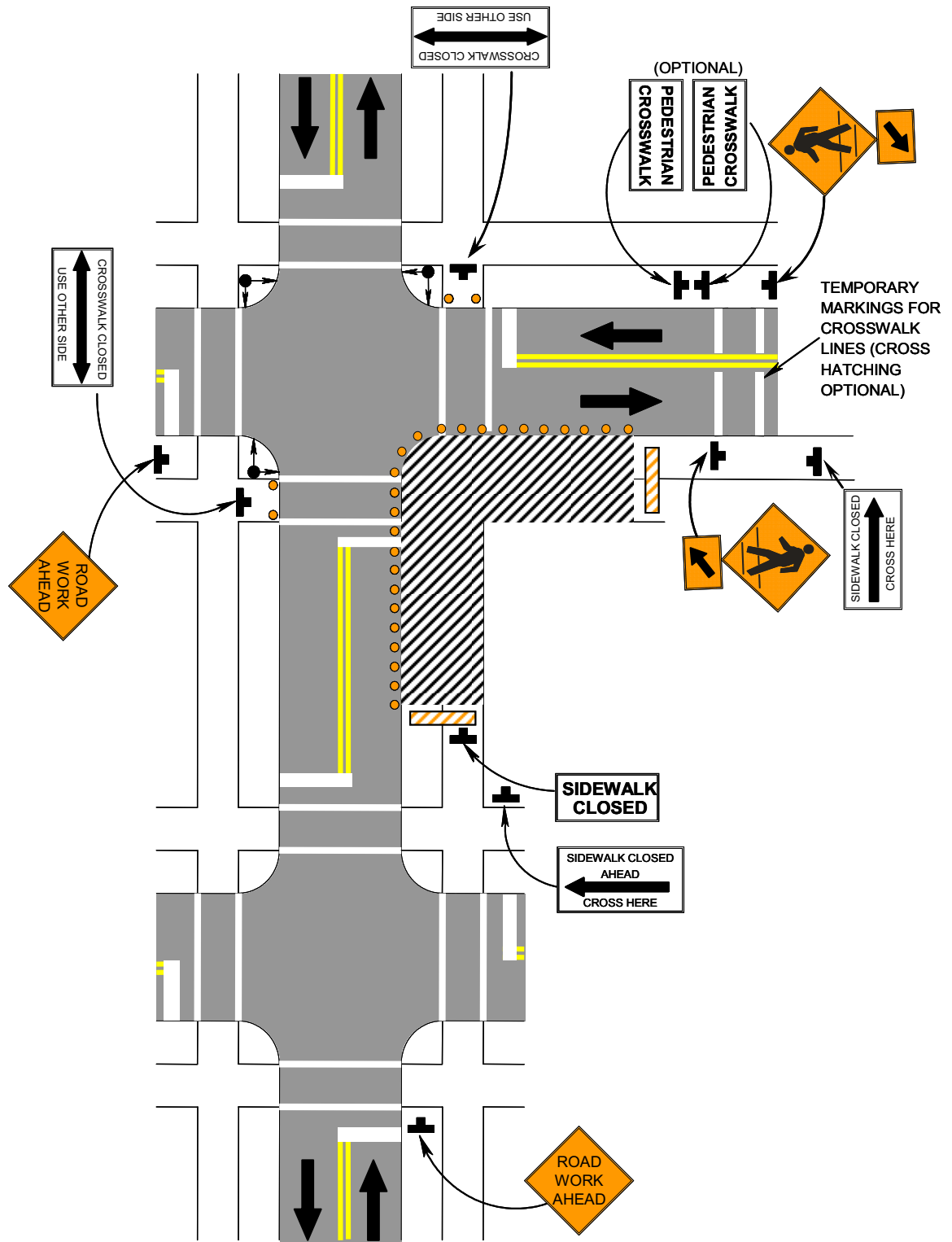

Figure 5-1. Crosswalk Closure and Pedestrian Detour

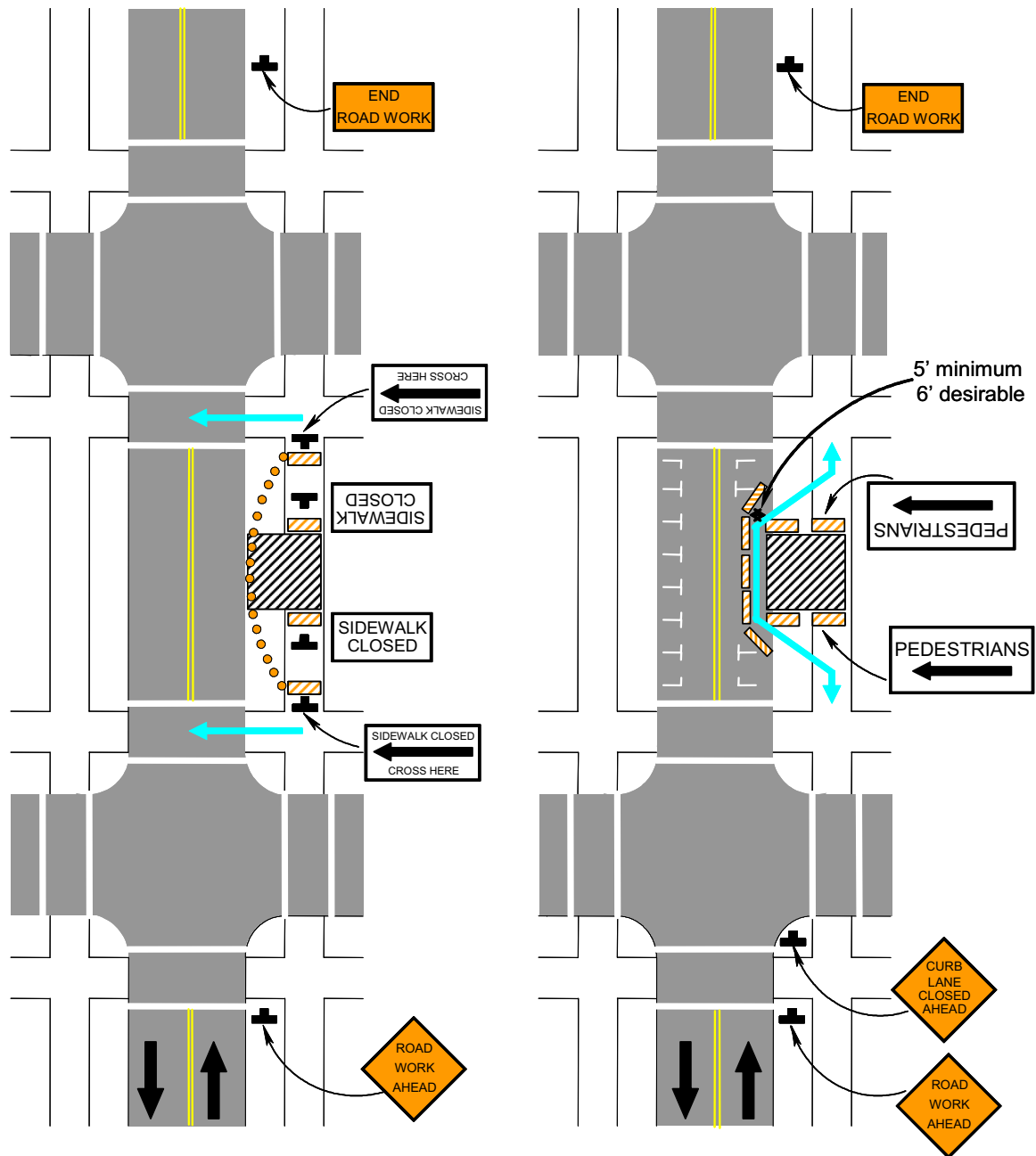

Figure 5-2. Sidewalk Closure and Bypass Sidewalk Operation



**Standard:**

The following items must be considered when creating a Traffic Control Plan (TCP):

- A. Impact on pedestrian generators (Schools, Senior Centers, transit stops, etc.).**
- B. Impact on existing pedestrian flow.**
- C. Pedestrian information needs – advance, transition, work area, and exit information.**
- D. Pedestrian Facilities – walkway width, surface, boundaries, transitions, and channelization.**
- E. Intersections – crosswalk placement, additional signing/markings, and traffic signals modification (timing, pedestrian signals, push button, etc.).**
- F. Adequate pedestrian protection – physical separation from work space and vehicular traffic, overhead protection, etc.**
- G. Construction staging to maintain pedestrian access throughout all construction phases.**
- H. Temporary nighttime lighting.**
- I. Requirements of the Americans with Disabilities Act (ADA) of 1990.**
- J. Location/access to business, residences, etc.**
- K. Future Considerations – frequent checks of the pedestrian accommodations during construction to ensure that the temporary Traffic Control Plan (TCP) is followed, traffic control devices are maintained in good condition, and a safe, accessible pedestrian route is available at all times.**

**Guidance:**

*When pedestrian movement through or around a work site is necessary, a separate usable footpath without abrupt changes in grade or terrain should be provided.*

**Option:**

Whenever it is feasible, closing off the work site from pedestrian intrusion may be preferable to channelizing pedestrian traffic along the site with temporary traffic control devices such as barricades and drums or other suitable fencing.

*Guidance:*

*Fencing should not create sight distance restrictions for road users. Fences should not be constructed of materials that would be hazardous if impacted by vehicles. Wooden railing, fencing, and similar systems placed immediately adjacent to motor vehicle traffic should not be used as substitutes for crashworthy temporary traffic barriers.*

**Standard:**

**Temporary traffic control devices used to delineate a temporary traffic control zone pedestrian walkway shall be crashworthy and, when struck by vehicles, present a minimum threat to pedestrians, workers, and occupants of impacting vehicles.**

*Guidance:*

*Ballast for temporary traffic control devices should be kept to the minimum amount needed and should be mounted low to prevent penetration of the vehicle windshield.*

*Movement by work vehicles and equipment across designated pedestrian paths should be minimized and, when necessary, should be controlled by flaggers or temporary traffic control. Staging or stopping of work vehicles or equipment along the side of pedestrian paths should be avoided, since it encourages movement of workers, equipment, and materials across the pedestrian path. Access to work space across pedestrian walkways should be minimized because the access often creates unacceptable changes in grade and rough or muddy terrain, and pedestrians will tend to avoid these areas by attempting non-intersection crossings.*

**Standard:**

**A temporary covered walkway must be used to protect pedestrians from falling debris and to provide a covered passage for pedestrians. (See Figures 5-3 and 5-4.) Temporary covered walkways are subject to the following criteria:**

- A. The structural design and construction of covered pedestrian pathways shall be approved by DDOT.**
- B. Covered walkways shall be sturdily constructed and adequately lighted for nighttime use with vandal-resistant fixtures mounted on 30-foot centers near the roof line.**
- C. Under no circumstance shall work equipment or any other objects associated with work zone operations be placed on top of the roof of the covered walkway, unless approved by DDOT.**

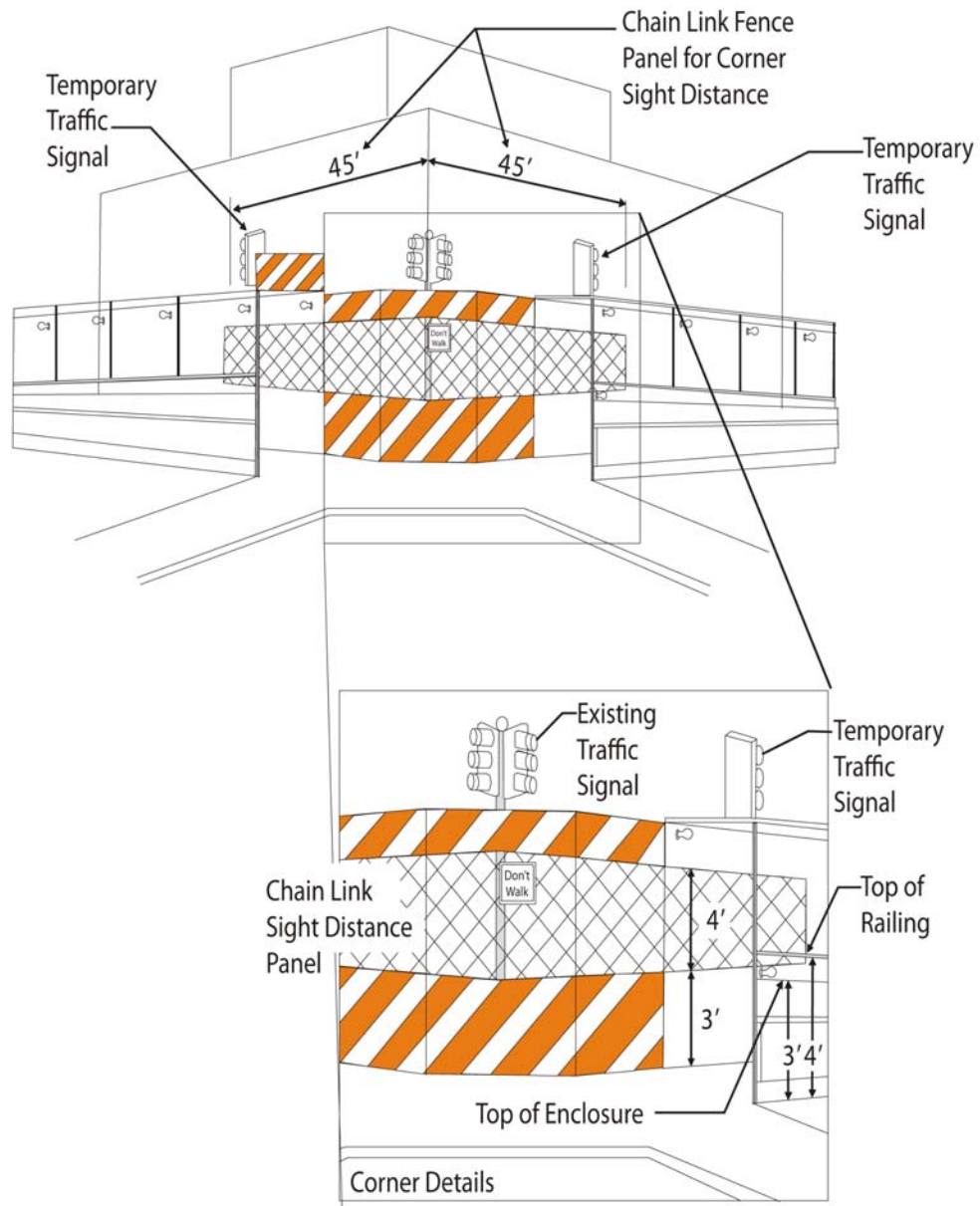

Figure 5-3. Temporary Covered Walkway with Fencing at Intersection Corner

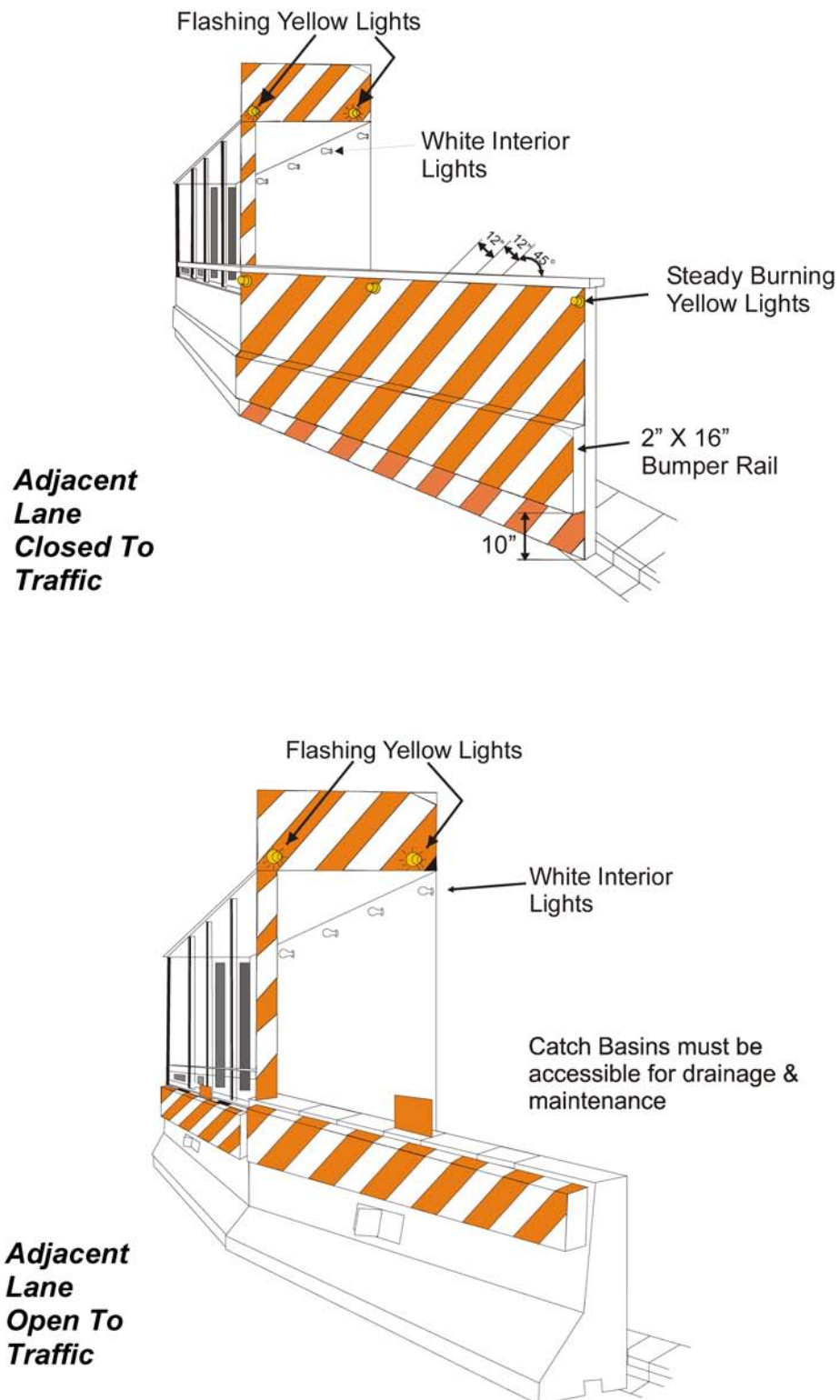

Figure 5-4. Temporary Covered Walkway at Mid-Block

- D. Small trailers can be placed on top of the covered walkway provided the covered walkway can support the weight.**
- E. Minimum requirements for the floor and roof shall be 300 pounds per square foot. The walking surface shall be paved or covered with plywood or wood planking.**
- F. The overhead clearance shall be at least eight feet high. Temporary covered ways shall afford free passage of at least six feet in width along the sidewalk.**
- G. Continuous handrails shall be installed along the walls of the covered walkway to aid pedestrians with usual and ambulatory difficulties.**
- H. Adequate provisions shall be made for persons with disabilities, including wheelchair ramps.**
- I. Covered pedestrian pathways shall be provided with corner treatments which allow a minimum 45-foot sight distance triangle.**

**Standard:**

**When a temporary traffic barrier is used to shield pedestrians, it must be designed to suit site conditions. It must also be configured to allow for adequate drainage from the adjacent roadway. Catch basins must be accessible for proper drainage and maintenance.**

**Support:**

Depending on the possible motor vehicle speed and angle of impact, temporary traffic barriers might deflect upon impact by an errant vehicle.

**Standard:**

**Short intermittent segments of temporary traffic barrier shall not be used because they nullify the containment and redirective capabilities of the temporary traffic barrier, increase the potential for serious injury both to vehicle occupants and pedestrians, and encourage the presence of blunt, leading ends. All upstream leading ends that are present shall be appropriately flared or protected with properly installed and maintained crashworthy cushions. Adjacent temporary traffic barrier segments shall be properly connected in order to provide the overall strength required for the temporary traffic barrier to perform properly.**

**Normal vertical curbing shall not be used as a substitute for temporary traffic barriers when temporary traffic barriers are clearly needed.**

**Option:**

Temporary traffic barriers or longitudinal channelizing devices may be used to discourage pedestrians from unauthorized movements into the work space. They may

also be used to inhibit conflicts with motor vehicle traffic by minimizing the possibility of midblock crossings.

Support:

A major concern for pedestrians is urban and suburban building construction encroaching onto the contiguous sidewalks, which forces pedestrians off the curb into direct conflict with moving vehicles.

*Guidance:*

*If a high potential exists for vehicle incursions into the pedestrian path, pedestrians should be rerouted or temporary traffic barriers should be installed.*

Support:

Standard temporary traffic control devices can satisfactorily delineate a pedestrian path. Although tape, rope, fencing, or plastic chain strung between devices can help discourage pedestrian movements off the designated pathway, they cannot eliminate them entirely.

*Guidance:*

*The extent of pedestrian needs should be determined through engineering judgment for each work zone situation. The contractor in charge of the temporary traffic control should regularly inspect the activity area so that effective pedestrian temporary traffic control is maintained.*

## **5.2 WORKER CONSIDERATIONS**

Support:

Equally as important as the safety of road users traveling through the temporary traffic control zone is the safety of workers. Temporary traffic control zones present temporary and constantly-changing conditions that are unexpected by the road user. This creates an even higher degree of vulnerability for workers on or near the roadway. Maintaining temporary traffic control zones with road user flow inhibited as little as possible and using temporary traffic control devices that get the road user's attention and provide positive direction are of particular importance.

*Guidance:*

*The following are the key elements of temporary traffic control management that should be considered to improve worker safety:*

- A. *Training - All workers should be trained on how to work next to motor vehicle traffic in a way that minimizes their vulnerability. Workers having specific temporary traffic control responsibilities should be trained in temporary traffic control techniques, device usage, and placement. Training should be conducted on a continual basis.*
- B. *Worker Clothing - All workers should be adequately clothed for the type of operations they will be performing (See standard below for clothing requirement when working near traffic).*
- C. *Temporary Traffic Barriers - Temporary traffic barriers should be placed along the work space based on an engineering study considering factors such as lateral clearance of workers from adjacent traffic, speed of traffic, duration and type of operations, time of day, and volume of traffic.*
- D. *Speed Reduction - Reducing the speed of motor vehicle traffic, mainly through regulatory speed zoning, funneling, use of law enforcement officials, lane reduction, or flaggers should be considered.*
- E. *Activity Area – Planning the internal work activity area to minimize backing-up maneuvers of construction vehicles should be considered to minimize the inherent risk to workers on foot.*

**Standard:**

**After January 1, 2007, workers shall wear safety apparel meeting the requirements of ISEA “American National Standard for High-Visibility Apparel” (see MUTCD Section 1A.11 “Relation to Other Publications”) and labeled as meeting the ANSI/ISEA 107-2004 standard performance for Class 3 risk exposure. The apparel background (outer) material shall be either fluorescent orange-red or fluorescent yellow-green as defined in the standard. The retroreflective material shall either be orange, yellow, white, silver, yellow-green, or a fluorescent version of these colors, and shall be visible at a minimum distance of 1,000 feet. The retroreflective clothing shall be designed to clearly identify the wearer as a person.**

*Guidance:*

*Until January 1, 2007, all workers should wear an orange, yellow, or yellow-green (or fluorescent versions of these colors) shirt, vest, or jacket for daytime work visible at a minimum distance of 1,000 feet.*

**Standard:**

**For nighttime work outside garments similar to daytime garments shall be worn and shall be retroreflective. The retroreflective material shall be orange, yellow, white, silver, yellow-green, or a fluorescent version of one of these colors and shall be visible at a minimum distance of 1,000 feet. The retroreflective clothing shall be designed to clearly identify the wearer as a person.**

Option:

The following are additional elements of temporary traffic control management that may be considered to improve worker safety:

1. Road Closure - If alternate routes are available to handle road users, the road may be closed temporarily. This may also facilitate project completion and thus further reduce worker vulnerability.
2. Police Use - In highly vulnerable work situations, particularly those of relatively short duration, police units may be stationed to heighten the awareness of passing vehicular traffic and to improve safety through the temporary traffic control zone.
3. Lighting - For nighttime work, the temporary traffic control zone and approaches may be lighted.
4. Special Devices - These include rumble strips, portable changeable message signs, hazard identification beacons, flags, and warning lights. Intrusion warning devices may be used to alert workers to the approach of errant vehicles.

Support:

Judicious use of the special devices described in Item 4 above might be helpful for certain difficult temporary traffic control situations, but misuse or overuse of special devices or techniques might lessen their effectiveness.



## **SECTION 6 - FLAGGER CONTROL**

### **6.1 QUALIFICATIONS FOR FLAGGERS**

**Standard:**

**A flagger shall be a person who provides temporary traffic control. A flagger shall be certified in flagging and shall have his/her certification card with them at all times while performing flagging activities.**

*Guidance:*

*Because flaggers are responsible for public safety and make the greatest number of contacts with the public of all highway workers, they should be trained in safe traffic control practices and public contact techniques. Flaggers should have the following minimum qualifications, skills, and abilities:*

- A. Sense of responsibility for the safety of the public and the workers*
- B. Adequate training in safe temporary traffic control practices*
- C. Average intelligence*
- D. Good physical condition, including sight, mobility, and hearing*
- E. Mental alertness and the ability to react in an emergency*
- F. Courteous but firm manner*
- G. Skill in communicating specific instructions clearly, firmly, and courteously*
- H. At least 18 years old*

### **6.2 HIGH-VISIBILITY CLOTHING**

**Standard:**

**The flagger shall remain fully clothed, from neck to feet, when flagging. This includes the wearing of shirts with sleeves (at least short sleeves in length), long pants, OSHA approved hardhats, and steel toe safety shoes. Prior to July 1, 2007, for daytime work, the flagger's vest and/or jacket shall be orange, yellow, yellow-green, or a fluorescent version of these colors. The vest or jacket must be approved by DDOT. For nighttime work, similar outside garments shall be retroreflective. The retroreflective material shall be orange, yellow, white, silver, yellow-green, or a fluorescent version of these colors, and shall be visible at a minimum distance of 1,000 feet. The retroreflective clothing shall be designed to clearly identify the wearer as a person.**

After January 1, 2007, flaggers shall wear safety apparel meeting the requirements of ISEA “American National Standard for High-Visibility Apparel” and labeled as meeting the ANSI/ISEA 107-2004 standard performance for Class 3 risk exposure. The apparel background (outer) material shall be either fluorescent orange-red or fluorescent yellow-green as defined in the standard. The retroreflective material shall be orange, yellow, white, silver, yellow-green, or a fluorescent version of these colors, and shall be visible at a minimum distance of 1,000 feet. The retroreflective clothing shall be designed to clearly identify the wearer as a person.

*Guidance:*

*The flagger should be properly attired such that they are not distracting to motorists (no provocative clothing or clothing with words or phrases unrelated to work zone operation).*

*When uniformed law enforcement officers are used, high-visibility clothing as described above should be worn by the law enforcement officer.*

### **6.3 HAND-SIGNALING DEVICES**

**Support:**

Hand-signaling devices, such as STOP/SLOW paddles, lights, and red flags, are used to control road users through temporary traffic control zones.

**Standard:**

**The STOP/SLOW paddle shall be the primary hand-signaling device because the STOP/SLOW paddle gives road users more positive guidance than red flags.**

*Guidance:*

*Use of red flags should be limited to emergency situations and use by traffic spotters.*

**Standard:**

**The STOP/SLOW paddle shall be approved by DDOT. It shall have an octagonal shape on a rigid handle, shall be at least 24 inches wide with letters at least eight inches high, and should be fabricated from light, semi-rigid material. It shall be mounted on a 7-foot round pole. The background of the STOP face shall be red with white letters and border and made of encapsulated lens sheeting material. The background of the SLOW face shall be fluorescent orange prismatic lens sheeting material with black letters and border.**

Option:

The STOP/SLOW paddle may be modified to improve conspicuity by incorporating white flashing lights. The white flashing lights may be arranged in any of the following patterns:

- A. Two white lights centered vertically above and below the STOP and/or SLOW legend
- B. Two white lights centered horizontally on each side of the STOP and/or SLOW legend
- C. One white light centered below the STOP and/or SLOW legend
- D. A series of eight or more small white lights no larger than 1/4 inch in diameter along the outer edge of the paddle, arranged in an octagonal pattern at the eight corners of the border of the STOP side of the paddle and/or arranged in a diamond pattern along the border of the SLOW side of the panel. More than eight lights may be used only if the arrangement of the lights is such that it clearly conveys the octagonal shape of the STOP side of the paddle and/or the diamond shape of the SLOW side of the paddle

**Standard:**

**If flashing lights are used on the STOP/SLOW paddle, the flash rate shall be at least 50, but not more than 60, flashes per minute. Flags, when used for emergency situations and by traffic spotters, shall be a minimum of 24 inches square, made of a good grade of red material, and securely fastened to a staff that is approximately 36 inches in length. When used at nighttime, flags shall be retroreflectorized red.**

Option:

For surveying and other operations occurring on the road edge or near the centerline of two-lane roadways, a combination STOP/SLOW paddle and SLOW/SLOW paddle utilizing a double-sided SLOW flip panel may be used to prevent unnecessary stopping of vehicles by the flagger.

**6.4 FLAGGER PROCEDURES**

**Support:**

The use of paddles and flags by flaggers is illustrated in Figure 6-1.

**Preferred Method**

**Emergency Situations Only**

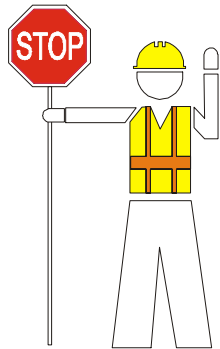

*To Stop Traffic*

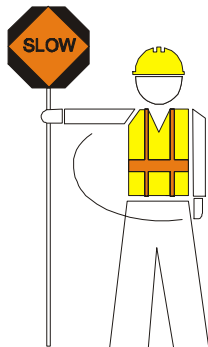
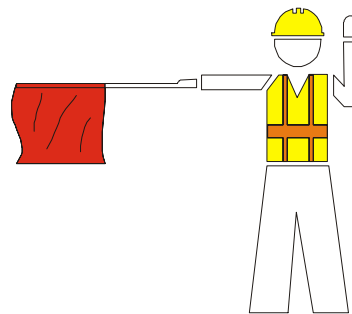

*To Let Traffic Proceed*

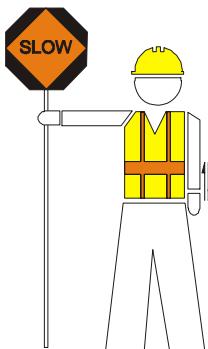
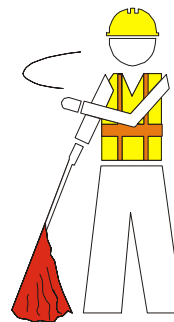

*To Alert & Slow Traffic*

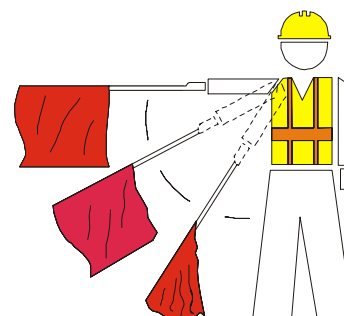

**Figure 6-1. Use of Hand Signaling Devices by Flagger**

**Standard:**

The following methods of signaling with paddles shall be used:

- A. To stop road users, the flagger shall face road users and aim the STOP paddle face toward road users in a stationary position with the arm extended horizontally away from the body. The free arm shall be held with the palm of the hand above shoulder level toward approaching traffic.
- B. To direct stopped road users to proceed, the flagger shall face road users and aim the SLOW paddle face toward road users in a stationary position with the arm extended horizontally away from the body. The flagger shall motion with the free hand for road users to proceed.
- C. To alert or slow traffic, the flagger shall face road users with the SLOW paddle face aimed toward road users in a stationary position with the arm extended horizontally away from the body. For added emphasis, the flagger may raise and lower the free hand with the palm down.

**Option:**

To further alert or slow traffic, the flagger holding the SLOW paddle face toward road users may motion up and down with the free hand, palm down.

**Standard:**

The following methods of signaling with a flag shall be used:

- A. To stop road users, the flagger shall face road users and extend the flag staff horizontally across the road users' lane in a stationary position so that the full area of the flag is visibly hanging below the staff. The free arm shall be held with the palm of the hand above the shoulder level toward approaching traffic.
- B. To direct stopped road users to proceed, the flagger shall stand parallel to the road user movement with flag and arm lowered from the view of the road users and shall motion with the free hand for road users to proceed. Flags shall not be used to signal road users to proceed.
- C. The flagger shall face traffic with the flag held in the down position and slowly motion up and down with the free hand, palm down, indicating the vehicle should slow down.

## 6.5 FLAGGER STATIONS

### Standard:

Flagger stations shall be located far enough in advance of the work space so that approaching road users will have sufficient distance to stop before entering the work space. Flagger stations shall be located such there is high visibility for on-coming traffic.

### Support:

Guidelines for determining the distance of the flagger station in advance of the work space are shown in Table 6-1.

**Table 6-1. Distance of Flagger Station in Advance of the Work Space**

Speed (mph)*	Distance (ft)
20	35
25	55
30	85
35	120
40	170
45	220
50	280
55	335
60	415
65	485

\* Posted speed of the temporary traffic control zone

### Option:

The distances shown in Table 6-1 may be increased for downgrades and other conditions that affect stopping distance.

### Guidance:

*To assure that a fully alert flagger is present at the flagger station, flaggers should be relieved every two hours for a minimum period of 15 minutes.*

**Standard:**

**Flagger stations shall be preceded by proper advance warning signs to allow adequate reaction distance for motorists. At night, flagger stations shall be illuminated.**

*Guidance:*

*The flagger should stand either on the curb or shoulder adjacent to the road user being controlled or in the closed lane prior to stopping road users. A flagger should only stand in the lane being used by moving road users AFTER road users have stopped. The flagger should be clearly visible to the first approaching road user at all times. The flagger also should be visible to other road users. The flagger should be stationed sufficiently in advance of the workers to warn them (for example, with audible warning devices such as horns, whistles, etc.) of approaching danger by out-of-control vehicles.*

**Standard:**

**The flagger shall stand alone, never permitting a group of workers to congregate around the flagger station. Vehicles and equipment shall not be allowed around the flagger station, which can interfere with the visibility of the flagger to approaching motorists.**

**When the flagger is no longer at the flagger station performing flagging duties, the advance warning signs advising of flagging operations shall be removed.**

Option:

If work and/or equipment is still in the area, the ROAD WORK AHEAD sign may remain.

At a spot constriction, the flagger may have to take a position on the curb or shoulder opposite the closed section in order to operate effectively.

At spot lane closures where adequate sight distance and a low traffic volume is available for the safe handling of traffic, the use of one flagger may be sufficient.

**Standard:**

**All flagger stations shall be in communication with each other via electronic communication equipment (2-way radios, cell-phones with direct connection, etc.).**

## **6.6 TRAFFIC SPOTTERS**

### **Support:**

A traffic spotter's primary function is to alert and assist motorists through temporary traffic control zones in emergency situations only.

### **Standard:**

**Qualifications, clothing requirements, and hand signaling procedures for traffic spotters shall be the same as for flaggers. Hand signaling devices for traffic spotters shall be a red flag a minimum of 24 inches square fastened to a staff that is approximately 36 inches in length.**

### *Guidance:*

*The location of the traffic spotter should be where he is visible and capable of directing traffic from both directions.*

### **Standard:**

**The ROAD WORK AHEAD sign shall be the minimum sign requirement for traffic spotters.**

### Option:

Additional signing and other traffic control devices may be required, depending on the type and visibility of the operation, subject to the discretion of DDOT.



## **SECTION 7 - TEMPORARY TRAFFIC CONTROL ZONE DEVICES**

### **7.1 TYPES OF DEVICES**

**Standard:**

**Traffic control devices shall be defined as all signs, signals, markings, and other devices used to regulate, warn, or guide traffic, placed on, over, or adjacent to a street, highway, pedestrian facility, or bikeway by authority of a public body or official having jurisdiction.**

**All traffic control devices used on street and highway construction, maintenance, utility, or incident management operations shall conform to the applicable provisions of this Manual.**

*Guidance:*

*The design and application of temporary traffic control devices used in temporary traffic control zones should consider the needs of all road users (motorists, pedestrians, and bicyclists).*

**Support:**

Crashworthiness and crash testing information on devices described in Part 6 of the MUTCD are found in the AASHTO *Roadside Design Guide*.<sup>iii</sup> (See MUTCD Section 1A.11 “Relation to Other Publications”).

### **7.2 GENERAL CHARACTERISTICS OF SIGNS**

**Support:**

Temporary traffic control zone signs convey both general and specific messages by means of words or symbols and have the same three categories as all road user signs: regulatory, warning, and guide.

**Standard:**

**The colors for regulatory signs shall follow the standards for regulatory signs in Table 2A-4 and Chapter 2B of the MUTCD. Warning signs in temporary traffic control zones shall have a black legend on a fluorescent orange background, except for the Railroad Advance Warning (W10-1) sign, which shall have a black message and border on a yellow background. Colors for guide signs shall follow the Standards in Table 2A-4 and Chapter 2D, except for guide signs as noted in Section 6F.47 of the MUTCD. Sign material shall conform to the latest District Road and Bridge Specification including all revisions to such.**

Option:

Existing warning signs that are still applicable may remain in place.

In order to maintain the systematic use of yellow or fluorescent yellow-green background for pedestrian, bicycle, and school warning signs in a jurisdiction, the yellow or fluorescent yellow-green background for pedestrian, bicycle, and school warning signs may be used in temporary traffic control zones.

Standard orange flags or flashing warning lights for post-mounted signs may be used in conjunction with signs.

**Standard:**

**When standard orange 24 x 24 inches flags or flashing warning lights are used in conjunction with post mounted signs, they shall not block the sign face.**

Option:

The dimensions of signs shown in this Manual are for standard sizes, which may be increased wherever necessary for greater legibility or emphasis.

**Standard:**

**Deviations from standard sizes as prescribed herein shall be in 6-inch increments.**

Support:

Sign design details are contained in the MUTCD.

**Standard:**

**All signs used at night shall be either retroreflective with a material that has a smooth, sealed outer surface or illuminated to show the same shape and similar color both day and night.**

Option:

Sign illumination may be either internal or external.

Support:

Street, highway, or strobe lighting does not constitute external sign illumination.

Option:

Signs may be made of rigid or flexible material.

### **7.3 SIGN PLACEMENT**

*Guidance:*

*Signs should be located on the right side of the roadway unless otherwise specified in this Manual.*

**Standard:**

**On roadways having a median wider than eight feet, left and right sign assemblies shall be used.**

Option:

Crashworthy signs may be mounted on or above Type III barricades.

Support:

Guidelines for height and lateral clearance of temporary post-mounted signs are shown in Figure 7-1.

**Standard:**

**Post-mounted signs installed at the side of the road in residential and urban areas shall be mounted at a height at least seven feet, measured from the bottom of the sign to the near edge of the pavement. For crashworthy purposes, the top of the sign shall be a minimum of nine feet above the ground elevation at the base of the sign. The height to the bottom of a secondary sign mounted below another sign may be one foot less than the 7-foot requirement. Signs mounted on barricades and barricade/sign combinations shall be crashworthy.**

**For sign posts which are not fixed in the ground, but instead mounted on horizontal support platforms, sand bags shall be used for ballast to prevent overturning.**

*Guidance:*

*Neither portable nor permanent sign supports should be located on sidewalks, bicycle lanes, or areas designated for pedestrian or bicycle traffic. Signs mounted lower than seven feet should not project more than four inches into pedestrian facilities.*

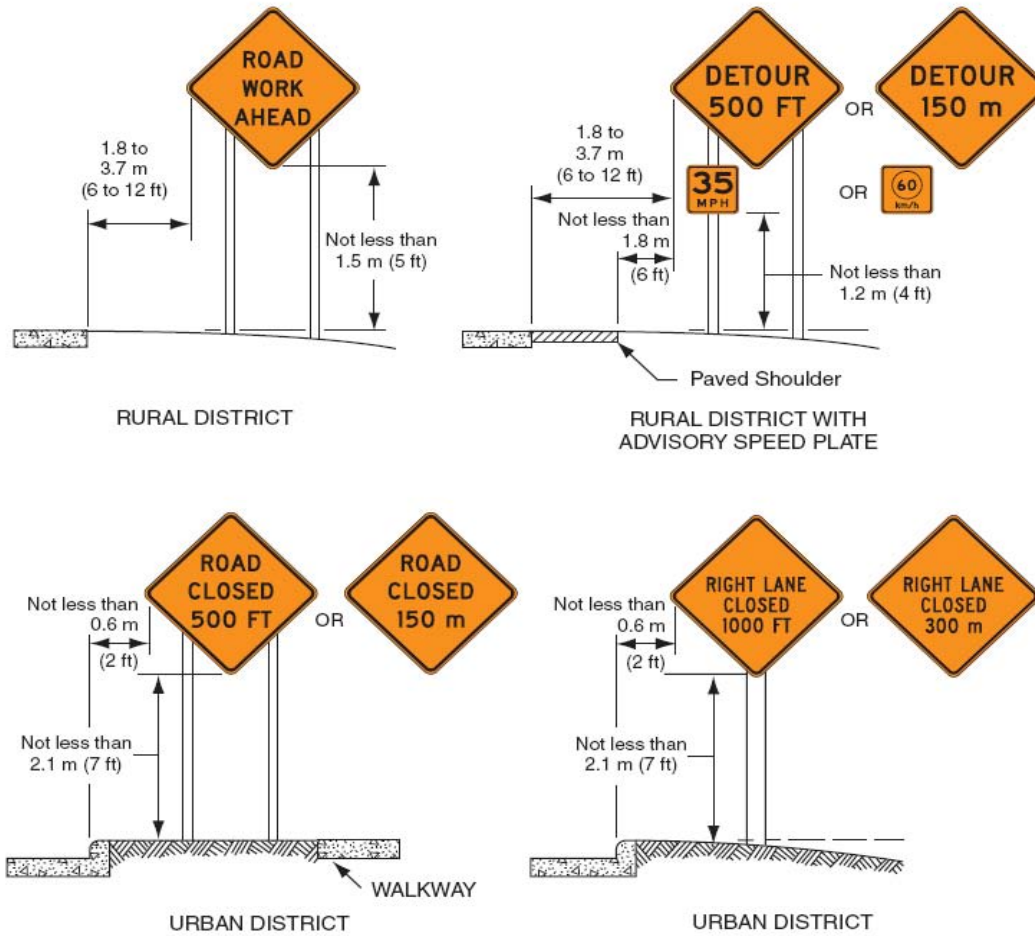

Figure 7-1. Height and Lateral Location of Signs-Typical Installations

**Standard:**

**Signs shall be post-mounted on fixed supports for any work that occurs for a duration of more than three consecutive days (72 hours).**

*Guidance:*

*For operations that occur for a duration of less than three consecutive days (72 hours), portable spring-loaded sign supports should be used.*

**Standard:**

**Sign supports shall be crashworthy. Large signs having an area exceeding 50 square feet that are installed on multiple breakaway posts shall be mounted a minimum of seven feet above the ground.**

**Portable sign supports shall meet the following conditions: accommodate signs of all standard shapes; including octagonal and triangular; have a flag holder which will accommodate two flags as an integral part of the unit; have adjustable legs capable of adjusting to uneven surfaces; and while supporting a 16 square foot rigid sign panel, the sign support shall be spring loaded and shall withstand 50 mph winds without tipping over or rotating more than five degrees about its vertical axis without the use of tie downs or ballast of any kind. The complete unit shall not exceed 40 pounds. The unit shall meet NCHRP 350 crashworthy standards.**

**Signs mounted on portable supports shall be no less than one foot above the traveled way from the bottom of the sign.**

*Guidance:*

*For mobile operations, a sign should be mounted on a work vehicle, a shadow vehicle, or on the shoulder stationed in advance of the temporary traffic control zone or moving along with it.*

*Guidance:*

*Sign posts placed in the clear zone should yield or break away upon impact to minimize obstructions to road users and to not present an undue risk to workers.*

**Support:**

Depending upon the crash tested design, slight variations to the support might not be considered crashworthy.

*Guidance:*

*These supports should meet the breakaway requirements for permanent installations discussed in the AASHTO Roadside Design Guide.*

Option:

The R9-8 through R9-11a series, R11 series, W1-6 through W1-8 series, M4-10, E5-1, or other similar type signs may be used on portable supports for longer than three days.

Support:

Methods of mounting signs other than on posts are illustrated in Figure 6F-2 of the MUTCD.

*Guidance:*

*Signs mounted on Type III barricades should not cover more than 50 percent of the top two rails or 33 percent of the total area of the three rails.*

#### **7.4 SIGN MAINTENANCE**

Support:

Signs used in temporary traffic control zones are moved frequently, loaded and unloaded from trucks, and in general receive much harsher treatment than permanent signs. For this reason, particular attention must be given to maintaining signs properly for cleanliness, visibility, and correct positioning.

**Standard:**

**Signs shall be properly maintained for cleanliness, visibility, and correct positioning. Signs that have lost significant legibility shall be promptly replaced in accordance with the American Traffic Safety Service Association (ATSSA)'s *Quality Standards for Work Zone Traffic Control Devices*.**

#### **7.5 REGULATORY SIGN AUTHORITY**

Support:

Regulatory signs such as those shown in Figures 7-2 and 7-3 inform road users of traffic laws or regulations and indicate the applicability of legal requirements that would not otherwise be apparent.

**Standard:**

**Regulatory signs impose legal obligations on all motorists, and they shall be authorized by the DDOT Engineer or an official having jurisdiction and conform to Chapter 2B of the MUTCD.**

**7.6 REGULATORY SIGN DESIGN**

**Standard:**

**Temporary traffic control regulatory signs shall conform to the Standards for Regulatory Signs presented in Part 2 of the MUTCD and in the FHWA's "*Standard Highway Signs*" book.**

**Support:**

Regulatory signs are generally rectangular with a black legend and border on a white background. Exceptions include the STOP, YIELD, DO NOT ENTER, WRONG WAY, and ONE WAY signs.

Option:

The ONE WAY sign may be either a horizontal or vertical rectangular sign.

**7.7 REGULATORY SIGN APPLICATIONS**

**Standard:**

**If a temporary traffic control zone requires regulatory measures different from those existing, the existing permanent regulatory devices shall be removed or covered and superseded by the appropriate temporary regulatory signs. This change shall be made in conformance with applicable ordinances or statutes of the jurisdiction as well as comply with the sign design standards of the MUTCD.**

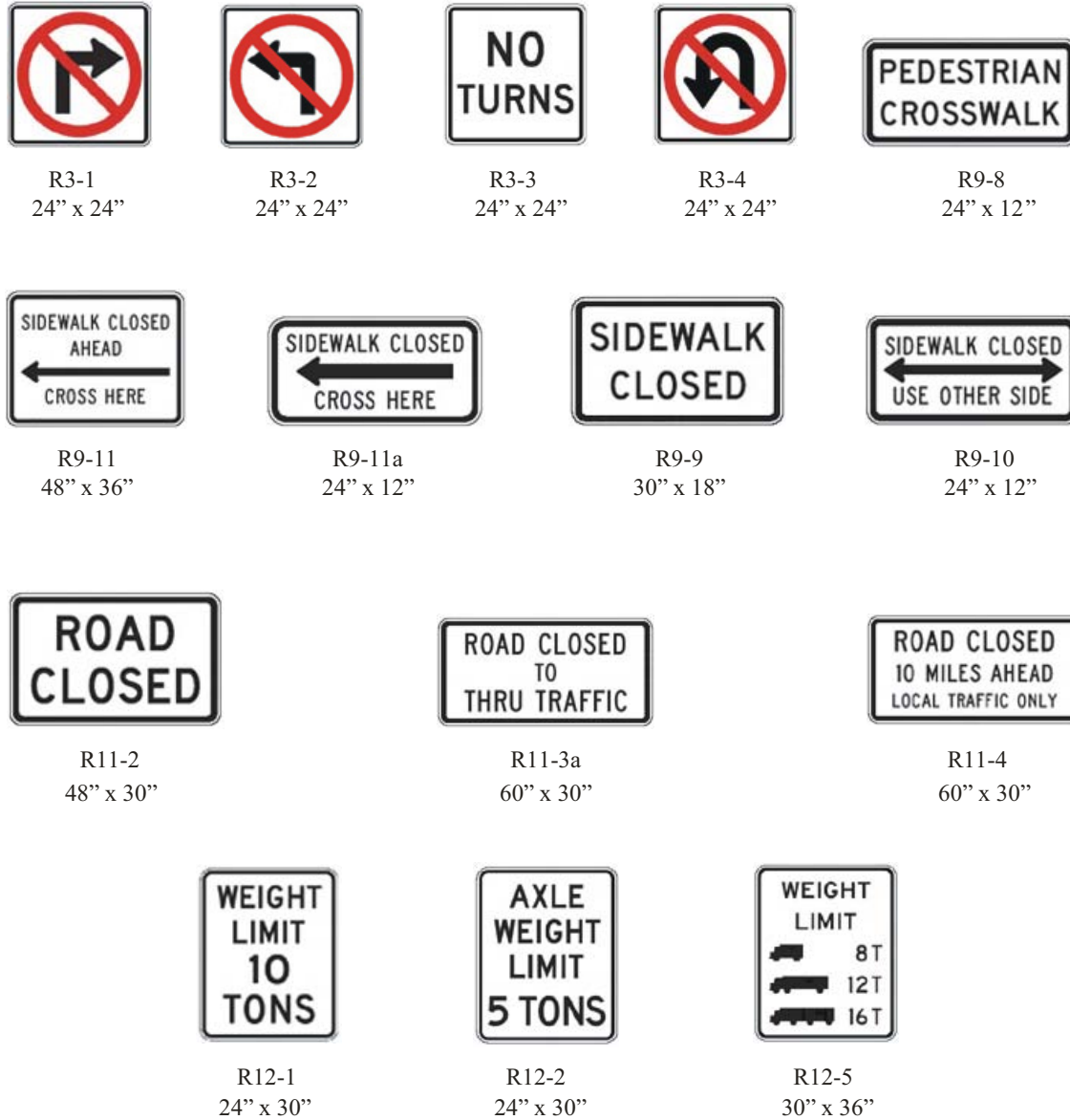

Figure 7-2. Commonly Used Regulatory Signs



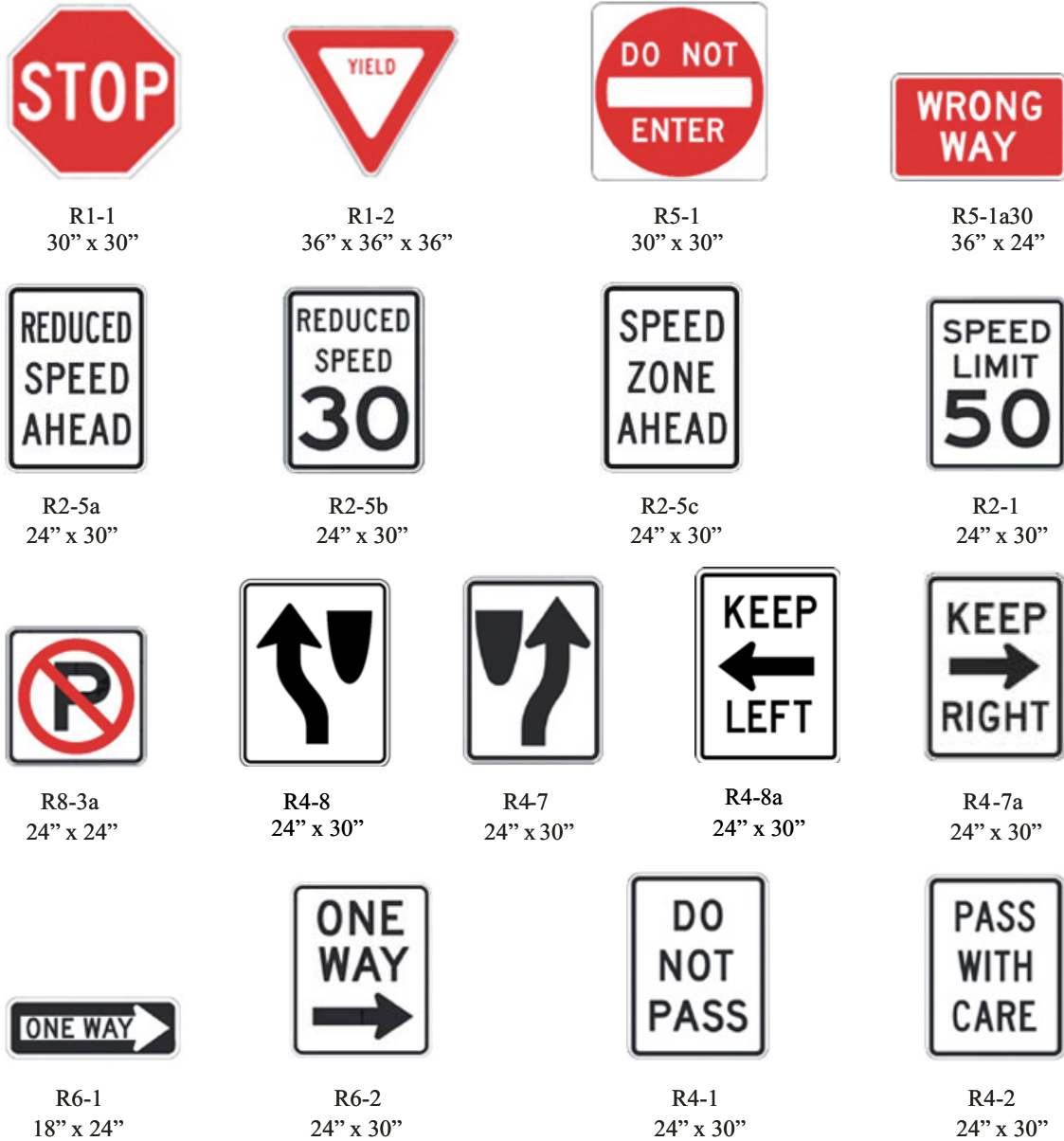

Figure 7-3. Commonly Used Regulatory Signs

**7.7.1 ADVANCE WARNING SIGNS**

**Standard:**

**For all roads functionally classified as major arterials or above, an Advance Warning Sign shall carry the legend of “XX Miles” or “XX Feet” in advance of the work area.**

**For all roads functionally classified as minor arterials or below, Advance Warning Sign shall carry the legend of “XX Blocks” or “XX Feet,” or a legend deemed necessary by the DDOT Engineer, in advance of the work zone.**

*Guidance:*

*The ROAD (STREET) CLOSED (R11-2) sign should be used when the roadway is closed to all road users except contractors' equipment or officially authorized vehicles. The R11-2 sign should be accompanied by appropriate warning and detour signing.*

Option:

The words BRIDGE OUT (or BRIDGE CLOSED) may be substituted for ROAD (STREET) CLOSED where applicable.

*Guidance:*

*The ROAD (STREET) CLOSED sign should be installed at or near the center of the roadway on or above a Type III barricade that closes the roadway.*

**Standard:**

**The ROAD (STREET) CLOSED sign shall not be used where road user flow is maintained or where the actual closure is some distance beyond the sign.**

*Guidance:*

*The LOCAL TRAFFIC ONLY (R11-3a, R11-4) signs should be used where road user flow detours to avoid a closure some distance beyond the sign but where local road users can use the roadway to the point of closure. Appropriate warning and detour signing should accompany these signs.*

*In residential applications, the Local Traffic Only sign should have the legend ROAD CLOSED XX BLOCKS (OR XX FEET) AHEAD, LOCAL TRAFFIC ONLY (R11-3a).*

Option:

In urban areas, the legend ROAD (STREET) CLOSED TO THRU TRAFFIC (R11-4) or ROAD CLOSED, LOCAL TRAFFIC ONLY may be used.

The words BRIDGE OUT (or BRIDGE CLOSED) may be substituted for the words ROAD (STREET) CLOSED on the R11-3a or R11-4 sign where applicable.

**Standard:**

**The sign shall carry the legend ROAD CLOSED [XX] BLOCKS (OR XX FEET) AHEAD - LOCAL TRAFFIC ONLY or, optionally for urban use, ROAD (STREET) CLOSED TO THRU TRAFFIC.**

**WEIGHT LIMIT signs (R12-1, R12-2, R12-5), which shows the gross weight or axle weight that is permitted on the roadway or bridge, shall be consistent with District or local regulations and shall not be installed without the approval of the authority having jurisdiction over the highway.**

**When weight restrictions are imposed, a marked detour shall be provided for vehicles weighing more than the posted limit.**

Option:

A STAY IN LANE (R4-9) sign may be used where a multilane shift has been incorporated as part of the temporary traffic control on a highway to direct road users around road work that occupies part of the roadway on a multilane highway.

The PEDESTRIAN CROSSWALK (R9-8) sign may be used to indicate where a temporary crosswalk has been established.

*Guidance:*

*SIDEWALK CLOSED signs (R9-9, R9-10, R9-11, R9-11a) should be used where pedestrian flow is restricted or rerouted by work activities.*

*The SIDEWALK CLOSED (R9-9) sign should be installed at the beginning of the closed sidewalk area on both sides of the work zone.*

*The SIDEWALK CLOSED, (ARROW) USE OTHER SIDE (R9-10) sign should be installed at the beginning of the restricted sidewalk when a parallel sidewalk exists on the other side of the roadway.*

*The SIDEWALK CLOSED AHEAD, (ARROW) CROSS HERE (R9-11) sign should be used to indicate to pedestrians that sidewalks beyond the sign are closed and to direct them to open crosswalks, sidewalks, or other travel paths.*

*The SIDEWALK CLOSED, (ARROW) CROSS HERE (R9-11a) sign should be installed just beyond the point to which pedestrians are being redirected.*

Support:

These signs are typically mounted on a 4-foot wide barricade to encourage compliance.

### **7.7.2 SPECIAL REGULATORY SIGNS**

Option:

Special regulatory signs may be used based on engineering judgment consistent with regulatory requirements.

*Guidance:*

*Special regulatory signs should conform to the general requirements of color, shape, and alphabet size and series. The sign message should be brief, legible, and clear.*

### **7.7.3 WARNING SIGNS: FUNCTION, DESIGN, AND APPLICATION**

Support:

Temporary Traffic Control (TTC) zone warning signs (see Figure 7-4) notify road users of specific situations or conditions on or adjacent to a roadway that might not otherwise be apparent.

**Standard:**

**TTC warning signs shall conform to the Standards for warning signs presented in Part 2 of the MUTCD and in FHWA's "Standard Highway Signs" book (see Section 1A.11). Except as noted in the Option below, TTC warning signs shall be diamond-shaped with a black legend and border on an orange background, except for the W10-1 sign, which shall have a black legend and border on a yellow background, and except for signs that are permitted in Parts 2 or 7 of the MUTCD to have fluorescent yellow-green backgrounds.**

Option:

Warning signs used for TCC incident management situations may have a black legend and border on a fluorescent pink background.

Mounting or space considerations may justify a change from the standard diamond shape.

In emergencies, available warning signs having yellow backgrounds may be used if signs with orange or fluorescent pink backgrounds are not on hand.

*Guidance:*

*Where roadway or road user conditions require greater emphasis, larger than standard size warning signs should be used, with the symbol or legend enlarged approximately in proportion to the outside dimensions.*

*Where any part of the roadway is obstructed or closed by work activities or incidents, advance warning signs should be installed to alert road users well in advance of these obstructions or restrictions.*

*Where road users include pedestrians, the provision of supplemental audible information or detectable barriers or barricades should be considered for people with visual disabilities.*

**Support:**

Detectable barriers or barricades communicate very clearly to pedestrians who have visual disabilities that they can no longer proceed in the direction that they are traveling.

Option:

Advance warning signs may be used singly or in combination.

**Standard:**

**Because of their importance, advance warning signs for higher-speed locations shall have a size of 48 x 48 inches (see Part 2 of the MUTCD). For freeways and expressways, the size of diamond-shaped TTC warning signs shall be a minimum of 48 x 48 inches.**

Option:

Where speeds and volumes are moderately low, a minimum size of 36 x 36 inches may be used for advance warning signs.

On low-volume / low-speed roads or on residential City streets where speeds are very low, signs smaller than the standard size, but not less than 24 x 24 inches, may be used for warning signs having short word messages or clear symbols.

Advance warning signs larger than the minimum standards may be used for additional emphasis of the TTC zone (see Part 2 of the MUTCD).

Where distances are not shown on warning signs as part of the message, a supplemental plaque with the distance legend may be mounted immediately below the sign on the same support.

#### **7.7.4 POSITION OF ADVANCE WARNING SIGNS**

*Guidance:*

*Where highway conditions permit, warning signs should be placed in advance of the TTC zone at varying distances depending on roadway type, condition, and posted speed. Where a series of two or more advance warning signs is used, the closest sign to the TTC zone should be placed approximately 100 feet for low-speed urban streets to 1,000 feet or more for freeways and expressways.*

**Support:**

Various conditions, such as limited sight distance or obstructions that might require a motorist to reduce speed or stop, might require additional advance warning signs.

Option:

As an alternative to a specific distance on advance warning signs, the word AHEAD may be used.

**Support:**

At TTC zones on lightly-traveled roads, all of the advance warning signs prescribed for major construction might not be needed.

Option:

Utility work, maintenance, or minor construction can occur within the TTC zone limits of a major construction project, and additional warning signs may be needed.

*Guidance:*

*Utility, maintenance, and minor construction signing and TTC should be coordinated with appropriate authorities so that road users are not confused or misled by the additional TTC devices.*

*The ROAD (STREET) WORK (W20-1) sign (see Figure 7-4, Sheet 3 of 3), which serves as a general warning of obstructions or restrictions, should be located in advance of the work space or any detour, on the road where the work is taking place.*

*Where traffic can enter a TTC zone from a crossroad or a major (high-volume) driveway, an advance warning sign should be used on the crossroad or major driveway.*

**Standard:**

The **ROAD (STREET) WORK (W20-1)** sign shall have the legend **ROAD (STREET) WORK, XX BLOCKS, XX FEET, XX MILES, or AHEAD**, as per the functional classification of the road or as deemed necessary by the DDOT Engineer.

*Guidance:*

*The DETOUR (W20-2) sign (see Figure 7-4 Sheet 3 of 3) should be used in advance of a road user detour over a different roadway or route.*

**Standard:**

The **DETOUR** sign shall have the legend **DETOUR, XX BLOCKS, XX FEET, XX MILES, or AHEAD**, as per the functional classification of the road or as deemed necessary by the DDOT Engineer.

*Guidance:*

*The ROAD (STREET) CLOSED (W20-3) sign (see Figure 7-4, Sheet 3 of 3) should be used in advance of the point where a highway is closed to all road users or to all but local road users.*

**Standard:**

The **ROAD (STREET) CLOSED** sign shall have the legend **ROAD (STREET) CLOSED, XX FEET, XX MILES, or AHEAD**, as per the functional classification of the road or as deemed necessary by the DDOT Engineer.

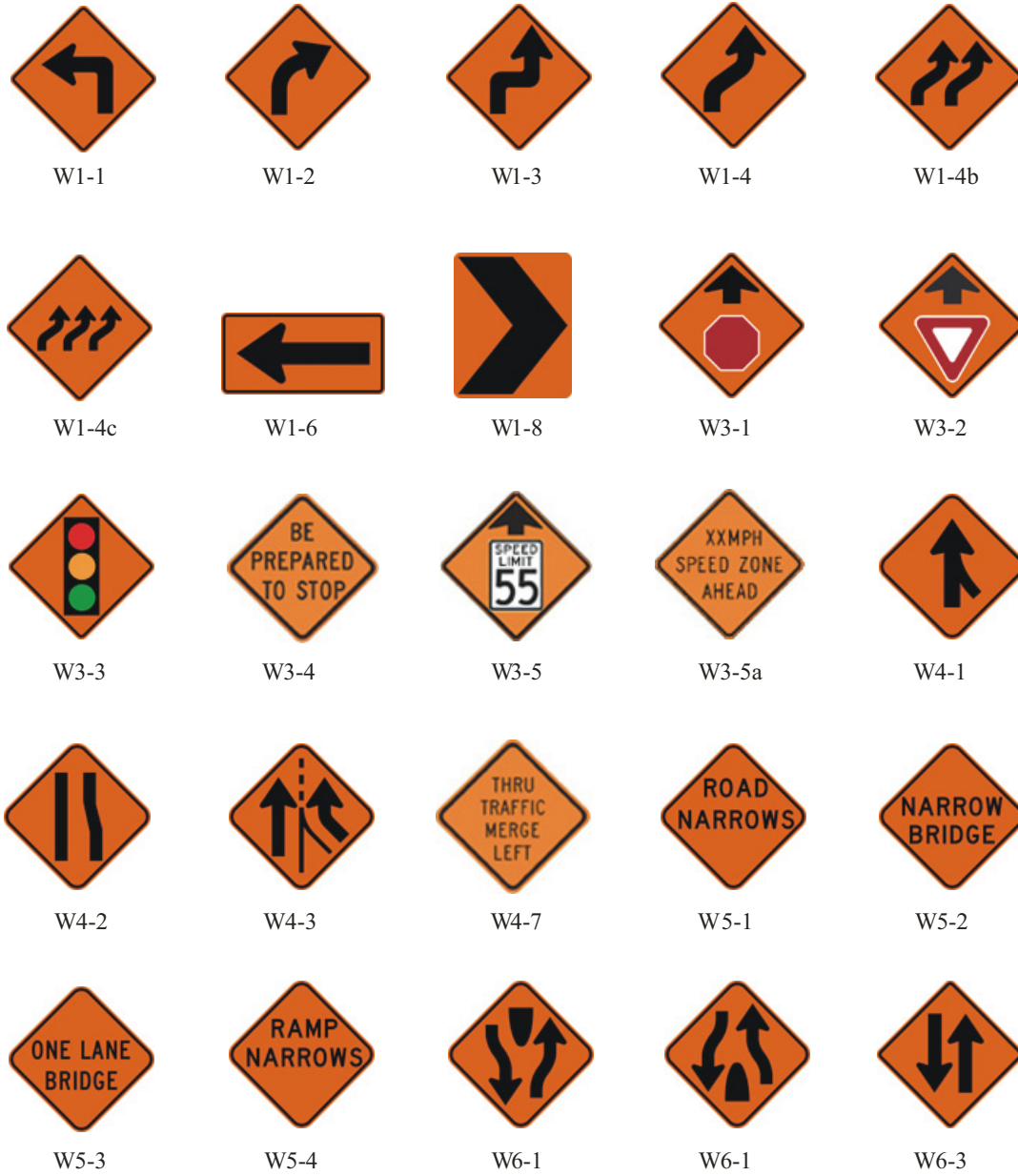

Figure 7-4. Warning Signs in Temporary Traffic Control Zones  
(Sheet 1 of 3)





Figure 7-4. Warning Signs in Temporary Traffic Control Zones  
(Sheet 2 of 3)



Figure 7-4. Warning Signs in Temporary Traffic Control Zones  
(Sheet 3 of 3)

**Standard:**

The ONE LANE ROAD (W20-4) sign (see Figure 7-4, Sheet 3 of 3) shall be used only in advance of that point where motor vehicle traffic in both directions must use a common single lane. It shall have the legend ONE LANE ROAD, XX BLOCKS, XX FEET, XX MILES, or AHEAD, as per the functional classification of the road or as deemed necessary by the DDOT Engineer.

The LANE(S) CLOSED (W20-5, W20-5a) sign (see Figure 7-4, Sheet 3 of 3) shall be used in advance of that point where one or more through lanes of a multi-lane roadway are closed.

For a single lane closure, THE LANE CLOSED (W20-5) sign (see Figure 7-4, Sheet 3 of 3) shall have the legend RIGHT (LEFT) LANE CLOSED, XX BLOCKS, XX FEET, XX MILES, or AHEAD. Where two adjacent lanes are closed, the W20-5a sign (see Figure 7-4, Sheet 3 of 3) shall have the legend RIGHT (LEFT) TWO LANES CLOSED, XX BLOCKS, XX FEET, XX MILES, or AHEAD, as per the functional classification of the road or as deemed necessary by the DDOT Engineer.

*Guidance:*

*The CENTER LANE CLOSED AHEAD (W9-3, W9-3a) sign (see Figure 7-4, Sheet 2 of 3) should be used in advance of that point where work occupies the center lane(s) and approaching motor vehicle traffic is directed to the right or left of the work zone in the center lane.*

Option:

The CENTER LANE CLOSED AHEAD (W9-3a) symbol sign (see Figure 6H-38 of the MUTCD) may be substituted for the CENTER LANE CLOSED AHEAD (W9-3) word message sign.

*Guidance:*

*The THRU TRAFFIC MERGE LEFT (RIGHT) (W4-7) sign (see Figure 7-4, Sheet 1 of 3) should be used in advance of an intersection where one or more lane closures on the far side of a multi-lane intersection require through vehicular traffic on the approach to the intersection to use the left (right) lane to proceed through the intersection.*

Option:

The LANE ENDS (W4-2) symbol sign (see Figure 7-4, Sheet 1 of 3) may be used to warn motorists of the reduction in the number of lanes for moving motor vehicle traffic in the direction of travel on a multi-lane roadway.

*Guidance:*

*When work is being done on a ramp, but the ramp remains open, the ON RAMP (W13-4) plaque (see Figure 7-4, Sheet 3 of 3) should be used to supplement the advance ROAD WORK sign.*

*The RAMP NARROWS (W5-4) sign (see Figure 7-4, Sheet 1 of 3) should be used in advance of the point where work on a ramp reduces the normal width of the ramp along a part or all of the ramp.*

Option:

The SLOW TRAFFIC AHEAD (W23-1) sign (see Figure 7-4, Sheet 3 of 3) may be used on a shadow vehicle, usually mounted on the rear of the most upstream shadow vehicle, along with other appropriate signs for mobile operations to warn of slow moving work vehicles. A ROAD WORK (W20-1) sign may also be used with the SLOW TRAFFIC AHEAD sign.

An EXIT OPEN (E5-2), EXIT CLOSED (E5-2a), or EXIT ONLY (E5-3) sign (see Figure 7-5) may be used to supplement other warning signs where work is being conducted in the vicinity of an exit ramp and where the exit maneuver for motor vehicle traffic using the ramp is different from the normal condition.

*Guidance:*

*When an exit ramp is closed, an EXIT CLOSED panel with a black legend and border on an orange background should be placed diagonally across the interchange/intersection guide signs.*

*The Flagger (W20-7a) symbol sign (see Figure 7-4, Sheet 3 of 3) should be used in advance of any point where a flagger is stationed to control road users.*

Option:

A distance legend may be displayed on a supplemental plaque below the Flagger sign. The sign may be used with appropriate legends or in conjunction with other warning signs, such as the BE PREPARED TO STOP (W3-4) sign (see Figure 7-4, Sheet 1 of 3).

The FLAGGER (W20-7) word message sign with distance legends may be substituted for the Flagger (W20-7a) symbol sign.

**Standard:**

**The Flagger sign shall be removed, covered, or turned away from road users when the flagging operations are not occurring.**

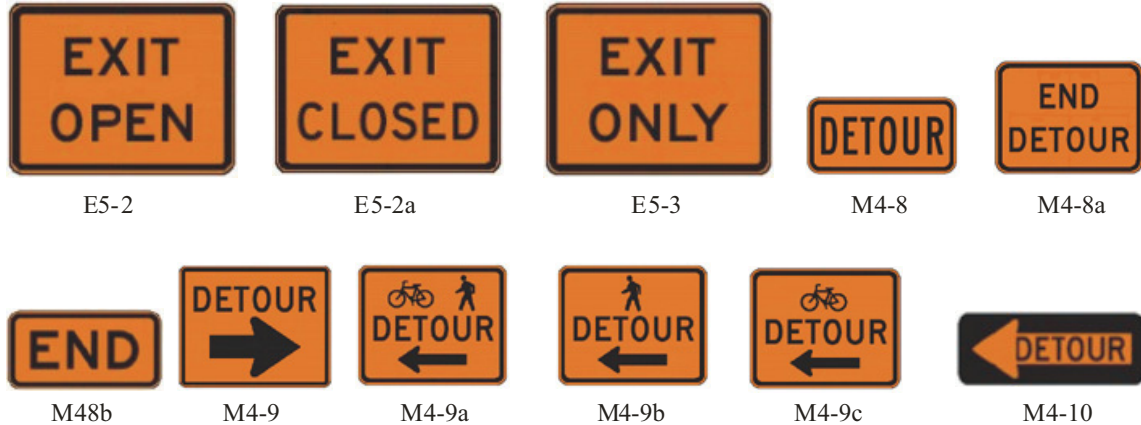

**Figure 7-5. Exit Open and Closed and Detour Signs**

*Guidance:*

*When one roadway of a normally divided highway is closed, with two-way vehicular traffic maintained on the other roadway, the TWO-WAY TRAFFIC (W6-3) sign (see Figure 7-4, Sheet 1 of 3) should be used at the beginning of the two-way vehicular traffic section and at intervals to remind road users of opposing vehicular traffic.*

Option:

A Workers (W21-1a) symbol sign (see Figure 7-4, Sheet 3 of 3) may be used to alert road users of workers in or near the roadway.

*Guidance:*

*In the absence of other warning devices, a Workers symbol sign should be used when workers are in the roadway.*

Option:

The WORKERS (W21-1) word message sign may be used as an alternate to the Workers (W21-1a) symbol sign.

*Guidance:*

*The FRESH OIL (TAR) (W21-2) sign (see Figure 7-4, Sheet 3 of 3) should be used to warn road users of the surface treatment.*

Option:

The ROAD MACHINERY AHEAD (W21-3) sign (see Figure 7-4, Sheet 3 of 3) may be used to warn of machinery operating in or adjacent to the roadway.

Motorized Traffic (W8-6, W11-10) signs may be used to alert road users to locations where unexpected travel on the roadway or entries into or departures from the roadway by construction vehicles might occur. The TRUCK CROSSING (W8-6) word message sign may be used as an alternate to the Truck Crossing symbol (W11-10) sign (see Figure 7-4, Sheet 2 of 3) where there is an established construction vehicle crossing of the roadway.

Support:

These locations might be relatively confined or might occur randomly over a segment of roadway.

**Standard:**

**The Shoulder Work signs (W21-5, W21-5a, W21-5b) shall have the legend SHOULDER WORK (W21-5), RIGHT (LEFT) SHOULDER CLOSED (W21-5a), or RIGHT (LEFT) SHOULDER CLOSED XX FEET or AHEAD (W21-5b).**

Support:

Shoulder Work signs (W21-5, W21-5a, W21-5b) (see Figure 7-4, Sheet 3 of 3) warn of maintenance, reconstruction, or utility operations on the highway shoulder where the roadway is unobstructed.

Option:

The Shoulder Work signs may be used in advance of the point on a non-limited access highway where there is shoulder work. It may be used singly or in combination with a ROAD WORK NEXT XX MILES or XX FEET OR XX BLOCKS or WORK AHEAD sign, as per the functional classification of the road or as deemed necessary by the DDOT Engineer

*Guidance:*

*On freeways and expressways, the RIGHT (LEFT) SHOULDER CLOSED XX FEET or AHEAD (W21-5b) sign followed by RIGHT (LEFT) SHOULDER CLOSED (W21-5a) sign should be used in advance of the point where the shoulder work occurs and should be preceded by a ROAD WORK AHEAD sign.*

*Guidance:*

*The SURVEY CREW (W21-6) sign (see Figure 7-4, Sheet 3 of 3) should be used to warn of surveying crews working in or adjacent to the roadway.*

Option:

The UTILITY WORK (W21-7) sign (see Figure 7-4, Sheet 4 of 3) may be used as an alternate to the ROAD (STREET) WORK (W20-1) sign for utility operations on or adjacent to a highway.

**Standard:**

**The UTILITY WORK sign shall carry the legend UTILITY WORK, XX BLOCKS, XX FEET, XX MILES, or AHEAD, as per the functional classification of the road or as deemed necessary by the DDOT Engineer.**

Option:

The SOFT SHOULDER (W8-4) sign (see Figure 7-4, Sheet 2 of 3) may be used to warn of a soft shoulder condition.

The LOW SHOULDER (W8-9) sign (see Figure 7-4, Sheet 2 of 3) may be used to warn of a shoulder condition where there is an elevation difference of less than three inches (75 mm) between the shoulder and the travel lane.

*Guidance:*

*The SHOULDER DROP OFF (W8-9a) sign (see Figure 7-4, Sheet 2 of 3) should be used when an unprotected shoulder drop-off, adjacent to the travel lane, exceeds three inches (75 mm) in depth for a continuous length along the roadway, based on engineering judgment.*

*The UNEVEN LANES (W8-11) sign (see Figure 7-4, Sheet 2 of 3) should be used during operations that create a difference in elevation between adjacent lanes that are open to travel.*

*The NO CENTER STRIPE (W8-12) sign (see Figure 7-4, Sheet 3 of 3) should be used when the work obliterates the centerline pavement markings. This sign should be placed at the beginning of the TTC zone and repeated at XX feet intervals in long TTC zones.*

Option:

The DOUBLE REVERSE CURVE (W24-1, W24-1a, or W24-1b) sign (see Figure 7-4, Sheet 3 of 3) may be used when the tangent distance between two reverse curves is less than 600 feet (180 meters), thus making it difficult for a second Reverse Curve (W1-4 Series) sign to be placed between the curves.

**Standard:**

**If a DOUBLE REVERSE CURVE sign is used, the number of lanes illustrated on the sign shall be the same as the number of through lanes available to road users, and the direction of the double reverse curve shall be appropriately illustrated.**

**7.7.5 OTHER WARNING SIGNS**

Option:

Advance warning signs may be used by themselves or with other advance warning signs.

Besides the warning signs specifically related to TTC zones, several other warning signs in Part 2 may apply in TTC zones.

**Standard:**

**Except as noted previously, other warning signs that are used in TTC zones shall have black legends and borders on an orange background.**

**7.7.6 SPECIAL WARNING SIGNS**

Option:

Special warning signs may be used based on engineering judgment.

*Guidance:*

*Special warning signs should conform to the general requirements of color, shape, and alphabet size and series. The sign message should be brief, legible, and clear.*

Option:

In combination with a warning sign, an Advisory Speed (W13-1) plaque (see Figure 7-4, Sheet 2 of 3) may be used to indicate a recommended safe speed through the TTC zone.

**Standard:**

**The Advisory Speed plaque shall not be used in conjunction with any sign other than a warning sign, nor shall it be used alone. When used with orange Temporary**



Traffic Control (TTC) zone signs, this plaque shall have a black legend and border on an orange background. The sign shall be at least 24 x 24 inches (600 x 600 mm) in size when used with a sign that is 36 x 36 inches (900 x 900 mm) or larger. Except in emergencies, an Advisory Speed plaque shall not be mounted until the recommended speed is determined by the highway agency.

Option:

In combination with a warning sign, a Supplementary Distance (W7-3a) plaque with the legend NEXT XX MILES or XX FEET, as deemed necessary by the DDOT Engineer, may be used to indicate the length of highway over which a work activity is being conducted or over which a condition exists in the TTC zone.

In long TTC zones, Supplementary Distance plaques with the legend NEXT XX MILES or XX FEET, as per functional classification or as deemed necessary by the DDOT Engineer, may be placed in combination with warning signs at regular intervals within the zone to indicate the remaining length of highway over which the TTC work activity or condition exists.

**Standard:**

**The Supplementary Distance plaque with the legend NEXT XX MILES or XX FEET or XX BLOCK shall not be used in conjunction with any sign other than a warning sign, nor shall it be used alone. When used with orange TTC zone signs, this plaque shall have a black legend and border on an orange background. The sign shall be at least 30 x 24 inches in size when used with a sign that is 36 x 36 inches or larger.**

*Guidance:*

*When used in Temporary Traffic Control zones, the Supplementary Distance plaque with the legend NEXT XX MILES or XX FEET, as per the functional classification of the road or as deemed necessary by the DDOT Engineer, should be placed below the initial warning sign designating that, within the approaching zone, a temporary work activity or condition exists.*

## **7.8 GUIDE SIGNS**

**Support:**

Guide signs along highways provide road users with information to help them along their way through the TTC zone. The design of guide signs is presented in Part 2 of the MUTCD.

*Guidance:*

*The following guide signs should be used in TTC zones as needed:*

- A. *Standard route markings, where temporary route changes are necessary*
- B. *Directional signs and street name signs*
- C. *Special guide signs relating to the condition or work being done*

**Standard:**

**If additional temporary guide signs are used in TTC zones, they shall have a black legend and border on an orange background.**

Option:

Guide signs used in TTC incident management situations may have a black legend and border on a fluorescent pink background.

When directional signs and street name signs are used in conjunction with detour routing, these signs may have a black legend and border on an orange background.

When permanent directional signs or permanent street name signs are used in conjunction with detour signing, they may have a white legend on a green background.

*Guidance:*

*The ROAD WORK NEXT XX MILES (G20-1) sign (see Figure 7-4, Sheet 3 of 3) should be installed in advance of TTC zones that are more than two miles in length.*

Option:

The ROAD WORK NEXT XX MILES sign may be mounted on a Type III barricade. The sign may also be used for TTC zones of shorter length.

**Standard:**

**The distance shown on the ROAD WORK NEXT XX MILES sign shall be stated to the nearest whole mile.**

*Guidance:*

*When used, the END ROAD WORK (G20-2) sign (see Figure 7-4, Sheet 3 of 3) should be placed near the end of the termination area, as determined by engineering judgment.*

Option:

The END ROAD WORK sign may be installed on the back of a warning sign facing the opposite direction of road users or on the back of a Type III barricade.

## 7.9 DETOUR SIGNS

### Standard:

**Each detour shall be adequately marked with standard temporary route signs and destination signs.**

### Option:

Detour signs in TTC incident management situations may have a black legend and border on a fluorescent pink background.

The Detour Arrow (M4-10) sign (see Figure 7-5) may be used where a detour route has been established.

The DETOUR (M4-8) sign (see Figure 7-5) may be mounted at the top of a route sign assembly to mark a temporary route that detours from a highway, bypasses a section closed by a TTC zone, and rejoins the highway beyond the TTC zone.

### Guidance:

*The Detour Arrow (M4-10) sign should normally be mounted just below the ROAD CLOSED (R11-2, R11-3a, or R11-4) sign. The Detour Arrow sign should include a horizontal arrow pointed to the right or left as required.*

*The DETOUR (M4-9) sign (see Figure 7-5) should be used for unnumbered highways, for emergency situations, for periods of short durations, or where, over relatively short distances, road users are guided along the detour and back to the desired highway without route signs.*

*A Street Name sign should be placed above, or the street name should be incorporated into, a DETOUR (M4-9) sign to indicate the name of the street being detoured.*

### Option:

The END DETOUR (M4-8a) or END (M4-8b) sign (see Figure 7-5) may be used to indicate that the detour has ended.

### Guidance:

*When the END DETOUR sign is used on a numbered highway, the sign should be mounted above a sign after the end of the detour.*

*The Pedestrian/Bicycle Detour (M4-9a) sign (see Figure 7-5) should be used where a pedestrian/bicycle detour route has been established because of the closing of a pedestrian/bicycle facility to through traffic.*

**Standard:**

**If used, the Pedestrian/Bicycle Detour sign shall have an arrow pointing in the appropriate direction.**

**Option:**

The arrow on a Pedestrian/Bicycle Detour sign may be on the sign face or on a supplemental plaque.

The Pedestrian Detour (M4-9b) sign or Bicycle Detour (M4-9c) sign (see Figure 7-5) may be used where a pedestrian or bicycle detour route (not both) has been established because of the closing of the pedestrian or bicycle facility to through traffic.

**7.10 PILOT CAR SIGNS****Standard:**

**The PILOT CAR FOLLOW ME (G20-4) sign shall be mounted in a conspicuous position on the rear of a vehicle used for guiding one-way motor vehicle traffic through or around a temporary traffic control zone. A flagger shall be stationed on the approach to the activity area to stop motor vehicle traffic until the pilot vehicle is available.**

**7.11 PORTABLE CHANGEABLE MESSAGE SIGNS****Standard:**

**Portable Changeable Message Signs (PCMS) shall be temporary traffic control devices with the flexibility to display a variety of messages. Each message shall consist of either one or two phases. A phase shall consist of up to three lines of eight characters per line. Each character module shall use at least a five wide and seven high pixel matrix.**

**Support:**

Portable Changeable Message signs are used most frequently on high-density urban freeways, but have applications on all types of highways where highway alignment, road user routing problems, or other pertinent conditions require advance warning and information.

**Guidance:**

*The components of a Portable Changeable Message sign should include a message sign panel, control systems, a power source, and mounting and transporting equipment.*

*Portable Changeable Message signs should subscribe to the principles established in this Manual and, to the extent practical, with the design (color, letter size and shape, and borders) and applications prescribed in this Manual, except that the reverse colors for the letters and the background are considered acceptable.*

*The front face of the sign should be covered with a protective material. The color of the elements should be yellow or orange on a black background.*

*Portable Changeable Message signs should be visible from 0.5 miles under both day and night conditions. For a trailer or large truck mounted sign, the letter height should be a minimum of 18 inches. For Portable Changeable Message signs mounted on the back of service patrol trucks or work trucks, the letter height should be a minimum of 10 inches. The message should be legible from a minimum distance of 650 feet for Portable Changeable Message signs mounted on a trailer or large truck and 330 feet for Portable Changeable Message signs mounted on service patrol or work trucks.*

*The message panel should have adjustable display rates, so that the entire message can be read at least twice at the posted speed, the off-peak 85th-percentile speed prior to work starting, or the anticipated operating speed.*

*Messages should be designed taking into account the following factors:*

- A. Each Phase should convey a single thought.*
- B. If the message can be displayed in one phase, the top line should present the problem, the center line should present the location or distance ahead, and the bottom line should present the recommended motorist action.*
- C. The message should be brief as possible.*
- D. When a message is longer than two phases, additional Portable Changeable Message signs should be used.*
- E. When abbreviations are used, they should be easily understood (see Table of Acceptable Abbreviations).*

**Option:**

The message sign panel may vary in size.

**Standard:**

**Portable Changeable Message signs shall automatically adjust their brightness under varying light conditions to maintain legibility.**

**The control system shall include a display screen upon which messages can be reviewed before being displayed on the message sign. The control system shall be capable of maintaining memory when power is unavailable.**

**Portable Changeable Message signs shall be equipped with a power source and a battery back-up to provide continuous operation when failure of the primary power source occurs.**

**The mounting of Portable Changeable Message signs shall be such that the bottom of the message sign panel shall be a minimum of seven feet above the roadway when it is in the operating mode.**

**The text of the messages shall not scroll or travel horizontally or vertically across the face of the sign.**

Support:

Portable Changeable Message signs have a wide variety of applications in temporary traffic control zones including roadway, lane, or ramp closures; crash or emergency incident management; width restriction information; speed reductions; advisories on work scheduling; road user management and diversion; warning of adverse conditions; and operation control.

*Guidance:*

*Portable Changeable Message signs should be used as a supplement to and not as a substitute for conventional signs and pavement markings.*

Support:

The primary purpose of Portable Changeable Message signs in temporary traffic control zones is to advise the road user of unexpected situations. Some typical applications include the following:

- A. Where the speed of motor vehicle traffic is expected to drop substantially
- B. Where significant queuing and delays are expected
- C. Where adverse environmental conditions are present
- D. Where there are changes in alignment or surface conditions
- E. Where advance notice of ramp, lane, or roadway closures is needed
- F. Where crash or incident management is needed
- G. Where changes in the road user pattern occur

*Guidance:*

*When Portable Changeable Message signs (PCMS) are used for route diversion, they should be placed far enough in advance of the diversion to allow road users ample opportunity to exit the affected highway. The PCMS should be sited and aligned to ensure*

*legibility. Multiple PCMSs should be placed on the same side of the roadway, separated from each other a minimum distance of 1,000 feet.*

*Portable Changeable Message signs should be placed on the shoulder of the roadway or, if practical, further from the traveled lane. They should be delineated with retroreflective temporary traffic control devices or when within the clear zone, shielded with a barrier or crash cushion. When Portable Changeable Message signs are not being used, they should be removed or placed out of the clear zone; if not removed, they should be shielded; or if the previous two options are not feasible, they should be delineated with retroreflective temporary traffic control devices.*

**Standard:**

**When used in unmanned work zones, Group 2 channelizing devices shall be used to delineate Portable Changeable Message signs.**

**Portable Changeable Message sign trailers shall be delineated on a permanent basis by affixing retroreflective material, known as conspicuity material, in a continuous line on the face of the trailer as seen by oncoming road users.**

## **7.12 ARROW PANELS**

**Standard:**

**An arrow panel shall be a sign with a matrix of elements capable of either flashing or sequential displays. This sign shall provide additional warning and directional information to assist in merging and controlling road users through or around a temporary traffic control zone.**

*Guidance:*

*An arrow panel should be used in combination with appropriate signs, channelizing devices, or other temporary traffic control devices.*

*An arrow panel should be placed on the shoulder of the roadway or, if practical, further from the traveled lane. It should be delineated with retroreflective temporary traffic control devices, or when within the clear zone, shielded with a barrier or crash cushion. When an arrow panel is not being used, it should be removed; if not removed, it should be shielded; or if the previous two options are not feasible, it should be delineated with retroreflective temporary traffic control devices.*

**Standard:**

**When used in unmanned work zones, Group 2 channelizing devices shall be used to delineate arrow panels.**

Arrow panel trailers shall be delineated on a permanent basis by affixing retroreflective material, known as conspicuity material, in a continuous line on the face of the trailer as seen by oncoming road users.

Arrow panels shall meet the minimum size, legibility distance, number of elements, and other specifications shown on Figure 7-6 and Table 7-1.



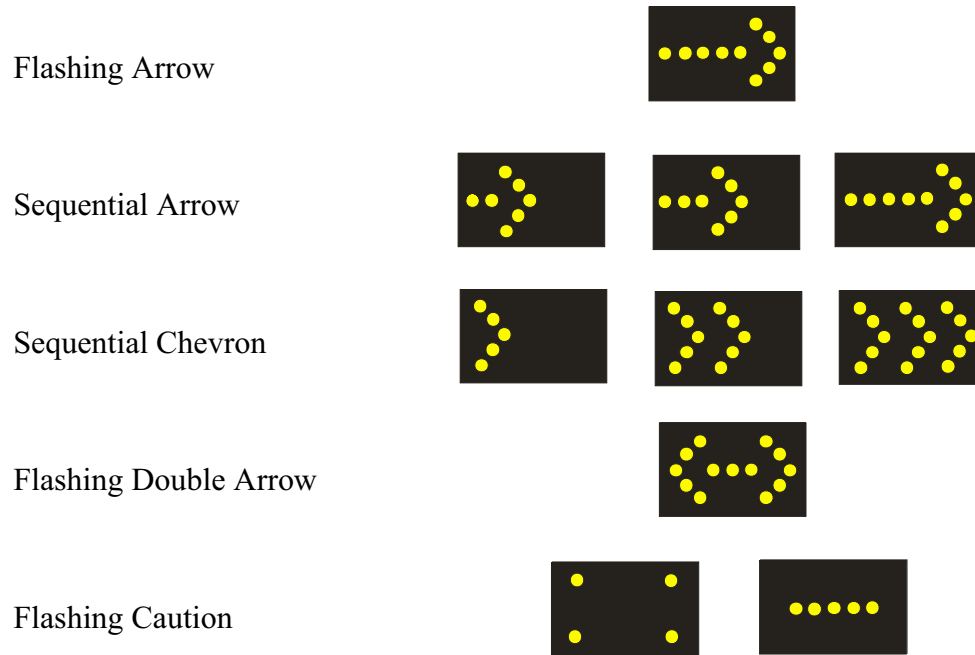

**Figure 7-6. Arrow panel displays**

**Support:**

Type A arrow panels are appropriate for use on low-speed (below 35 mph) urban streets. Type B arrow panels are appropriate for intermediate-speed (35 mph to 44 mph) facilities and for maintenance or mobile operations on high-speed (45 mph and greater) roadways. Type C arrow panels are intended to be used on high-speed, high-volume motor vehicle traffic control projects.

**Standard:**

**Type A, B, and C arrow panels shall have solid rectangular appearances.**

**All arrow panels shall be finished in nonreflective black. The arrow panel shall be mounted on a vehicle, a trailer, or other suitable support.**

Table 7-1. Arrow Panel Display Standards

Arrow Panels		
Type	Minimum Size	Minimum Lamps
A	24' x 48'	12
B	30' x 60'	13
C	48' x 96'	15

*Guidance:*

*The minimum mounting height of an arrow panel should be seven feet from the roadway to the bottom of the panel, except on vehicle-mounted panels, which should be as high as practical.*

*A vehicle-mounted arrow panel should be provided with remote controls.*

**Standard:**

**Arrow panel elements shall be capable of at least 50 percent dimming from full brilliance. The dimmed mode shall be used for nighttime operation of arrow panels.**

*Guidance:*

*Full brilliance should be used for daytime operation of arrow panels.*

**Standard:**

**The arrow panel shall have suitable elements capable of the various operating modes. The color presented by the elements shall be yellow.**

*Guidance:*

*If an arrow panel consisting of a bulb matrix is used, the elements should be recess-mounted or equipped with an upper hood of not less than 180 degrees.*

**Standard:**

**The minimum element on-time shall be 50 percent for the flashing mode, with equal intervals of 25 percent for each sequential phase. The flashing rate shall be not less than 25, nor more than 40, flashes per minute.**

**An arrow panel shall have the following three mode selections:**

1. A Flashing Arrow, Sequential Arrow, or Sequential Chevron mode
2. A Flashing Double Arrow mode
3. A Flashing Caution mode

**An arrow panel in the arrow or chevron mode shall be used only for stationary or moving lane closures on multi-lane roadways.**

**For shoulder work blocking the shoulder, for roadside work near the shoulder, or for temporarily closing one lane on a two-lane, two-way roadway, an arrow panel shall be used only in the caution mode.**

*Guidance:*

*For a stationary lane closure, the arrow panel should be located on the shoulder at the beginning of the merging taper. Where the shoulder is narrow, the arrow panel should be located in the closed lane.*

**Standard:**

**When arrow panels are used to close multiple lanes, a separate arrow panel shall be used for each closed lane.**

*Guidance:*

*When arrow panels are used to close multiple lanes, if the first arrow panel is placed on the shoulder, the second arrow panel should be placed in the first closed lane at the beginning of the second merging taper. When the first arrow panel is placed in the first closed lane, the second arrow panel should be placed in the second closed lane at the downstream end of the second merging taper.*

*For mobile operations where a lane is closed, the arrow panel should be located to provide adequate separation from the work operation to allow for appropriate reaction by approaching motorists.*

**Standard:**

**A vehicle displaying an arrow panel shall be equipped with high-intensity rotating, flashing, oscillating, or strobe lights.**

**Arrow panel(s) shall not be used to laterally shift traffic.**

Option:

A portable changeable message sign may be used to simulate an arrow panel display.

**7.13 HIGH-LEVEL WARNING DEVICES (FLAG TREES)**

Option:

A high-level warning device (flag tree) may supplement other temporary traffic control devices in temporary traffic control zones.

Support:

A high-level warning device is designed to be seen over the top of typical passenger cars.

**Standard:**

**A high-level warning device shall consist of a minimum of two flags with or without a Type B high-intensity flashing warning light. The distance from the roadway to the bottom of the lens of the light and to the lowest point of the flag material shall be not less than eight feet. The flag shall be 16 inches square or larger and shall be orange or fluorescent red-orange in color.**

Option:

An appropriate warning sign may be mounted below the flags.

Support:

High-level warning devices are most commonly used in high-density road user situations to warn road users of short-term operations.

**7.14 CHANNELIZING DEVICES**

**Standard:**

**Designs of various channelizing devices shall be as shown in Figure 7-7.**

Support:

The function of channelizing devices is to warn road users of conditions created by work activities in or near the roadway and to guide road users. Channelizing devices include cones, tubular markers, vertical panels, plastic drums, barricades, and temporary raised islands.

Channelizing devices provide for smooth and gradual motor vehicle traffic flow from one lane to another, onto a bypass or detour, or into a narrower traveled way. They are also used to separate motor vehicle traffic from the work space, pavement drop-offs, pedestrian or bicycle paths, or opposing directions of motor vehicle traffic.

*Guidance:*

*Channelizing devices should be constructed and ballasted to perform in a predictable manner when inadvertently struck by a vehicle. Channelizing devices should be crashworthy.*

*Fragments or other debris from the device or the ballast should not pose a significant hazard to road users or workers in the immediate area.*

*The spacing of channelizing devices should be as shown in Table 7-2. The spacing of channelizing devices in tangent sections of the work zone is normally twice the distance for devices used in the taper and around curves of six degrees and greater.*

*When channelizing devices have the potential of leading motor vehicle traffic out of the intended motor vehicle traffic space, the channelizing devices should be extended a distance in feet of two times the speed limit in mph beyond the end of the transition area.*

*Channelizing devices are elements in a total system of traffic control devices for use in temporary traffic control zones. These elements shall be preceded by a subsystem of warning devices that are adequate in size, number, and placement for the type of highway on which the work is to take place. Standard designs of channelizing devices are shown in Figure 7-7.*

Option:

Warning lights may be added to channelizing devices in areas with frequent fog, snow, or severe roadway curvature, or where visual distractions are present.

**Standard:**

**Warning lights shall flash when placed on channelizing devices used alone or in a cluster to warn of a condition. Warning lights placed on channelizing devices used in a series to channelize road users shall be steady-burn. Barrier vertical panels shall not be installed on Group 1 or 2 channelizing devices.**

**The retroreflective material used on channelizing devices shall have a smooth, sealed outer surface that will display approximately the same color day or night. In addition to conforming to the requirements stated herein, channelizing devices, including retro-reflective material, shall conform to the requirements of the District Department of Transportation's Road and Bridge Specifications.**

Option:

The name and telephone number of the highway agency, contractor, or supplier may be shown on the non-retroreflective surface of all types of channelizing devices.

**Standard:**

**The letters and numbers of the name and telephone number shall be non-retroreflective and not over two inches in height.**

*Guidance:*

*Particular attention should be given to maintaining the channelizing devices to keep them clean, visible, and properly positioned at all times.*

**Standard:**

**Devices that are damaged or have lost a significant amount of their retroreflectivity and effectiveness shall be replaced. Replacement and correction of ineffective channelizing devices shall be accomplished in accordance with the American Traffic Safety Service Association (ATSSA)'s *Quality Standards for Work Zone Traffic Control Devices*'.**

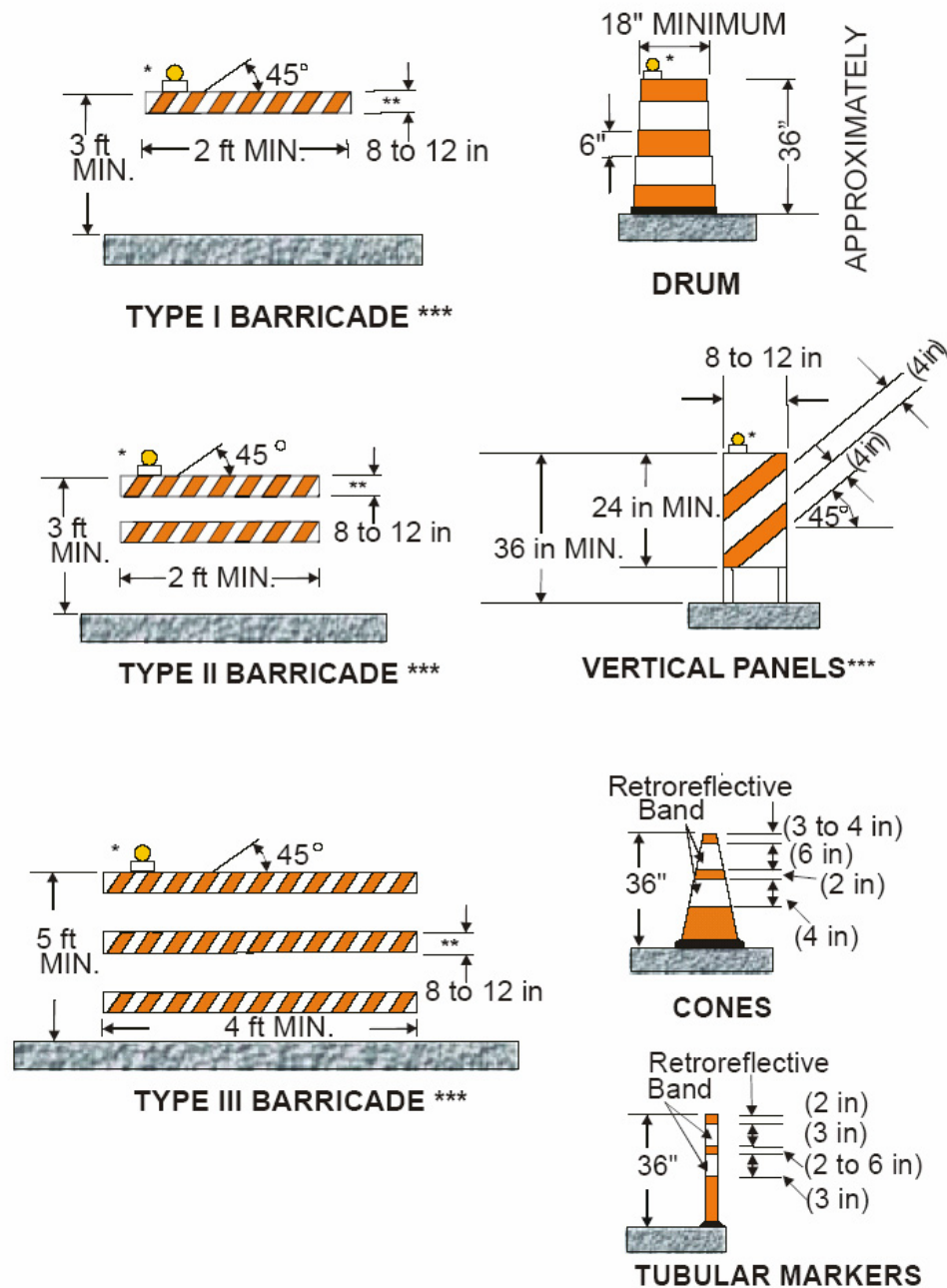

\*Warning lights (optional)

\*\*Normal lumber dimensions are satisfactory for barricade rail width dimensions.

\*\*\*Rail stripe widths shall be 6 inches, except that 4 inch wide stripes may be used if rail lengths are less than 36 inches.

The sides of barricades facing traffic shall have retroreflective rail faces

Figure 7-7. Channelizing devices

Table 7-2. Spacing of Channelizing Devices

Channelizing Device Spacing		
Work Zone Location	Posted Speed Limit	Spacing
Low-Speed Road	20 mph or less	10'
In Transitions and Curves	35 mph or less	20'
Parallel to the Travelway	35 mph or less	40'
Spot Construction Access*	35 mph or less	80'
In Transitions and Curves	Greater than 35 mph	40'
Parallel to the Travelway	Greater than 35 mph	80'
Spot Construction Access*	Greater than 35 mph	120'
*For easier access by construction vehicles into the work area, spacing may be increased to this distance, but shall not exceed one access per quarter mile.		

#### 7.14.1 CONES

##### Standard:

Cones shall be predominantly orange and shall be made of a material that can be struck without causing damage to the impacting vehicle. The height of cones for use on all roadways shall be 36 inches.

For nighttime use, cones shall be retroreflectorized or equipped with lighting devices for maximum visibility. Retroreflectorization of cones shall be provided by a minimum 13-inch white band placed a maximum of three inches from the top, or by a white band six inches wide located three to four inches from the top of the cone and an additional 4 inch wide white band approximately two inches below the 6-inch band.

##### Option:

When workers are present to maintain them, traffic cones may be used to channelize road users, divide opposing motor vehicle traffic lanes, divide lanes when two or more lanes are kept open in the same direction, and delineate short duration maintenance and utility work.



*Guidance:*

*Steps should be taken to ensure that cones will not be blown over or displaced by wind or moving motor vehicle traffic.*

Option:

Cones may be doubled up to increase their weight.

Support:

Some cones are constructed with bases that can be filled with ballast. Others have specially weighted bases or weight such as sandbag rings that can be dropped over the cones and onto the base to provide added stability.

*Guidance:*

*Ballast should be kept to the minimum amount needed.*

**Standard:**

**When workers are not present on the jobsite to maintain the cones, Group 2 channelizing devices shall be used for channelization.**

#### **7.14.2 TUBULAR MARKERS**

**Standard:**

**Tubular markers (see Figure 7-7) shall be predominantly orange and shall be not less than 36 inches high and two inches wide facing road users. They shall be made of a material that can be struck without causing damage to the impacting vehicle.**

**For nighttime use, tubular markers shall be retroreflectorized. Retroreflectorization of 36 inches or larger tubular markers shall be provided by two 3-inch wide white bands placed a maximum of two inches from the top with a maximum of six inches between the bands.**

*Guidance:*

*Tubular markers have less visible area than other devices and should be used only where space restrictions do not allow for the use of other more visible devices.*

*Tubular markers should be stabilized by affixing them to the pavement, by using weighted bases, or weights such as sandbag rings that can be dropped over the tubular markers and onto the base to provide added stability. Ballast should be kept to the minimum amount needed.*

**Option:**

Tubular markers may be used effectively to divide opposing lanes of road users, divide motor vehicle traffic lanes when two or more lanes are kept open in the same direction, and to delineate the edge of a pavement drop off where space limitations do not allow the use of larger devices.

**Standard:**

**When a non-cylindrical tubular marker is used, it shall be attached to the pavement to ensure that the width facing road users meets the minimum requirements.**

**A tubular marker shall be attached to the pavement to display the minimum 2-inch width to the approaching road users.**

**7.14.3 VERTICAL PANELS****Standard:**

**Vertical panels shall be eight to 12 inches in width and at least 36 inches in height. They shall have orange and white diagonal stripes and be retroreflectorized.**

**Vertical panels shall be mounted with the top a minimum of 36 inches above the roadway, and a minimum of 42 inches above the pedestrian travel way. Vertical panels shall be mounted with the bottom no greater than 12 inch above the ground.**

**Where the height of the vertical panel itself is 36 inches or greater, a panel stripe width of six inches shall be used. Markings for vertical panels shall be alternating orange and white retroreflective stripes, sloping downward at an angle of 45 degrees in the direction the motor vehicle traffic is to pass. Vertical panels used on expressways, freeways, and other high-speed roadways shall have a minimum of 270 square inches retroreflective area facing motor vehicle traffic.**

**Option:**

Where space is limited, vertical panels may be used to channelize motor vehicle traffic, divide opposing lanes, or replace barricades when approved by the DDOT Engineer.

**7.14.4 DRUMS****Standard:**

**Drums used for road user warning or channelization shall be constructed of lightweight, deformable materials. They shall be a minimum of 36 inches in height and have at least an 18-inch minimum width regardless of orientation. Metal drums shall not be used. The markings on drums shall be horizontal, circumferential, alternating orange and white retroreflective stripes six inches wide. Each drum shall**

have a minimum of two orange and two white stripes with the top stripe being orange. Any nonretroreflectorized spaces between the horizontal orange and white stripes, shall not exceed three inches wide. Drums shall have closed tops that will not allow collection of construction debris or other debris.

Support:

Drums are highly visible, have good target value, give the appearance of being formidable obstacles and, therefore, command the respect of road users. They are portable enough to be shifted from place to place within a temporary traffic control zone in order to accommodate changing conditions but are generally used in situations where they will remain in place for a prolonged period of time.

Option:

Although drums are most commonly used to channelize or delineate road user flow, they may also be used alone or in groups to mark specific locations.

*Guidance:*

*Drums should not be weighted with sand, water, or any material to the extent that would make them hazardous to road users or workers when struck. Drums used in regions susceptible to freezing should have drain holes in the bottom so that water will not accumulate and freeze causing a hazard if struck by a road user.*

**Standard:**

**Ballast shall not be placed on the top of a drum.**

**Drums shall be used in all unmanned work zone locations and in all lane closure tapers on limited access highways for nighttime operations.**

#### **7.14.5 TYPE III BARRICADES**

Support:

A barricade is a portable or fixed device having three rails with appropriate markings and is used to control road users by closing or restricting all or a portion of the right-of-way.

**Standard:**

**Stripes on barricade rails shall be alternating orange and white retroreflective stripes sloping downward at an angle of 45 degrees in the direction road users are to pass.**

The minimum length for Type III Barricades shall be 48 inches. Each barricade rail shall be eight to 12 inches wide. Barricades used on expressways, freeways and other high-speed roadways shall have a minimum of 270 square-inches of retroreflective area facing road users.

*Guidance:*

*Where barricades extend entirely across a roadway, the stripes should slope downward in the direction toward which road users must turn.*

*Where both right and left turns are provided, the barricade stripes should slope downward in both directions from the center of the barricade or barricades (inverted V-shape).*

*Where no turns are intended, the stripes should be positioned to slope downward toward the center of the barricade or barricades (V-shape).*

*Barricade rails should be supported in a manner that will allow them to be seen by the road user and in a manner that provides a stable support that is not easily blown over or displaced.*

**Standard:**

**Barricades shall be crashworthy, as they are located adjacent to motor vehicle traffic flow and are subject to impact by errant vehicles from both the front and side directions.**

*Guidance:*

*On high-speed expressways or in other situations where barricades may be susceptible to overturning in the wind, ballasting should be used.*

Option:

Sandbags may be placed on the lower parts of the frame or the stays of barricades to provide the required ballast.

**Standard:**

**Ballast shall not be placed on top of any striped rail. Barricades shall not be ballasted by non-deformable objects such as rocks or chunks of concrete.**

*Guidance:*

*Type III Barricades should be used to close or partially close a road.*

Option:

Type III Barricades used at a road closure may be placed completely across a roadway or from curb to curb.

**Standard:**

**Where a provision is made for access of authorized equipment and vehicles, the responsibility for Type III Barricades shall be assigned to a person to ensure proper closure at the end of each work day.**

Support:

When a highway is legally closed but access must still be allowed for local road users, barricades usually are not extended completely across the roadway.

**Standard:**

**A sign (see earlier discussion in previous section) shall be installed with the appropriate legend concerning permissible use by local road users. Adequate visibility of the barricades from both directions shall be provided.**

Option:

Crashworthy signs may be installed on barricades (see earlier discussion in previous sections).

**7.14.6 DIRECTION INDICATOR BARRICADES**

**Standard:**

**Due to their proximity in appearance to a Type II barricade, the Direction Indicator Barricade shall not be used as a channelizing device.**

**7.14.7 TEMPORARY TRAFFIC BARRIERS AS CHANNELIZING DEVICES**

Support:

Temporary traffic barriers are not temporary traffic control devices in themselves; however, when placed in a position identical to a line of channelizing devices and marked and/or equipped with appropriate channelization features to provide guidance and warning both day and night, they serve as temporary traffic control devices.

**Standard:**

**Temporary traffic barriers serving as temporary traffic control devices shall conform to requirements for such devices as set forth throughout this manual.**

Temporary traffic barriers shall not be used solely to channelize road users, but also to protect the work space (see Section 6F.77 of the MUTCD). For nighttime use, the temporary traffic barrier shall be supplemented with delineation.

*Guidance:*

*Temporary traffic barriers should not be used for a merging taper except in low-speed urban areas. Temporary traffic barriers should not be used for a constricted/restricted temporary traffic control zone.*

*When it is necessary to use a temporary traffic barrier for a merging taper in low-speed urban areas or for a constricted/restricted temporary traffic control zone, the taper shall be delineated and the taper length should be designed to optimize road user operations considering the available geometric conditions*

*When used for channelization, temporary traffic barriers should be of a light color for increased visibility.*

#### **7.14.8 OTHER CHANNELIZING DEVICES**

**Standard:**

**Channelizing devices other than those described in this Manual shall require approval from DDOT Engineer or a review and/or engineering study prior to their use.**

*Guidance:*

*Other channelizing devices should conform to the general size, color, stripe pattern, retroreflection, and placement characteristics established for the devices described in this Manual.*

##### **7.14.8.1 TEMPORARY RAISED ISLANDS**

**Standard:**

**Temporary raised islands shall be used only in combination with pavement striping and other suitable channelizing devices.**

Option:

A temporary raised island may be used to separate motor vehicle traffic flows in two-lane, two-way operations on roadways having a motor vehicle traffic volume range of 4,000 to 15,000 average daily traffic (ADT) and on freeways having a motor vehicle traffic volume range of 22,000 ADT to 60,000 ADT.

Temporary raised islands also may be used in other than two-lane, two-way operations where physical separation of motor vehicle traffic from the temporary traffic control zone is not required.

*Guidance:*

*Temporary raised islands should have the basic dimensions of four inches in height by 15 to 18 inches in width and have rounded or chamfered corners.*

*The temporary raised islands should not be designed in such a manner that they would cause a motorist to lose control of the vehicle if the vehicle inadvertently strikes the temporary raised island. If struck, pieces of the island should not be dislodged to the extent that they could penetrate the occupant compartment or involve other vehicles.*

*Orange flexible post delineators 36 inches in height and 2.25 to four inches in width should be placed on top of the raised island for delineation.*

**Standard:**

**Flexible post delineators shall be spaced every 80 feet, with a temporary pavement marker spaced in between each delineator on top of the temporary raised median. Retro-reflective sheeting shall be placed three inches from the top of each flexible post delineator.**

**7.14.8.2 PAVEMENT MARKINGS**

**Standard:**

**The provisions of this Section shall not be considered applicable for short-term, mobile, or incident management temporary traffic control zones.**

**Pavement markings shall be maintained along paved streets and highways in all long- and intermediate-term stationary temporary traffic control zones. All pavement markings shall be in accordance with Chapters 3A and 3B of the MUTCD, except as indicated in previous sections of this manual. Pavement markings shall match the markings in place at both ends of the temporary traffic control zone. Pavement markings shall be placed along the entire length of any surfaced detour or temporary roadway prior to the detour or roadway being opened to road users.**

**Warning signs, channelizing devices and delineation shall be used to indicate required road user paths in temporary traffic control zones where it is not possible to provide a clear path by pavement markings. All pavement markings and devices used to delineate road user paths shall be carefully reviewed during daytime and nighttime periods.**

For long-term stationary operations, pavement markings in the temporary traveled way that are no longer applicable shall be removed or obliterated as soon as practical.

Pavement marking obliteration shall leave a minimum of pavement scars and shall remove old marking material. Painting over existing pavement markings with black paint or spraying with asphalt shall not be accepted as a substitute for removal or obliteration.

*Guidance:*

*Road users should be provided pavement markings within a temporary traffic control zone comparable to the pavement markings normally maintained along such roadways, particularly at either end of the temporary traffic control zone.*

*The intended vehicle path should be defined in day, night, and twilight periods under both wet and dry pavement conditions.*

*The work should be planned and staged to provide for the placement and removal of the pavement markings. Markings should be provided in intermediate-term, stationary work zones.*

Option:

Removable, nonreflective, preformed tape may be used where markings need to be covered temporarily.

### **7.14.8.3 TEMPORARY PAVEMENT MARKINGS**

**Support:**

Temporary pavement markings are those that are allowed to remain in place until the earliest date when it is practical and possible to install pavement markings that meet the MUTCD Part 3 standards for pavement markings.

*Guidance:*

*Temporary pavement markings should not be in place for more than two weeks unless justified by an engineering study.*

**Standard:**

**All temporary pavement markings, including pavement markings for no-passing zones, shall conform to the requirements of Chapters 3A and 3B of the MUTCD. All temporary broken-line pavement markings shall use the same cycle length as permanent markings and be at least two feet long.**



Option:

Half-cycle lengths with a minimum of 2-foot stripes may be used on roadways with severe curvature (see Section 3A.06 of the MUTCD). This applies to centerlines in passing zones and lane lines.

For temporary situations of three calendar days or less, for a 2- or 3-lane road, no-passing zones may be identified by using “NO PASSING ZONE” (W14-3) signs rather than pavement markings. Also, “NO PASSING ZONE” signs may be used instead of pavement markings on low-volume roads (as defined in Section 5A.01 of the MUTCD) for longer periods in accordance with the District’s policy.

*Guidance:*

*The NO PASSING ZONE signs should be placed in accordance with Sections 2B.24, 2B.25, and 2C.32 of the MUTCD.*

*The temporary use of edge lines, channelizing lines, lane reduction transitions, gore markings, and other longitudinal markings, and the various non-longitudinal markings (such as stop lines, railroad crossings, crosswalks, words or symbols) should be in accordance with the District’s policy.*

**7.14.8.4 RAISED PAVEMENT MARKERS**

**Standard:**

**Temporary pavement markers shall be installed with construction pavement markings, except non-retroreflective removable markings, in transition (lane drop) or lane shift areas of work zones which will encroach upon the traveled way for a period of more than three days and in other areas as required by the Engineer. Temporary pavement markers shall be installed on 20-foot centers in lane shift and transition areas. When temporary pavement markers are used in other areas, they shall be installed on 40-foot centers unless otherwise required by the Engineer.**

**7.14.8.5 DELINEATORS**

**Standard:**

**When used, delineators shall combine with or supplement other temporary traffic control devices. They shall be mounted on crashworthy supports so that the reflecting unit is approximately four feet above the near roadway edge. The standard color for delineators used along both sides of two-way streets and highways and the right side of one-way roadways shall be white. Delineators used along the left side of one way roadways shall be yellow.**

*Guidance:*

*Spacing along roadway curves should be as set forth in the MUTCD and should be such that several delineators are always visible to the motorist.*

Option:

Delineators may be used in temporary traffic control zones to indicate the alignment of the roadway and to outline the required vehicle path through the temporary traffic control zone.

## **7.15 LIGHTING DEVICES**

*Guidance:*

*Lighting devices should be provided in temporary traffic control zones based on engineering judgment.*

Support:

Four types of lighting devices are commonly used in temporary traffic control zones. They are floodlights, flashing warning beacons, warning lights, and steady-burn electric lamps.

Option:

Lighting devices may be used to supplement retroreflectorized signs, barriers, and channelizing devices.

Support:

During normal daytime maintenance operations, the functions of flashing warning beacons are adequately provided by rotating lights or strobe lights on a maintenance vehicle.

**Standard:**

**Although vehicle hazard warning lights are permitted to be used to supplement rotating or strobe lights, they shall not be used instead of rotating or strobe lights.**

### **7.15.1 FLOODLIGHTS**

Support:

Utility, maintenance, or construction activities on highways are frequently conducted during nighttime periods when motor vehicle traffic volumes are lower. Large

construction projects are sometimes operated on a double-shift basis requiring night work.

*Guidance:*

*When nighttime work is being performed, floodlights should be used to illuminate the work area, flagger stations, equipment crossings, and other areas.*

**Standard:**

**Floodlighting shall not produce a disabling glare condition for approaching road users.**

**The adequacy of the floodlight placement and elimination of potential glare shall be determined by driving through and observing the floodlighted area from each direction on all approaching roadways after the initial floodlight setup, at night, and periodically during each shift.**

Support:

Research indicates that five feet candles are a desirable nighttime illumination level where workers are active.

#### **7.15.2 FLASHING WARNING BEACONS**

Support:

Flashing warning beacons are often used to supplement a temporary control device.

**Standard:**

**Flashing warning beacons shall comply with the provisions of Chapter 4K of the MUTCD. A flashing warning beacon shall be a flashing yellow light with a minimum nominal diameter of eight inches.**

*Guidance:*

*Flashing warning beacons should be operated 24 hours per day.*

Support:

The temporary terminus of a freeway is an example of a location where flashing warning beacons alert motorists to the changing roadway conditions and the need to reduce speed in transitioning from the freeway to another roadway type.

### 7.15.3 WARNING LIGHTS

**Standard:**

**Type A, Type B, Type C, and Type D 360-degree warning lights are portable, powered, yellow, lens-directed, enclosed lights.**

**Warning lights shall be in accordance with the current ITE "Purchase Specification for Flashing and Steady-Burn Warning Lights."**

**When warning lights are used, they shall be mounted on signs or channelizing devices in a manner that, if hit by an errant vehicle, they will not be likely to penetrate the windshield.**

*Guidance:*

*The maximum spacing for warning lights should be identical to the channelizing device spacing requirements.*

**Support:**

The lightweight and portability of warning lights are advantages that make these devices useful as supplements to the retroreflectorization on signs and channelizing devices. The flashing lights are effective in attracting road users' attention.

Option:

Warning lights may be used in either a steady-burn or flashing mode.

**Standard:**

**Flashing warning lights shall not be used for delineation, as a series of flashers fails to identify the desired vehicle path.**

**Type A Low-Intensity Flashing warning lights, Type C Steady-Burn warning lights, and Type D 360-degree Steady-Burn warning lights shall be maintained so as to be capable of being visible on a clear night from a distance of 3,000 feet. Type B High-Intensity Flashing warning lights shall be maintained so as to be capable of being visible on a sunny day when viewed without the sun directly on or behind the device from a distance of 1,000 feet.**

**Warning lights shall have a minimum mounting height of 30 inches to the bottom of the lens.**

Support:

Type A Low-Intensity Flashing warning lights are used to warn road users during nighttime hours that they are approaching or proceeding in a potentially hazardous area.

Option:

Type A warning lights may be mounted on channelizing devices.

Support:

Type B High-Intensity Flashing warning lights are used to warn road users during both daylight and nighttime hours that they are approaching a potentially hazardous area.

Option:

Type B warning lights are designed to operate 24 hours per day and may be mounted on advance warning signs or on independent supports. Type C Steady-Burn warning lights may be used during nighttime hours to delineate the edge of the traveled way.

*Guidance:*

*When used to delineate a curve, Type C and Type D 360-degree Steady-Burn warning lights should only be used on devices on the outside of the curve, and not on the inside of the curve.*

#### **7.15.4 STEADY-BURN ELECTRIC LAMPS**

Support:

Steady-Burn electric lamps are a series of low-wattage, yellow, electric lamps, generally hard-wired to a 110-volt external power source.

Option:

Steady-Burn electric lamps may be used in place of Type C Steady-Burn warning lights.

#### **7.15.5 VEHICLE WARNING LIGHTS**

*Guidance:*

*Warning lights on vehicles should be mounted so as to be viewed 360 degrees on vehicles without arrow panels and 180 degrees on vehicles with arrow panels.*

**Standard:**

**Vehicle warning lights shall be either a rotating amber light or a high intensity amber strobe light and meet the following conditions:**

- A. Rotating amber lights shall consist of a minimum of two halogen sealed beams enclosed within an amber colored dome. Sealed beams shall be at least 60,000 Candlepower and shall have a flash rate of 80 to 100 flashes per minute. Rotating lights shall be approximately 8½ inches or greater in diameter and height (six inches in height for multi-light bars). Rotating lights shall be mounted so as to be viewed 360 degrees; double lights may be used to achieve 360 degree viewing.**
- B. High intensity amber strobe lights shall consist of a double flash unit enclosed within an amber colored lens. Flash rate shall be 80±10 flashes per minute. Strobe lights shall be approximately six inches in diameter and 7½ inches in height or greater. Strobe lights shall be mounted so as to be viewed 360 degrees; double lights may be used to achieve 360 degree viewing.**

*Guidance:*

*During night operations, vehicles entering and exiting the work area should be equipped with and have operating at least one rotating amber light or high intensity amber strobe light.*

#### **7.16 TEMPORARY TRAFFIC CONTROL SIGNALS**

**Standard:**

**Temporary traffic control signals used to control road user movements through temporary traffic control zones and in other temporary traffic control situations shall meet the applicable provisions of Part 4 of the MUTCD.**

Support:

Temporary traffic control signals are typically used in work zones such as temporary haul road crossings; temporary one-way operations along a one-lane, two-way highway; temporary one-way operations on bridges, reversible lanes, and intersections.

**Standard:**

**One-lane, two-way motor vehicle traffic flow (see Chapter 4G of the MUTCD) requires all-red interval of sufficient duration for road users to clear the portion of the temporary traffic control zone controlled by the traffic control signals. Safeguards shall be incorporated to avoid the possibility of conflicting signal indications at each end of the temporary traffic control zone. All equipment shall be in compliance with the current national standard and in excellent working condition.**

*Guidance:*

*When temporary traffic control signals are used, conflict monitors typical of traditional traffic control signal operations should be used.*

**Standard:**

**The DDOT Engineer shall determine which traffic control signal will be used – portable or temporarily mounted on fixed supports.**

Option:

Temporary traffic control signals may be portable or temporarily mounted on fixed supports.

*Guidance:*

*Temporary traffic control signals should only be used in situations where temporary traffic control signals are preferable to other means of traffic control, such as changing the work staging or work zone size to eliminate one-way motor vehicle traffic movements, using flaggers to control one-way or crossing movements, using STOP or YIELD signs, and using warning devices alone.*

*Temporary traffic control signals not in use should be covered or removed.*

### **7.17 TEMPORARY TRAFFIC BARRIERS**

**Support:**

Temporary traffic barriers are devices designed to help prevent penetration by vehicles while minimizing injuries to vehicle occupants and designed to protect workers, bicyclists, and pedestrians.

The four primary functions of temporary traffic barriers are:

1. To keep vehicular traffic from entering work areas, such as excavations or material storage sites
2. To separate workers, bicyclists, and pedestrians from vehicular traffic
3. To separate opposing directions of vehicular traffic
4. To separate vehicular traffic, bicyclists, and pedestrians from the work area such as false work for bridges and other exposed objects

**Option:**

Temporary traffic barriers, including shifting portable or movable barrier installations to accommodate varying directional motor vehicle traffic demands, may be used to separate two-way motor vehicle traffic.

**Guidance:**

*Because the protective requirements of a temporary traffic control situation have priority in determining the need for temporary traffic barriers, their use should be based on an engineering study. When serving the additional function of channelizing motor vehicle traffic, temporary traffic barriers should be a light color for increased visibility.*

**Standard:**

**Temporary traffic barriers shall be supplemented with standard delineation, pavement markings, or channelizing devices for improved daytime and nighttime visibility if they are used to channelize motor vehicle traffic. The delineation or pavement marking color shall match the applicable pavement marking color.**

**When serving the additional function of channelizing traffic, portable barriers should be of a light color for increased visibility. More specific information on the use and design of portable barriers and impact attenuators can be obtained from Chapters 8 and 9, respectively, of the AASHTO *Roadside Design Guide*. For nighttime visibility, barriers shall be supplemented with delineators, barrier vertical panels, and a flashing light.**

**Barrier vertical panels eight inches in width and 12 inches in height shall be installed on top of the barrier. Panels shall be installed on 48-foot centers in the transition or taper sections and on 96-foot centers in the tangent sections. A Type A flashing light shall be installed on the barrier at the breakpoint where the transition or taper ends and the barrier becomes parallel to the roadway. Barrier vertical panels shall have a fluorescent orange retroreflective surface in the direction of oncoming traffic.**

**The effect of striking the ends of barriers shall be mitigated by use of impact attenuators or by flaring the ends of barriers away from the traveled way. Following in the order of preference are the methods to be used in mitigating the effect of striking the ends of barriers:**

- A. Where a guardrail exists, the guardrail shall be attached to the barrier with the appropriate fixed object attachment.**
- B. Where a cut slope exists, the barrier shall be buried into the cut slope. Drainage shall be provided as needed.**
- C. Extend end of barrier until it is beyond the established Clear Zone.**



- D. When the barrier end is inside the desired Clear Zone, attenuator service Type I or Type II (Sand Barrels) shall be used. Refer to Special Design Drawings for type and quantity needed for each location.**

Support:

A movable barrier is a linear system of connected barrier segments that can rapidly be shifted laterally by using a specially designed transfer vehicle. The transfer is accomplished in a manner that does not interfere with motor vehicle traffic in adjacent lanes. Applications of movable barriers include the following:

1. Closing an additional lane during work periods while maintaining the advantage of having the travel way separated from the work space by a barrier
2. Closing an additional lane during off-peak periods to provide extra space for work activities without adversely impacting motor vehicle traffic flow
3. Creating a temporary reversible lane, thus providing unbalanced capacity favoring the major direction of motor vehicle traffic flow

More specific information on the use of temporary traffic barriers is contained in Chapters 8 and 9 of the AASHTO *Roadside Design Guide*.

### **7.18 CRASH CUSHIONS**

Support:

Crash cushions are systems that mitigate the effects of errant vehicles that strike obstacles, either by smoothly decelerating the vehicle to a stop when hit head-on or by redirecting the errant vehicle. The two types of crash cushions that are used in temporary traffic control zones are stationary crash cushions and truck-mounted attenuators. Crash cushions in temporary traffic control zones help protect the motorist from the exposed ends of barriers, fixed objects, shadow vehicles, and other obstacles. Specific information on the use of crash cushions can be found in the AASHTO *Roadside Design Guide*.

**Standard:**

**Crash cushions shall be crashworthy conforming to the requirements of National Cooperative Highway Research Program (NCHRP) Report 350, except as otherwise indicated herein. They shall also be designed for each application to stop or redirect errant vehicles under prescribed conditions.**

**Crash cushions shall be periodically inspected to verify that they have not been hit or damaged. Damaged crash cushions shall be promptly repaired or replaced to maintain their crashworthiness.**

Support:

Stationary crash cushions are used in the same manner as permanent highway installations to protect motorists from the exposed ends of barriers, fixed objects, and other obstacles.

**Standard:**

**Stationary crash cushions shall be designed for the specific application intended.**

**Truck-mounted attenuators (TMA) shall be energy-absorbing devices attached to the rear of shadow trucks when conditions warrant.**

Support:

Trucks are often used as shadow vehicles to protect workers or work equipment from errant vehicles.

These shadow vehicles are normally equipped with flashing arrows, changeable message signs, and/or rotating/strobe lights located properly in advance of the workers and/or equipment that they are protecting. However, these shadow vehicles might themselves cause injuries to occupants of the errant vehicles if they are not equipped with truck-mounted attenuators. The most effective placement of the shadow vehicle is in advance of the first work crew, equipment, or hazard the traveling motorist would encounter.

**Standard:**

**Shadow trucks with TMA shall be used:**

- A. When closing a lane on a four or more lane roadway with a posted speed of 40 mph or greater**
- B. On ramps and loops of interstate and limited access highways**
- C. When a mobile operation occupies all or part of the travel lane on a multi-lane roadway with a posted speed of 40 mph or greater**
- D. Other locations where Traffic Services Administration feels such protection is warranted**

**TMA units used on all Limited Access highways, as well as on all four or more lane primary roadways with posted speeds of 45 mph or greater, shall be NCHRP 350, Test Level 3 units. On July 1, 2005, all TMA units shall conform to the requirements of NCHRP 350, Test Level 3 regardless of where the units will be used.**

**The shadow truck with a TMA shall be positioned a sufficient distance (50 to 100 feet) in advance of the workers or equipment being protected to allow for**

**appropriate vehicle roll-ahead but not so far that errant vehicles will travel around the vehicle and strike the protected workers and/or equipment.**

**When all work crews, equipment, or hazards have been sufficiently removed from the lane closure, the shadow truck shall be removed.**

Support:

Shadow trucks should be used when installing and removing lane closures from the roadway. In mobile operations, the shadow truck with a truck-mounted attenuator should be 1,000 feet in advance of the work vehicle.

Option:

Shadow trucks with TMA may be eliminated when their use would destroy or damage uncured asphalt.

For additional operations or hazards located further downstream from the taper, a shadow vehicle without a truck-mounted attenuator may be used for protection, placed a sufficient distance (50 to 100 feet) in advance of the hazard.

Support:

Asphalt pavement resurfacing operations are typically those instances where shadow trucks with TMA would destroy or damage uncured asphalt. Other operations being accomplished under the same project would still require the use of TMA if their use would not destroy or damage the uncured asphalt.

Examples of those operations include shoulder work where the adjacent lane is required to be closed, pavement marking applications (except pavement marking tape being inlaid into the new asphalt surface), and other similar type operations.

**Standard:**

**During operation as a shadow vehicle with a TMA, the truck shall not be used as a work operations vehicle. All material and/or equipment on the shadow vehicle TMA shall be properly secured to prevent spillage if struck by an errant vehicle.**

*Guidance:*

*The attenuator should be in the full down-and-locked position when in use. For stationary operations, the truck's parking brake should be set and the front wheels positioned straight ahead.*

Support:

Chapter 9 of the AASHTO *Roadside Design Guide* contains additional information regarding the use of shadow vehicles with TMA.

**Standard:**

**The TMA shall be used in accordance with the manufacturer's specifications.**

### **7.19 VEHICLE-ARRESTING SYSTEMS**

Support:

Vehicle-arresting systems are designed to prevent penetration into activity areas while providing for smooth, safe deceleration for the errant vehicles. They can consist of portable netting, cables, and energy-absorbing anchors.

*Guidance:*

*When used, a vehicle-arresting system should be used in accordance with the manufacturer's specifications and should be located so that vehicles are not likely to penetrate the location that the system is designed to protect.*

### **7.20 RUMBLE STRIPS**

Support:

Transverse rumble strips consist of intermittent narrow, transverse areas of rough-textured or slightly raised or depressed road surface that extend across the travel lanes to alert motorists to unusual vehicular traffic conditions. Through noise and vibration they attract the motorist's attention to such features as unexpected changes in alignment and to conditions requiring a stop.

Longitudinal rumble strips consist of a series of rough-textured or slightly raised or depressed road surfaces located along the shoulder to alert road users that they are leaving the travel lanes.

Option:

Intervals between transverse rumble strips may be reduced as the distance to the approached conditions is diminished in order to convey an impression that a closure speed is too fast and/or that an action is imminent. A sign warning motorists of the onset of rumble strips may be placed in advance of any rumble strip installation.

*Guidance:*

*Transverse rumble strips should be placed transverse to vehicular traffic movement. They should not adversely affect overall pavement skid resistance under wet or dry conditions.*

*In urban commercial areas, even though a closer spacing might be warranted, transverse rumble strips should be designed in a manner that does not promote panic braking or erratic steering maneuvers by road users.*

*Transverse rumble strips should not be placed on sharp horizontal or vertical curves. Rumble strips should not be placed through pedestrian crossings or bicycle routes.*

## **7.21 SCREENS**

Support:

Screens are used to block the road users' view of activities that can be distracting. Screens might improve safety and motor vehicle traffic flow where volumes approach the roadway capacity because they discourage gawking and reduce headlight glare from oncoming motor vehicle traffic.

*Guidance:*

*Screens should not be mounted where they could adversely restrict motorist visibility and sight distance and adversely affect the safe operation of vehicles.*

*Screens should be mounted on the top of temporary traffic barriers that separate two-way motor vehicle traffic, especially in crossover areas.*

*Design of screens should be in accordance with Chapter 9 of the AASHTO Roadside Design Guide.*

## **7.22 FUTURE AND EXPERIMENTAL DEVICES**

Support:

The District of Columbia, as well as other States, FHWA, AASHTO, the Transportation Research Board, and other organizations conduct research and experimentation on new traffic control and safety devices. Users of this Manual are encouraged to stay abreast of these current efforts and to use such devices with care so as to avoid presenting road users with unusual or confusing situations that might be abnormal or unexpected.

**Standard:**

**New traffic control devices shall conform to the provisions for design, use, and application set forth in this Manual. New traffic control devices that do not conform to the provisions in this Manual shall be subject to experimentation, documentation, and adoption following the provisions of Section 1A.10 of the MUTCD.**

**Approval shall be obtained from the Associate Director of TSA in the District Department of Transportation for new traffic control devices prior to their use and/or implementation.**



## **SECTION 8 - TYPE OF TEMPORARY TRAFFIC CONTROL ZONE ACTIVITIES**

### **8.1 TYPICAL APPLICATIONS**

Support:

Each temporary traffic control zone is different. Many variables, such as location of work, road type, geometrics, vertical and horizontal alignment, intersections, interchanges, road user volumes, road vehicle mix (buses, trucks, and cars), and road user speeds affect the needs of each zone. The goal of temporary traffic control in work zones is safety with minimum disruption to road users. The key factor in promoting temporary traffic control zone safety is proper judgment.

*Guidance:*

*Typical traffic control figures should be altered, when necessary, to fit the conditions of a particular temporary traffic control zone. The alteration should be documented.*

Option:

Other devices may be added to supplement the devices shown in the typical traffic control figures, while others may be deleted. The sign spacing and taper lengths may be increased to provide additional time or space for motorist response.

Support:

Decisions regarding the selection of the most appropriate typical traffic control figure to use as a guide for a specific temporary traffic control zone require an understanding of each situation. Although there are many ways of categorizing work zone applications, the four factors mentioned earlier (work duration, work location, work type, and highway type) are used to characterize the typical traffic control figures illustrated in this manual.

### **8.2 WORK DURATION**

Support:

Work duration is a major factor in determining the number and types of devices used in temporary traffic control zones. The duration of a temporary traffic control zone is defined relative to the length of time a work operation occupies a spot location.



**Standard:**

The four categories of work duration and their time at a location shall be:

1. **Mobile Operation** – an operation that moves intermittently and will not occupy the immediate area for more than five minutes. The immediate area is defined as a 1,000± linear foot distance.
2. **Short-Duration** – an operation that occupies a location between six and 15 minutes.
3. **Moderate-Duration** – an operation that occupies a location between 16 and 60 minutes.
4. **Stationary** – an operation that occupies a location for more than 60 minutes.
  - a. **Short-Term** – Daytime work lasting between one and 12 hours.
  - b. **Intermediate-Term** – Work that occupies a location from overnight to three days.
  - c. **Long-Term** – Work that occupies a location for a period of greater than three days.

**Note:**

**For short-term and intermediate-term work duration, spring loaded sign mounts and traffic drums shall be used. For long-term work duration, post mounted signs and portable concrete barriers shall be used.**

**Support:**

At long-term stationary temporary traffic control zones, there is ample time to install and realize benefits from the full range of temporary traffic control procedures and devices that are available for use. Generally, an increased number of channelizing devices, temporary roadways, and temporary traffic barriers are used.

**Standard:**

**Since intermediate-term and long-term operations extend into nighttime, retroreflective and/or illuminated devices shall be used in long-term stationary temporary traffic control zones. Group 2 channelizing devices shall be used in place of cones when the work crew is not present to align displaced or overturned devices.**

*Guidance:*

*Inappropriate pavement markings in long-term stationary temporary traffic control zones should be removed and replaced with temporary markings.*

Support:

In intermediate-term stationary temporary traffic control zones, it may not be feasible or practical to use procedures or devices that would be desirable for long-term stationary temporary traffic control zones, such as altered pavement markings, temporary traffic barriers, and temporary roadways. The increased time to place and remove these devices in some cases could significantly lengthen the project, thus increasing exposure time. In other instances, there might be insufficient pay-back time to economically justify more elaborate temporary traffic control measures.

**Standard:**

**Since intermediate-term operations extend into nighttime, retroreflective and/or illuminated devices shall be used in intermediate-term stationary temporary traffic control zones. Group 2 channelizing devices shall be used in place of cones when the work crew is not present to align displaced or overturned devices.**

Support:

Most maintenance and utility operations are short-term stationary work or less. As compared to stationary operations, mobile operations, short-duration operations, and moderate duration operations are activities that might involve different treatments. Devices having greater mobility might be necessary, such as signs mounted on trucks and use of portable changeable message signs. Devices that are larger, more imposing, or more visible can be used effectively and economically. The mobility of the temporary traffic control zone is important. Maintaining safe work and road user conditions is a paramount goal in carrying out mobile operations.

*Guidance:*

*Safety in moderate-duration, short-duration, or mobile operations should not be compromised by using fewer devices simply because the operation will frequently change its location.*

Option:

Appropriately colored or marked vehicles with rotating/strobe lights, and augmented with signs or arrow panels may be used in place of static signs and channelizing devices for moderate-duration, short-duration, or mobile operations.

Support:

During short-duration work, it often takes longer to set up and remove the temporary traffic control zone than to perform the work. Workers face hazards in setting up and taking down the temporary traffic control zone. Also, since the work time is short, delays affecting road users are significantly increased when additional devices are installed and removed.

Option:

Considering these factors, simplified control procedures may be warranted for short-duration work. A reduction in the number of devices may be offset by the use of other more dominant devices such as rotating lights or strobe lights on work vehicles.

Support:

Mobile or short-duration operations often involve frequent short stops, each less than 15 minutes, for activities such as litter cleanup, pothole patching, or utility operations, and are similar to short-duration operations.

*Guidance:*

*Warning signs, rotating/strobe lights on a vehicle, and/or channelizing devices should be used and moved periodically to keep them near the mobile work area.*

Option:

Flaggers may also be used for mobile or short-duration operations.

Support:

Mobile operations also include work activities where workers and equipment move along the road without stopping, usually at slow speeds. The advance warning area moves with the work area.

*Guidance:*

*When mobile operations are being performed, a shadow vehicle equipped with an arrow panel or a sign should follow the work vehicle, especially when motor vehicle traffic speeds or volumes are high. Where feasible, warning signs should be placed along the roadway and moved periodically as work progresses. Under high-volume conditions, consideration should be given to scheduling mobile operations work during off-peak hours.*

**Standard:**

**If there are mobile operations on a high-speed travel lane of a multilane divided highway, arrow panels shall be used. Additionally, if posted speeds are 45 mph or greater, a TMA shall be used on the shadow vehicle(s).**

Option:

For mobile operations that move at speeds less than three mph, mobile signs or stationary signing that is periodically retrieved and repositioned in the advance warning area may be used. At higher speeds, vehicles may be used as components of temporary traffic control

zones for mobile operations. Appropriately colored and marked vehicles with signs, rotating/strobe lights, truck-mounted attenuators, and arrow panels or portable changeable message signs may follow a train of moving work vehicles.

For some continuously moving operations, such as street cleaning and snow removal, a single work vehicle with appropriate warning devices on the vehicle may be used to provide warning to approaching road users.

**Standard:**

**Mobile operations that move at speeds greater than 20 mph, such as pavement marking operations, shall have appropriate devices on the equipment (rotating lights, signs, or special lighting) or shall use a separate vehicle with appropriate warning devices.**

**8.3 LOCATION OF WORK AND ROADWAY CHARACTERISTICS**

Support:

The choice of temporary traffic control needed for a temporary traffic control zone depends upon where the work is located and the roadway characteristics. As a general rule, the closer the work is to road users, the greater the number of temporary traffic control devices needed. Procedures are described later in this Section for establishing temporary traffic control zones in the following locations:

- A. Outside the shoulder
- B. On the shoulder with no encroachment
- C. On the shoulder with minor encroachment
- D. Within the median
- E. Within the traveled way

**Standard:**

**When the work space is within the traveled way, except for mobile operations, advance warning shall provide a general message that work is taking place, shall supply information about highway conditions, and shall indicate how motor vehicle traffic can move through the temporary traffic control zone.**

## **8.4 MODIFICATIONS TO FULFILL SPECIAL NEEDS**

### **Support:**

The typical application figures in Section 9 illustrate commonly-encountered situations in which temporary traffic control devices are employed. Roadway characteristics to consider in selecting the appropriate temporary traffic control figure also include travel speeds and traffic volumes. The definition of a high-speed roadway is prevailing speeds of 45 mph and greater; and a low speed roadway has speeds of less than 45 mph. High volume roadways have an average daily traffic (ADT) of 500 or more vehicles per day, while low volume roadways have less than 500 vehicles per day.

### **Option:**

Other devices may be added to supplement the devices indicated in the typical traffic control figures, and device spacing may be adjusted to provide additional reaction time. When conditions are less complex than those depicted in the typical traffic control figures, fewer devices may be needed.

### ***Guidance:***

*When conditions are more complex, typical application figures should be modified by incorporating appropriate devices and practices from the following list:*

#### *A. Additional devices:*

- 1. Signs*
- 2. Arrow panels*
- 3. More channelizing devices at closer spacing*
- 4. Temporary raised pavement markers*
- 5. High-level warning devices*
- 6. Portable changeable message signs*
- 7. Temporary traffic signals*
- 8. Temporary traffic barriers*
- 9. Crash cushions*
- 10. Screens*
- 11. Rumble strips*
- 12. More delineation*

*B. Upgrading of devices:*

- 1. A full complement of standard pavement markings*
- 2. Brighter and/or wider pavement markings*
- 3. Larger and/or brighter signs*
- 4. Channelizing devices with greater conspicuity*
- 5. Temporary traffic barriers in place of channelizing devices*

*C. Improved geometrics at detours or crossovers, giving particular attention to the provisions set forth in Section 3 – Fundamental Principles*

*D. Increased distances:*

- 1. Longer advance warning area*
- 2. Longer tapers*

*E. Lighting:*

- 1. Temporary roadway lighting*
- 2. Steady-burn lights used with channelizing devices*
- 3. Flashing lights for isolated hazards*
- 4. Illuminated signs*
- 5. Floodlights*

**Support:**

Uniformity of devices and their application is always of paramount importance. As noted earlier, temporary traffic barriers are not temporary traffic control devices in themselves; however, when placed in a position identical to a line of channelizing devices and marked and equipped with appropriate channelization features to provide guidance and warning both day and night, they serve as temporary traffic control devices.

**Standard:**

**Temporary traffic barriers serving as temporary traffic control devices shall conform to requirements for such devices as set forth throughout this manual.**

## **8.5 WORK OFF OF THE ROADWAY**

**Support:**

When work is being performed off of the roadway (beyond the shoulders, but within the right-of-way), little temporary traffic control may be needed. Temporary traffic control generally is not needed where work is confined to an area 30 feet or more from the edge

of the traveled way and out of the clear zone. However, temporary traffic control is appropriate where distracting situations exist, such as vehicles parked on the shoulder, vehicles accessing the work site via the highway, and equipment traveling on or crossing the roadway to perform the work operations (for example, mowing). A typical application is shown in Figure 6H-1 of the MUTCD.

*Guidance:*

*Where the above situations exist, a single warning sign, such as “ROAD WORK AHEAD,” should be used. If the equipment travels on the roadway, the equipment should be equipped with appropriate flags, rotating/strobe lights, and/or a SLOW MOVING VEHICLE symbol. If work vehicles or equipment are on the shoulder, a “SHOULDER WORK AHEAD” sign should be used. For mowing operations, the signs “MOWING AHEAD” and “WATCH FOR SLOW MOVING VEHICLES” should be used.*

Option:

Where the activity is spread out over a distance of more than two miles, the “SHOULDER WORK AHEAD” sign may be repeated every one mile. A supplementary plaque with the message “NEXT X MILES” may be used.

*Guidance:*

*A general warning sign like “ROAD MACHINERY AHEAD” should be used if workers and equipment must occasionally move closer to the traveled way.*

## 8.6 WORK ON THE SHOULDER WITH NO ENCROACHMENT

Support:

The provisions of this Section apply to short-term through long-term stationary operations.

**Standard:**

**When paved shoulders having a width of eight feet or more are closed, at least one advance warning sign shall be used. In addition, channelizing devices shall be used to close the shoulder in advance to delineate the beginning of the work space and direct motor vehicle traffic to remain within the traveled way.**

*Guidance:*

*When a highway shoulder is occupied, a “SHOULDER WORK AHEAD” sign, except for short-duration and mobile operations, should be placed in advance of the activity area. When work is performed on a paved shoulder eight feet or more in width, channelizing devices should be placed on a taper having a length that conforms to the requirements of a shoulder taper.*

*When paved shoulders having a width of eight feet or more are closed on expressways and freeways, road users should be warned about potential disabled vehicles that cannot get off the traveled way. An initial general warning sign (such as “ROAD WORK AHEAD”) should be used, followed by a “RIGHT” or “LEFT SHOULDER CLOSED AHEAD” sign. Where the end of the shoulder closure extends beyond the distance which can be perceived by road users, a supplementary plaque bearing the message “NEXT XX FEET” or “MILES” or “BLOCKS” as per the functional classification of the road or as deemed necessary by DDOT Engineer should be placed below the “SHOULDER CLOSED AHEAD” sign. On multilane, divided highways, signs advising of shoulder work or the condition of the shoulder should be placed only on the side of the affected shoulder.*

*When an improved shoulder is closed on a high-speed roadway, it should be treated as a closure of a portion of the road system because road users expect to be able to use it in emergencies. Road users should be given ample advance warning that shoulders are closed for use as refuge areas throughout a specified length of the approaching temporary traffic control zone. The sign(s) should read “SHOULDER CLOSED AHEAD” with distances indicated. The work space on the shoulder should be closed off by a taper or by channelizing devices with a length of  $0.33 L$ ; where  $L$  is the taper length as determined using the formulas in Table 4-2.*

*When the shoulder is not occupied but work has adversely affected its condition, the “LOW SHOULDER” or “SOFT SHOULDER” sign should be used, as appropriate. Where the condition extends over a distance in excess of one mile, the sign should be repeated at one mile intervals.*

**Option:**

In addition, a supplementary plaque bearing the message “NEXT X MILES” OR “NEXT XX FEET” OR “XX BLOCKS,” as per the functional classification of the road or as deemed necessary by DDOT Engineer, may be used. Temporary traffic barriers may be needed to inhibit encroachment of errant vehicles into the work space and to protect workers.

**Standard:**

**When used for shoulder work, arrow panels shall operate in the four-corner caution mode only.**

**Support:**

A typical traffic control figure for stationary work operations on shoulders is shown in Figure 6H-3 of the MUTCD. Short-duration or mobile work on shoulders is shown in Figure 6H-4 of the MUTCD. Work on freeway shoulders is shown in Figure 6H-5 of the MUTCD.



## **8.7 WORK ON THE SHOULDER WITH MINOR ENCROACHMENT**

### *Guidance:*

*When work takes up part of a lane, motor vehicle traffic volumes, vehicle mix (buses, trucks, and cars), speed, and capacity should be analyzed to determine whether the affected lane should be closed. Unless the lane encroachment permits a remaining lane width of 11 feet, the lane should be closed. Truck off-tracking should be considered when determining whether the minimum lane width of 10 feet is adequate when working on exit ramps.*

### Option:

A lane width of 10 feet may be used for short-term stationary work on low-volume (less than 500 vehicles per day), low-speed (under 45 mph) roadways when motor vehicle traffic does not include longer and wider heavy commercial vehicles.

### Support:

Figure 6H-6 of the MUTCD illustrates a method for handling motor vehicle traffic where the stationary or short duration work space encroaches slightly into the traveled way.

## **8.8 WORK WITHIN THE MEDIAN**

### *Guidance:*

*If work in the median of a divided highway is within 15 feet from the edge of the traveled way for either direction of travel, or within the clear zone, temporary traffic control should be used through the use of advance warning signs and channelizing devices.*

## **8.9 WORK WITHIN THE TRAVELED WAY OF TWO-LANE HIGHWAYS**

### Support:

Detour signs are used to direct road users onto another roadway. At diversions, road users are directed onto a temporary roadway or alignment placed within or adjacent to the right-of-way. Examples of typical applications for detouring or diverting road users on two-lane highways can be found in Figures 6H-7, 6H-8, and 6H-9 of the MUTCD.

### **Standard:**

**Detours and diversions shall be reviewed and approved by the DDOT Engineer prior to implementation.**

*Guidance:*

*When a detour is long, Detour Marker (M4-8) or Detour (M4-9) signs should be installed to remind and reassure road users periodically that they are still successfully following the detour. When an entire roadway is closed, a detour should be provided and road users should be warned in advance of the closure. If local road users are allowed to use the roadway up to the closure, the "ROAD CLOSED TO THRU TRAFFIC" sign should be used. The portion of the road open to local road users should have adequate signing, marking, and delineation. Detours should be signed so that road users will be able to traverse the entire detour route and return to the original roadway.*

Option:

Flaggers may be used as shown in Typical Application for Lane Closures on a Minor Street (Figure9-6).

**8.9.1 WORK WITHIN THE TRAVELED WAY OF URBAN STREETS****Support:**

In urban temporary traffic control zones, decisions are needed on how to control motor vehicle traffic, such as how many lanes are required, whether any turns should be prohibited at intersections, and how to maintain access to business, industrial, and residential areas. Pedestrian traffic needs separate attention. A separate section devoted to pedestrian and worker safety contains information regarding controlling pedestrian movements near work zones.

**Standard:**

**If the temporary traffic control zone affects the movement of pedestrians, adequate pedestrian access and walkways shall be provided. If the temporary traffic control zone affects the movement of bicyclists, adequate access to the roadway, bicycle paths, or shared-use paths shall be provided (see Part 9 of the MUTCD for additional guidance).**

*Guidance:*

*If a designated bicycle route is closed because of the work being done, a signed alternate route should be provided. Bicyclists should not be directed onto the path used by pedestrians.*

**Support:**

Utility work takes place both within and outside the roadway to construct and maintain services such as power, gas, light, water, or telecommunications. Operations often involve intersections, since that is where many of the network junctions occur. The work force is usually small, only a few vehicles are involved, and the number and types of

temporary traffic control devices placed in the temporary traffic control zone is usually minimal.

**Standard:**

**All temporary traffic control devices shall be retroreflective or illuminated if utility work is performed during nighttime hours.**

*Guidance:*

*As discussed under short-duration projects, however, the reduced number of devices in utility work zones should be offset by the use of high-visibility devices, such as rotating lights or strobe lights on work vehicles.*

**8.9.2 WORK WITHIN THE TRAVELED WAY OF MULTILANE, NON-ACCESS CONTROLLED HIGHWAYS**

Support:

Work on multilane (two or more lanes in one direction) highways is divided into right-lane closures, left-lane closures, interior-lane closures, multiple-lane closures, and closures on five-lane roadways.

**Standard:**

**When a lane is closed on a multilane road, a transition area containing a merging taper and an arrow panel display shall be used.**

*Guidance:*

*When justified by an engineering study, temporary traffic barriers should be used to prevent incursions of errant vehicles into hazardous areas or work space.*

**Standard:**

**When temporary traffic barriers are placed immediately adjacent to the traveled way, they shall be equipped with appropriate channelizing devices, delineation, and/or other temporary traffic control devices. For lane closures, the merging taper shall use channelizing devices and the temporary traffic barrier shall be placed beyond the transition area.**

Support:

It must be recognized that although temporary traffic barriers are shown in several of the typical applications in this manual, they are not considered to be temporary traffic control devices in themselves.

Figure 6H-34 of the MUTCD illustrates a lane closure in which temporary traffic barriers are used.

There are four primary functions of temporary traffic barriers:

1. To keep motor vehicle traffic from entering work areas, such as excavations or material storage sites
2. To separate workers, bicyclists, and pedestrians from motor vehicle traffic
3. To separate opposing directions of motor vehicle traffic
4. To separate motor vehicle traffic, bicyclists, and pedestrians from the work area such as false work for bridges and other exposed objects

Option:

When the right lane is closed, temporary traffic control similar to that shown in Figure 6H-34 of the MUTCD may be used for undivided or divided 4-lane roads.

*Guidance:*

*If morning and evening peak hourly motor vehicle traffic volumes in the two directions are uneven and the greater volume is on the side where the work is being done in the right lane, consideration should be given to closing the inside lane for opposing motor vehicle traffic and making the lane available to the side with heavier motor vehicle traffic. If the larger motor vehicle traffic volume changes to the opposite direction at a different time of the day, the temporary traffic control should be changed to allow two lanes for opposing motor vehicle traffic by moving the devices from the opposing lane back to the centerline. When it is necessary to create a temporary centerline that is not consistent with the pavement markings, channelizing devices should be used and closely spaced.*

**Support:**

Peak Hours in the District of Columbia are defined as the hours of 6:30 a.m. to 9:30 a.m. and 3:30 p.m. to 6:30 p.m., Monday through Friday, except holidays. “Off-peak hours” occur during those hours and days not identified as “peak hours.”

Option:

When closing a left lane on a multilane undivided road, as motor vehicle traffic flow permits, the two interior lanes may be closed to provide motorists and workers additional lateral clearance and to provide access to the work space.

**Standard:**

**When only the left lane is closed on undivided roads, channelizing devices shall be placed along the centerline as well as along the adjacent lane.**

*Guidance:*

*When an interior lane is closed, an adjacent lane should also be considered for closure (when available and practical) to provide additional space for vehicles and materials and to facilitate the movement of equipment within the work space. When multiple lanes in one direction are closed, a capacity analysis should be made to determine the number of lanes needed to accommodate motor vehicle traffic needs. Motor vehicle traffic should be moved over one lane at a time. As shown in Figure 6H-37 of the MUTCD, the tapers should be separated by a distance of  $2L$ , with  $L$  being determined by the formulas in Table 4-2.*

**Standard:**

**When a directional roadway is closed, inapplicable “WRONG WAY” signs and markings and other existing traffic control devices at intersections within the temporary two-lane, two-way operations section shall be covered, removed, or obliterated.**

Option:

When half the road is closed on an undivided highway, both directions of motor vehicle traffic may be accommodated as shown in Figure 6H-32 of the MUTCD. When both interior lanes are closed, temporary traffic controls may be used as indicated in Figure 6H-37 of the MUTCD for both directions of travel. When a roadway must be closed on a divided highway, a median crossover may be used.

## Support:

Temporary traffic control for lane closures on 5-lane roads is similar to other multilane undivided roads. Figure 6H-32 of the MUTCD can be adapted for use on 5-lane roads.

**8.9.3 WORK WITHIN THE TRAVELED WAY AT INTERSECTIONS**

## Support:

The typical traffic control applications for intersections are classified according to the location of the work space with respect to the intersection area (as defined by the extension of the curb or edge lines). The three classifications are near side, far side, and in-the-intersection. Work spaces often extend into more than one portion of the intersection. For example, work in one quadrant often creates a near-side work space on one street and a far-side work space on the cross street. In such instances, an appropriate temporary traffic control plan is obtained by combining features shown in two or more of

the intersections and pedestrian typical applications. Temporary traffic control zones in the vicinity of intersections might block movements and interfere with normal road user flows. Such conflicts frequently occur at more complex signalized intersections having such features as traffic signal heads over particular lanes, lanes allocated to specific movements, multiple signal phases, and signal detectors for actuated control.

*Guidance:*

*The effect of the work upon signal operation should be considered, such as signal phasing for ensuring adequate capacity, maintaining or adjusting signal detectors, and ensuring the appropriate visibility of signal heads.*

**Standard:**

**When work will occur near signalized intersections where operational and capacity problems are anticipated, DDOT shall be contacted.**

*Guidance:*

*When work will occur near non-signalized intersections where operational and capacity problems are anticipated, the highway agency having jurisdiction should be contacted.*

*For work at an intersection, advance warning signs, devices, and markings should be used on all cross streets, as appropriate. The typical traffic control figures depict urban intersections on arterial streets. Where the posted speed limit, the off-peak 85<sup>th</sup>-percentile speed prior to the work starting, or the anticipated speed exceeds 40 mph, additional warning signs should be used in the advance warning area.*

**Support:**

Near-side work spaces, as depicted in Figure 6H-21 of the MUTCD, are simply handled as a midblock lane closure. A problem that might occur with near-side lane closure is a reduction in capacity, which during certain hours of operation could result in congestion and backups.

Option:

When near-side work spaces are used, an exclusive turn lane may be used for through motor vehicle traffic. Where space is restricted in advance of near-side work spaces, as with short block spacing, two warning signs may be used in the advance warning area, and a third action-type warning or regulatory sign (such as “KEEP LEFT”) may be placed within the transition area.

Support:

Far-side work spaces, as depicted in Figures 9-9 and 9-10 of the Typical Applications, involve additional treatment because road users typically enter the activity area by straight-through and left- or right-turning movements.

*Guidance:*

*When a lane through an intersection must be closed on the far side, it should also be closed on the near-side approach to preclude merging movements within the intersection.*

Option:

If, however, there are a significant number of vehicles turning from a near-side lane that is closed on the far side, the near-side lane may be converted to an exclusive turn lane.

Support:

Figures 9-11 through 9-14 of the Typical Applications provide guidance on applicable procedures for work performed within the intersection.

Option:

If the work is within the intersection, any of the following strategies may be used:

- A. A small work space so that road users can move around it, as shown in Figure 9-11
- B. Flaggers to assign the right-of-way to each leg entering the intersection
- C. Work in stages so the work space is kept small
- D. Road closures or upstream diversions to reduce road user volumes

*Guidance:*

*Depending on road user conditions, flaggers and/or a uniformed law enforcement officer(s) should be used to control road users.*

#### **8.9.4 WORK WITHIN THE TRAVELED WAY OF EXPRESSWAYS AND FREEWAYS**

Support:

Problems of temporary traffic control might occur under the special conditions encountered where motor vehicle traffic must be moved through or around temporary traffic control zones on high-speed, high-volume roadways. Although the general principles outlined in the previous Sections of this Manual are applicable to all types of highways, high-speed, access-controlled highways need special attention in order to

safely and efficiently accommodate motor vehicle traffic while also protecting work forces. The road user volumes, road vehicle mix (buses, trucks, and cars), and speed of vehicles on these facilities require that careful temporary traffic control procedures be implemented, for example, to induce critical merging maneuvers well in advance of work spaces and in a manner that creates minimum turbulence and delay in the motor vehicle traffic stream. These situations often require more conspicuous devices than specified for normal rural highway or urban street use. However, the same important basic considerations of uniformity and standardization of general principles apply for all roadways.

Work under high-speed, high-volume motor vehicle traffic on a controlled access highway is complicated by the roadway design and operational features. The presence of a median that establishes separate roadways for directional motor vehicle traffic flow might prohibit the closing of one of the roadways or the diverting of motor vehicle traffic to the other roadway. Lack of access to and from adjacent roadways prohibits rerouting of motor vehicle traffic away from the work space in many cases. Other conditions exist where work must be limited to night hours, thereby necessitating increased use of warning lights, illumination of work spaces, and advance warning systems.

Temporary traffic control for a typical lane closure on a divided highway is shown in Figure 6H-33 of the MUTCD. Temporary traffic controls for short duration and mobile operations on freeways are shown in Figure 6H-35. A typical application for shifting motor vehicle traffic lanes around a work space is shown in Figure 6H-36 of the MUTCD. Temporary traffic controls for multiple and interior lane closures on a freeway are shown in Figure 6H-38 of the MUTCD.

*Guidance:*

*The method for closing an interior lane when the open lanes have the capacity to carry motor vehicle traffic should be as shown in Figure 6H-38 of the MUTCD.*

### **8.10 TWO-LANE, TWO-WAY TRAFFIC ON ONE ROADWAY OF A NORMALLY DIVIDED HIGHWAY**

**Support:**

Two-lane, two-way operation on one roadway of a normally divided highway is a typical procedure that requires special consideration in the planning, design, and work phases, because unique operational problems (for example, increasing the risk of head-on crashes) can arise with the two-lane, two-way operation.

**Standard:**

**When two-lane, two-way traffic control must be maintained on one roadway of a normally divided highway, opposing motor vehicle traffic shall be separated with either temporary traffic barriers (concrete safety-shape or approved alternate) or**



**with channelizing devices throughout the length of the two-way operation. The use of markings and complementary signing, by themselves, shall not be used.**

Support:

Figure 6H-39 of the MUTCD shows the procedure for two-lane, two-way operation. Treatments for entrance and exit ramps within the two-way roadway segment of this type of work are shown in Figures 6H-40 and 6H-41 of the MUTCD. Modifications to any of these layouts must first be reviewed and approved by the DDOT Engineer prior to their usage.

## **8.11 CROSSOVERS**

*Guidance:*

*The following are considered good guiding principles for the design of crossovers:*

- A. Tapers for lane drops should be separated from the crossovers.*
- B. Crossovers should be designed for speeds no lower than 10 mph below the posted speed, the off-peak 85th-percentile speed prior to the work starting, or the anticipated operating speed of the roadway, unless unusual site conditions require that a lower design speed be used.*
- C. A good array of channelizing devices, delineators, glare screens along the crossover, and full-length, properly placed pavement markings should be used to provide motorists with a clearly defined travel path.*
- D. The design of the crossover should accommodate all motor vehicle traffic, including trucks and buses.*

Support:

Temporary traffic barriers and the excessive use of temporary traffic control devices cannot compensate for poor geometric and roadway cross-section design of crossovers.

## **8.12 INTERCHANGES**

*Guidance:*

*Access to interchange ramps on limited-access highways should be maintained even if the work space is in the lane adjacent to the ramps. Access to exit ramps should be clearly marked and delineated with channelizing devices. For long-term projects, conflicting pavement markings should be removed and new ones placed. Early coordination with officials having jurisdiction over the affected cross streets and providing emergency services should occur before ramp closings.*

Option:

If access is not possible, ramps may be closed by using signs and Type III barricades. As the work space changes, the access area may be changed, as shown in Figure 6H-42 of the MUTCD. A temporary traffic control zone in the exit ramp may be handled as shown in Figure 6H-43. When a work space interferes with an entrance ramp, a lane may need to be closed on the freeway. A temporary traffic control zone in the entrance ramp may require shifting ramp motor vehicle traffic. Temporary traffic control for both operations is shown in Figure 6H-44 of the MUTCD.

**8.13 MOVABLE BARRIERS**

Support:

Figure 6H-45 of the MUTCD shows a temporary reversible lane using movable barriers.

**Standard:**

**Modifications to Figure 6H-45 of the MUTCD shall be reviewed and approved by the DDOT Engineer prior to its use.**

Option:

If the work activity in Figure 6H-45 of the MUTCD permits, a movable barrier may be used and relocated to the shoulder during non-work periods or peak-period motor vehicle traffic conditions.

**8.14 WORK IN THE VICINITY OF HIGHWAY-RAIL GRADE CROSSINGS**

**Standard:**

**When highway-rail grade crossings exist either within, or in the vicinity of, a temporary traffic control zone, lane restrictions, flagging, or other operations shall not create conditions where vehicles can be stopped on the railroad tracks with no means of escape. If the queuing of vehicles across the tracks cannot be avoided, a law enforcement officer or certified flagger shall be provided at the crossing to prevent vehicles from stopping on the tracks, even if automatic warning devices are in place.**

Support:

Figure 6H-46 of the MUTCD shows work in the vicinity of a highway-rail grade crossing.

*Guidance:*

*Early coordination with the railroad company should occur before work starts.*

**8.15 CONTROL OF TRAFFIC THROUGH INCIDENT AREAS****Support:**

An incident is an emergency road user occurrence, a natural disaster, or a special event. The primary functions of temporary traffic control at an incident area are to move road users safely and expeditiously through or around the incident and to reduce the likelihood of secondary crashes. Examples include a stalled vehicle blocking a lane, a road user crash blocking the traveled way, a chemical spill along a highway, floods and severe storm damage, a planned visit by a dignitary, or a major sporting event.

**Guidance:**

*In order to reduce response time for incident management, highway agencies and municipalities should preplan for occurrences of incidents along the major and heavily traveled highway and street system. Special events should be planned for and coordinated in advance.*

**Support:**

While some incidents might be anticipated and planned for, emergencies and disasters might pose more severe and unpredictable problems. The ability to install proper temporary traffic control might greatly reduce the effects of an emergency. An essential part of fire, rescue, spill clean-up, and enforcement activities is the proper control of road users through the incident area. These operations need corroborating legislative authority for the implementation and enforcement of appropriate road user regulations, parking controls, and speed zoning. It is desirable for these statutes to provide sufficient flexibility in the authority for and implementation of temporary traffic control to respond to the needs of changing conditions found in incident areas.

**Option:**

For unexpected incidents, particularly those of an emergency nature, temporary traffic control devices on hand may be used for the initial response as long as they do not themselves create unnecessary additional hazards.

**Standard:**

**If the incident is anticipated to last more than three days, applicable procedures and devices set forth in this manual shall be used.**

**Support:**

A short-term road closure can be caused by an incident such as a road user crash that blocks the traveled way. Road users are usually detoured around the incident and back to the original roadway. A combination of traffic engineering and enforcement preparations is needed to determine the detour route and install the necessary devices. Large trucks are

a significant concern in such a detour. During incidents, large trucks might need to follow a route separate from that of automobiles because of bridge, weight, clearance, or geometric restrictions. Also, vehicles carrying hazardous cargo might need to follow a different route from other vehicles.

Some incidents such as hazardous spills might require closure of an entire highway. Through road users must have adequate guidance around the incident. Maintaining good public relations is desirable. The cooperation of the news media in publicizing the existence of and reasons for incident areas and their temporary traffic control can be of great assistance in keeping road users and the general public well informed.

*Guidance:*

*The channelizing devices discussed in the previous section should be used whenever possible. When flares are used to initiate temporary traffic control at incidents or for short-term temporary traffic control, they should be replaced by more permanent devices as soon as practical. Both the flare and its supporting device should be removed from the roadway.*

## **8.16 WORK DURING INCLEMENT WEATHER**

**Support:**

Inclement weather (rain, snow, fog, etc.) creates the following conditions for road users: lack of visibility to the road and temporary traffic control devices; greater distance required to slow and stop a motor vehicle; an increase in the difficulty of controlling a motor vehicle; and an increase in distraction and anxiety for road users while traveling on the roadway.

*Guidance:*

*Therefore, planned work activities should be avoided, if possible, during inclement weather conditions.*

Option:

Emergency operations, however, may be performed where inaction would be worse than allowing the condition to remain unattended.



## SECTION 9 - TYPICAL APPLICATIONS

Support:











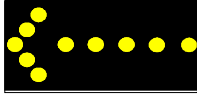

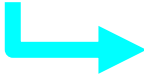
The diagrams on the following pages represent examples of the application of principles and procedures for safe and efficient traffic control in temporary traffic control zones and are not intended to be standards. It is not possible to include illustrations to cover every situation which will require work area protection. These typical layouts are not intended as a substitute for engineering judgment and should be altered to fit the conditions of a particular site. Contractor plans or other agency documents may also have applicable layouts to be followed.

The diagrams are not to scale, and the number of channelizing devices shown may not be the number needed at the work site. The tables on the typical applications are to be used to determine taper and buffer lengths, using Section 7 for guidance on the spacing and number of devices.

Notes and tables found throughout Section 9 provide information for the development of temporary traffic control zones. Read all notes before using these diagrams.

In general, the procedures illustrated represent minimum solutions for the situations depicted. For further information, refer to Part 6 of the MUTCD. It contains the standards for work zone traffic control, including sign type numbers and dimensions of signs.

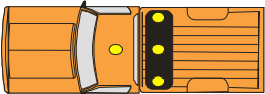

	Arrow panel
	Arrow panel support or trailer (shown facing down)
	Channelizing Device
	Direction of temporary traffic detour
	Direction of traffic
	Flagger
	High level warning device (Flag Tree)
	Illuminated Flashing Amber (caution Mode) Type B or C
	Sign (shown facing left)
	Truck mounted attenuator
	Traffic Signal
	Type III barricade
	Work Zone
	Work Vehicle with Flashing Light

**Table 9-1. Symbols on Typical Application Diagrams**



**Notes for Figure 9-1**

A Road Work Ahead sign should be placed on the left side of the roadway for a divided or one-way street only if the left shoulder is affected.

The Worker Symbol (W21-1) signs may be used instead of Road Work Ahead signs.

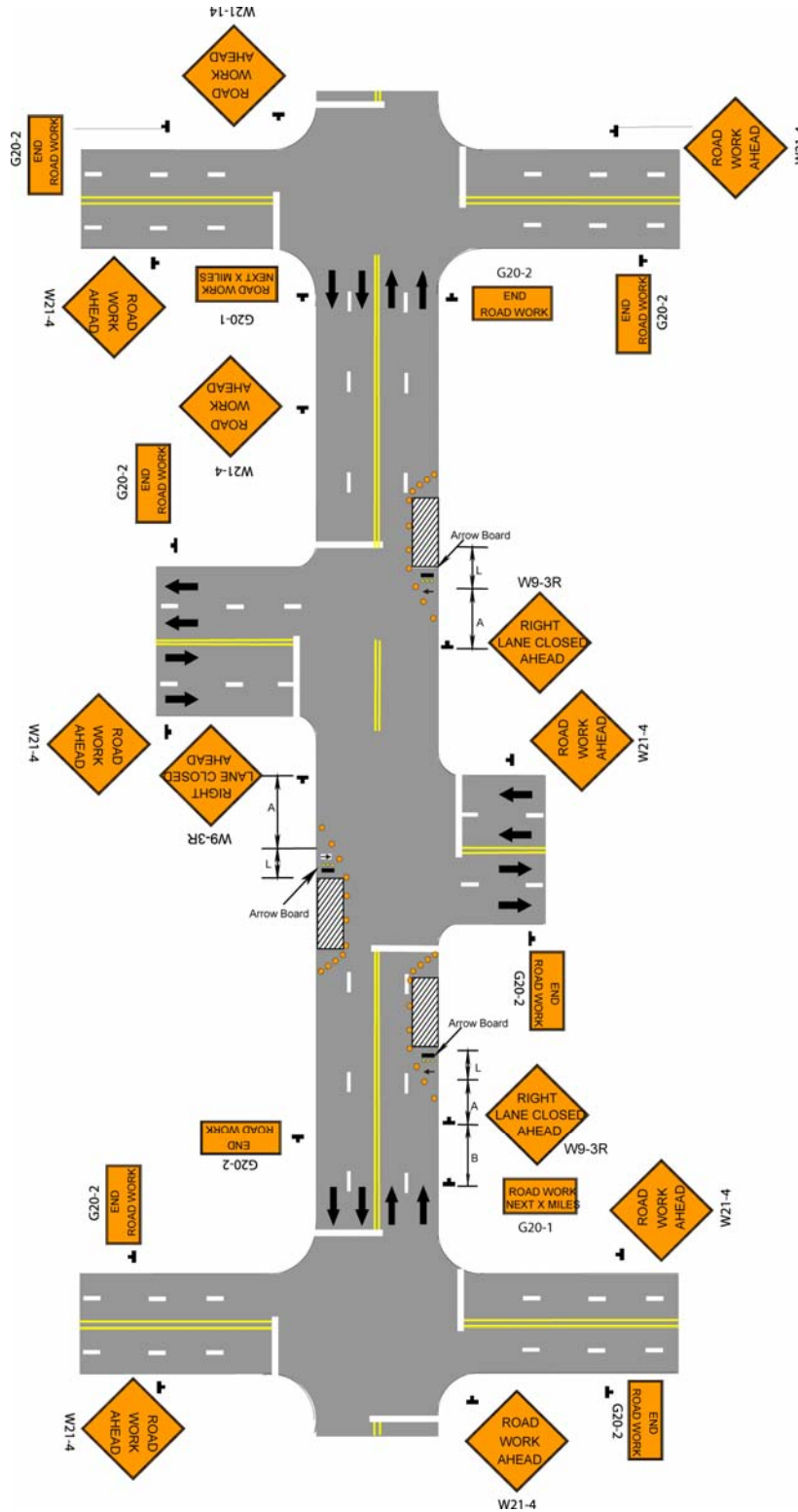

Figure 9-1. Typical Application: Closures on Curb Lanes

**Notes for Figure 9-2**

In those situations where multiple work locations within a limited distance make it practical to place stationary signs, the distance between the advance warning sign and the work should not exceed one block in urban low-speed areas or one mile on high-speed roads.

Each vehicle involved in the mobile operation shall have at least one rotating amber light or high intensity amber strobe light.

“Utility Work Ahead” may be used in low-speed urban areas or “Shoulder Work Ahead” may be used along highways with shoulders.

72-hour advanced parking restrictions are required for mobile operations, except in the event of an emergency.

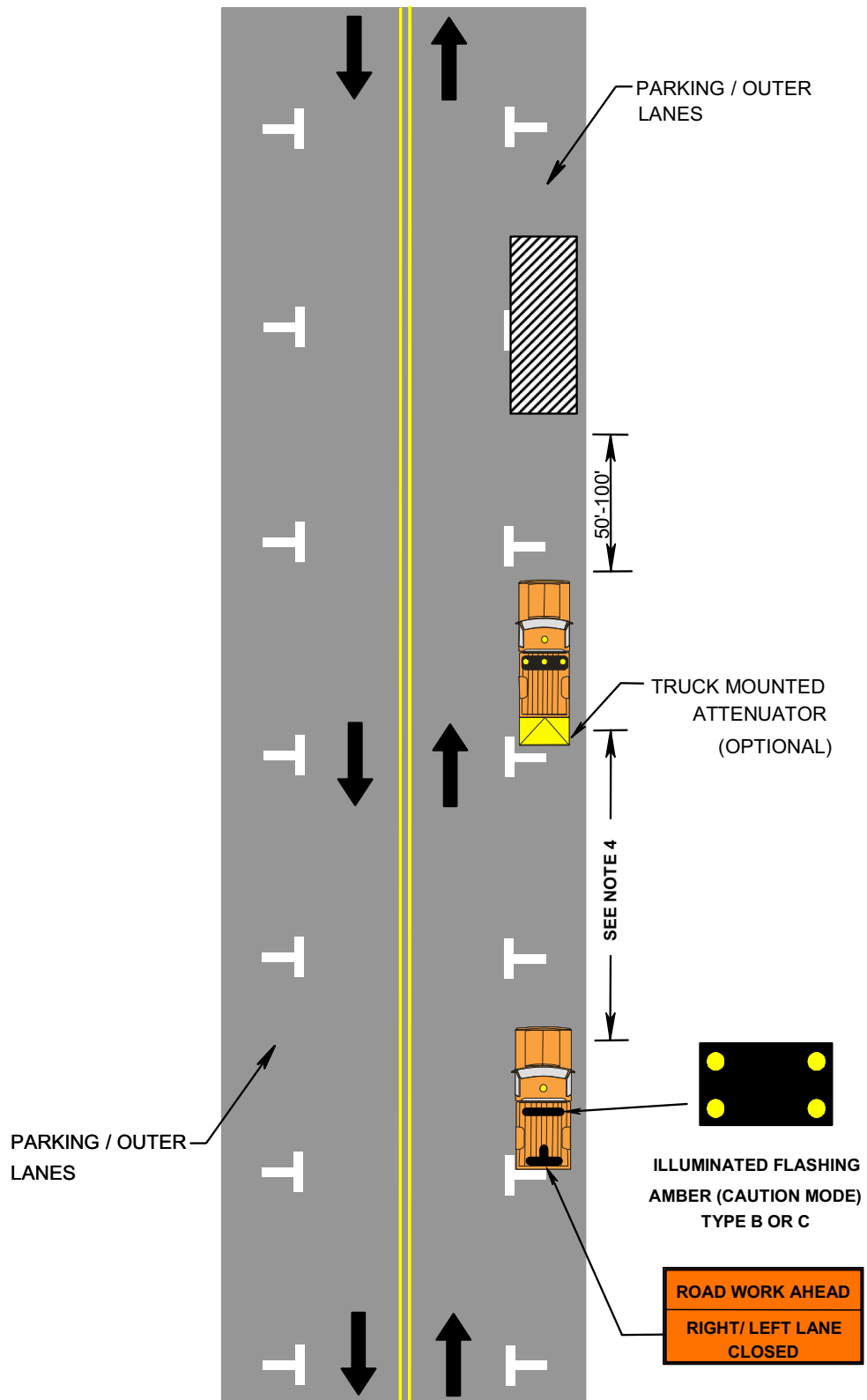

Figure 9-2. Typical Application: Mobile or Short Duration

**Notes for Figure 9-3**

Vehicle-mounted signs shall be mounted with the bottom of the sign at a minimum height of 48 inches above the pavement. Sign legends shall be covered or turned from view when work is not in progress.

Shadow and work vehicles shall display rotating lights or strobe lights.

Provision of a Truck Mounted Attenuator (TMA) on the leading vehicles is dependent on the following distance between the two vehicles. If following distance is greater than values below, a TMA is required.

**Maximum Following Distance**

<b>Posted Speed Limit ( mph)</b>	<b>Following Distance (ft)</b>
25	250
30	300
35	300
40	400
45	450
50	500
55	550

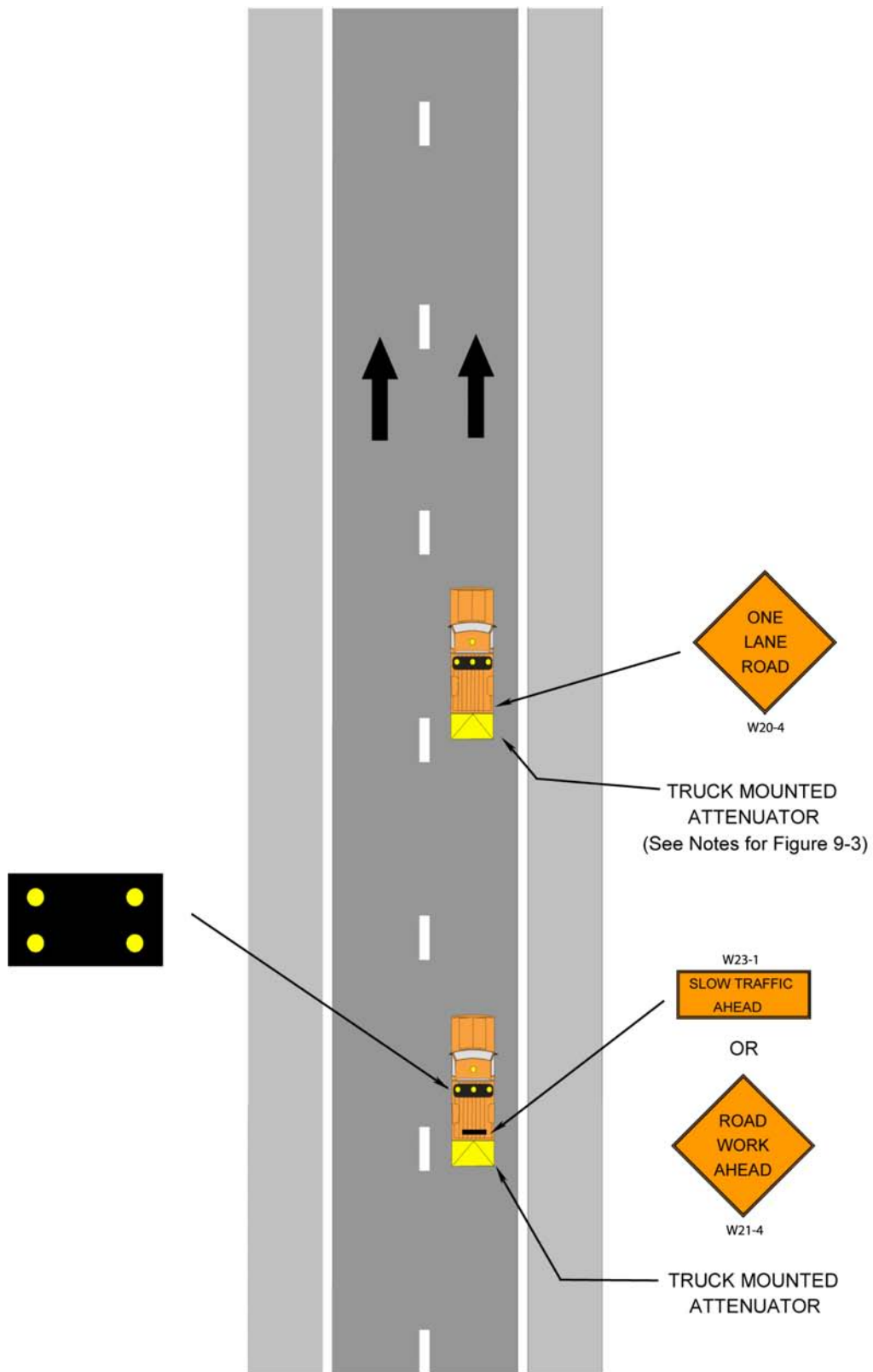

Figure 9-3. Typical Application: Mobile Operations on a High-Speed Road

### Notes for Figure 9-4

In those situations where multiple work locations within a limited distance make it practical to place stationary signs, the distance between the advance warning sign and the work should not exceed one block in urban low-speed areas or one mile on high-speed roads.

This application is shown where encroachment occurs in the parking lane or curb lane. In cases where there are shoulders, the “Right Lane Closed Ahead” sign will be replaced with a “Shoulder Work” sign (i.e. on divided high-speed highways). Spacing will vary depending on road classification type and speed. Refer to Part 6 of the MUTCD.

Each vehicle involved in the mobile operation shall have at least one rotating amber light or high intensity amber strobe light.

Any situation or location that requires more than three days of lane closures or impacts requires installation of temporary pavement markings.

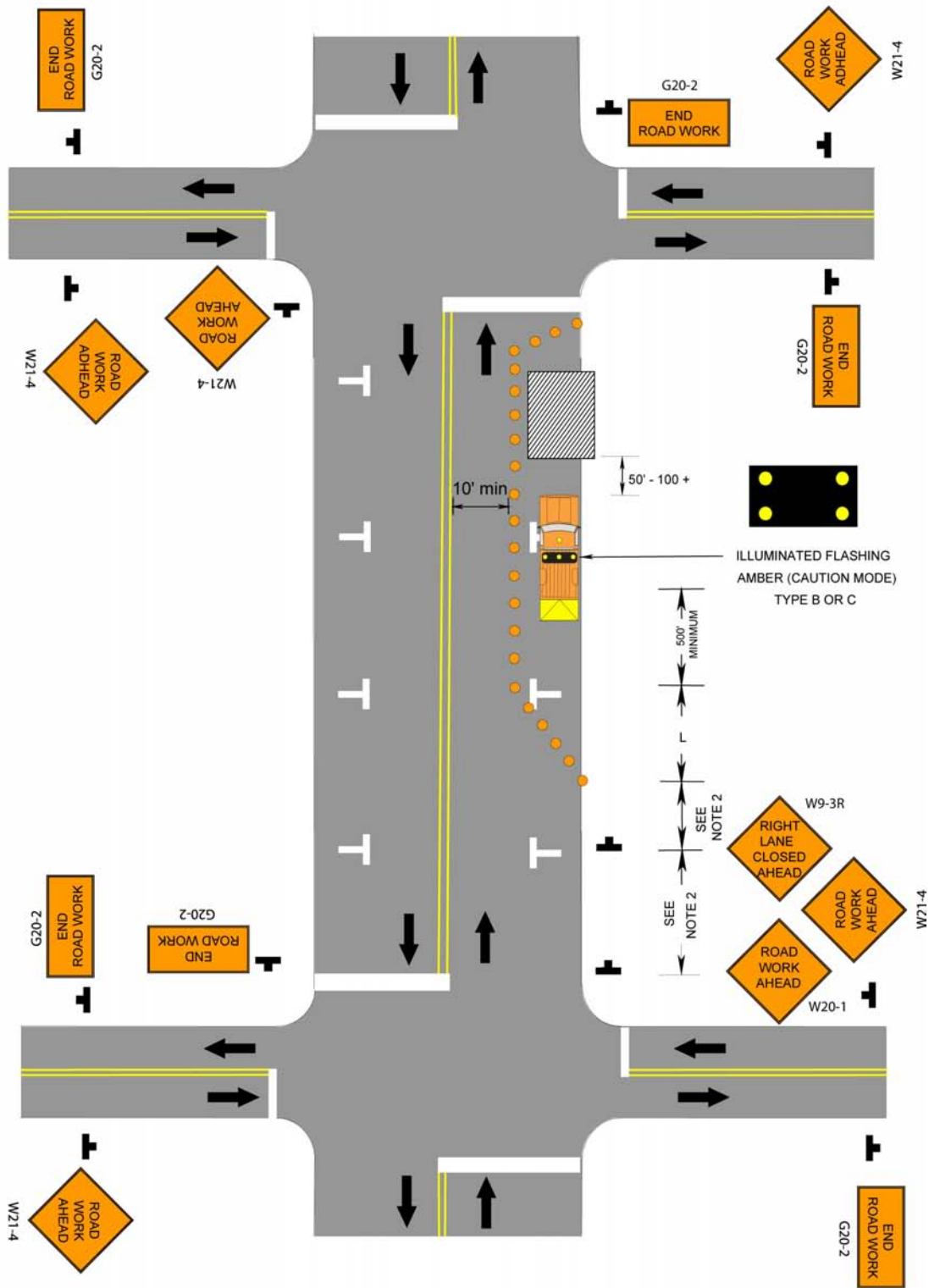

Figure 9-4. Typical Application: Moderate Duration or Stationary Operation  
Notes for Figure 9-5



Where buses are permitted, the lanes on either side of the center work space should have a minimum width of 11 feet as measured from the near edge of the channelizing devices to the edge of pavement or the outside edge of paved shoulder.

Flashing warning lights and/or flags may be used to call attention to the advanced warning signs.

If the closure continues overnight, warning lights may be used on the channelizing devices.

A lane width of 10 feet may be used for short-term stationary work on low-volume, low-speed roadways when motor vehicle traffic does not include longer and wider heavy commercial vehicles and where buses are restricted.

A work vehicle displaying rotating lights or strobe lights may be used instead of the channelizing devices forming the tapers or the high-level warning devices.

Although vehicle hazard warning signals can be used to supplement the rotating light or strobe lights, they shall not be used instead of rotating lights or strobe lights.

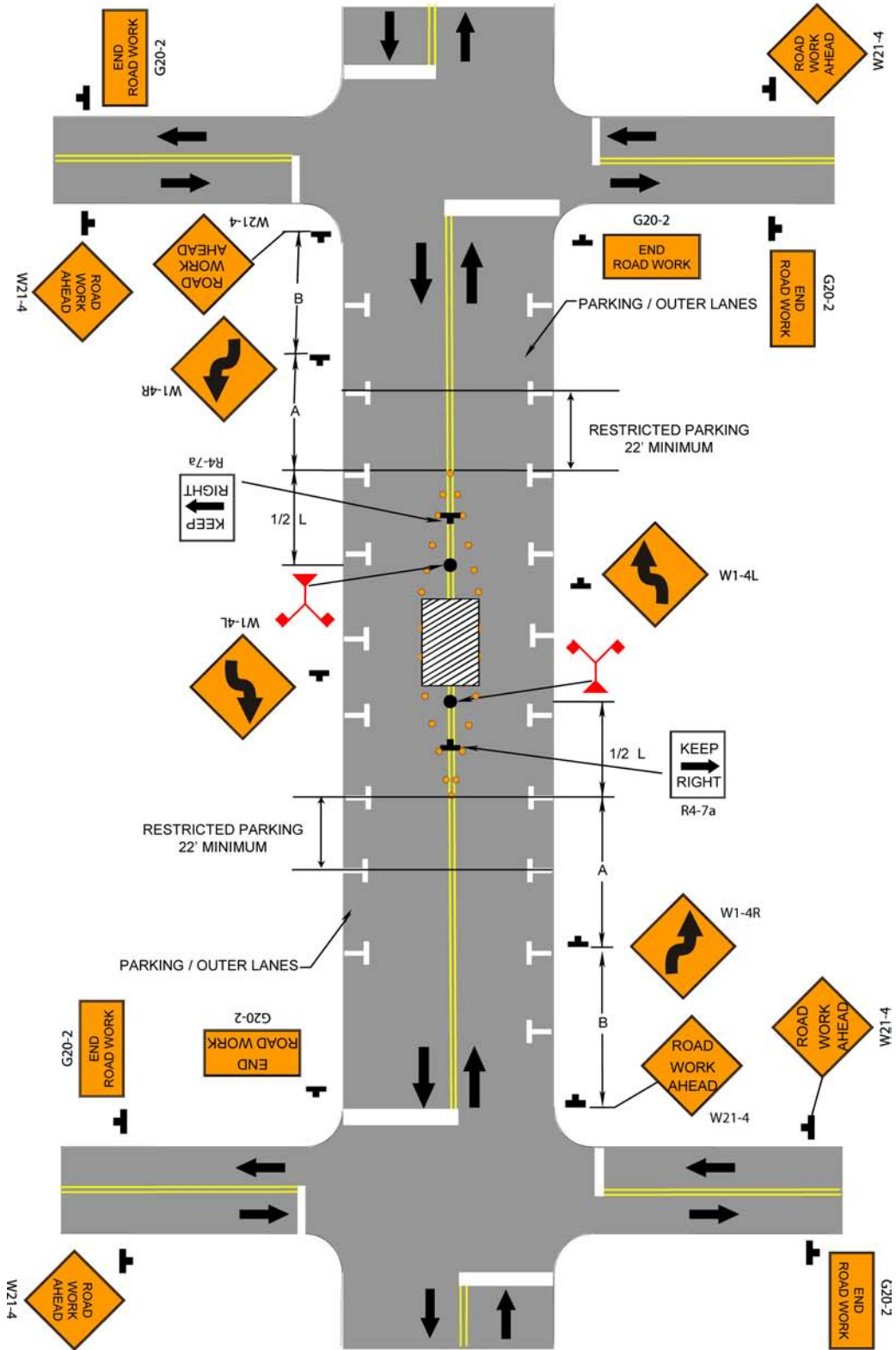

Figure 9-5. Typical Application: Closure in the Center of a Local or Low-Volume Road

**Notes for Figure 9-6**

This temporary traffic control shall be used only for low-volume, low-speed facilities.

When motor vehicle traffic cannot effectively self-regulate, one or two flaggers shall be used.



**Notes for Figure 9-7**

This layout is appropriate for city streets and local roadways. See Figure 6H-8 or 6H-9 of Part 6 of the MUTCD for closing and detouring a numbered highway.

When used, the Street Name sign shall be placed above the Detour sign.

The STREET CLOSED legend may be used in place of ROAD CLOSED.

When a side road intersects the roadway within the work zone, place Type III barricades and ROAD CLOSED signs at the intersection, and provide advance signing of the closure on the side road approaches.

DETOUR signs may be located on the far side of the intersections, provided the intersection width does not create a sight distance issue.



**Notes for Figure 9-8**

This layout is appropriate for city streets and local roadways. See Figure 6H-8 or 6H-9 of Part 6 of the MUTCD, for closing and detouring a numbered highway.

When used, the Street Name sign shall be placed above the Detour sign.

The STREET CLOSED legend may be used in place of ROAD CLOSED.

When a side road intersects the roadway within the work zone, place Type III barricades and ROAD CLOSED signs at the intersection and provide advance signing of the closure on the side road approaches.

DETOUR signs may be located on the far side of the intersections, provided the intersection width does not create a sight distance issue.

The District Fire Marshall must give approval prior to the beginning of work on this type of application.

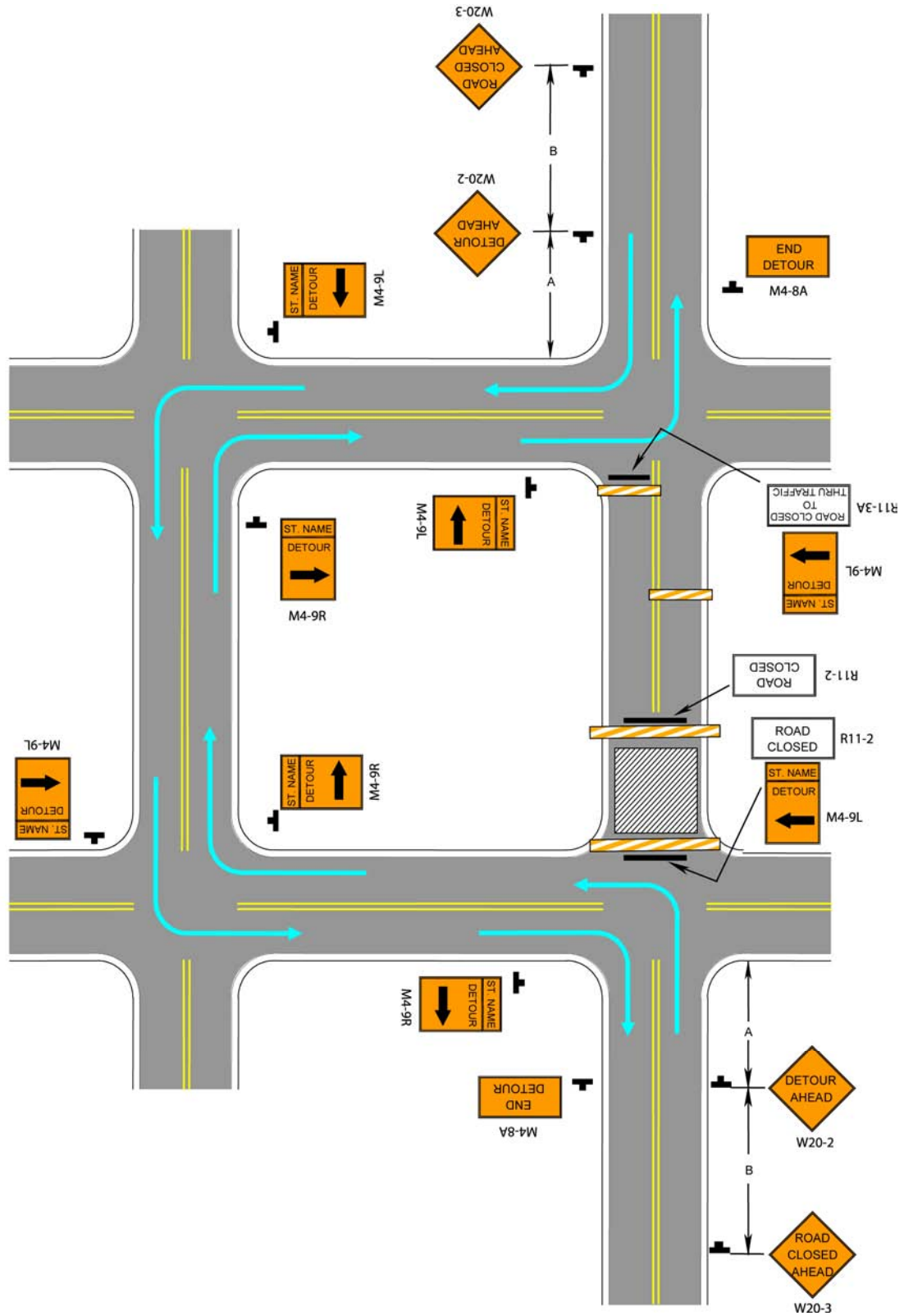

Figure 9-8. Typical Application: Road Closure and Detour for Two Travel Directions



**Notes for Figure 9-9**

The normal procedure is to close, on the near side of the intersection, any lane that is not carried through the intersection. However, when this results in the closure of a right lane having significant right-turning movements, the right lane may be restricted to right turns only. This procedure increases the through capacity by eliminating right turns from the open through lane.

If the work space extends across a crosswalk, the crosswalk should be closed using the procedures and methods shown at the end of these typical applications (see Sidewalk Closure and Bypass Sidewalk Operation).

When the turning radius is large, it may be possible to create a right-turn island using channelizing devices.

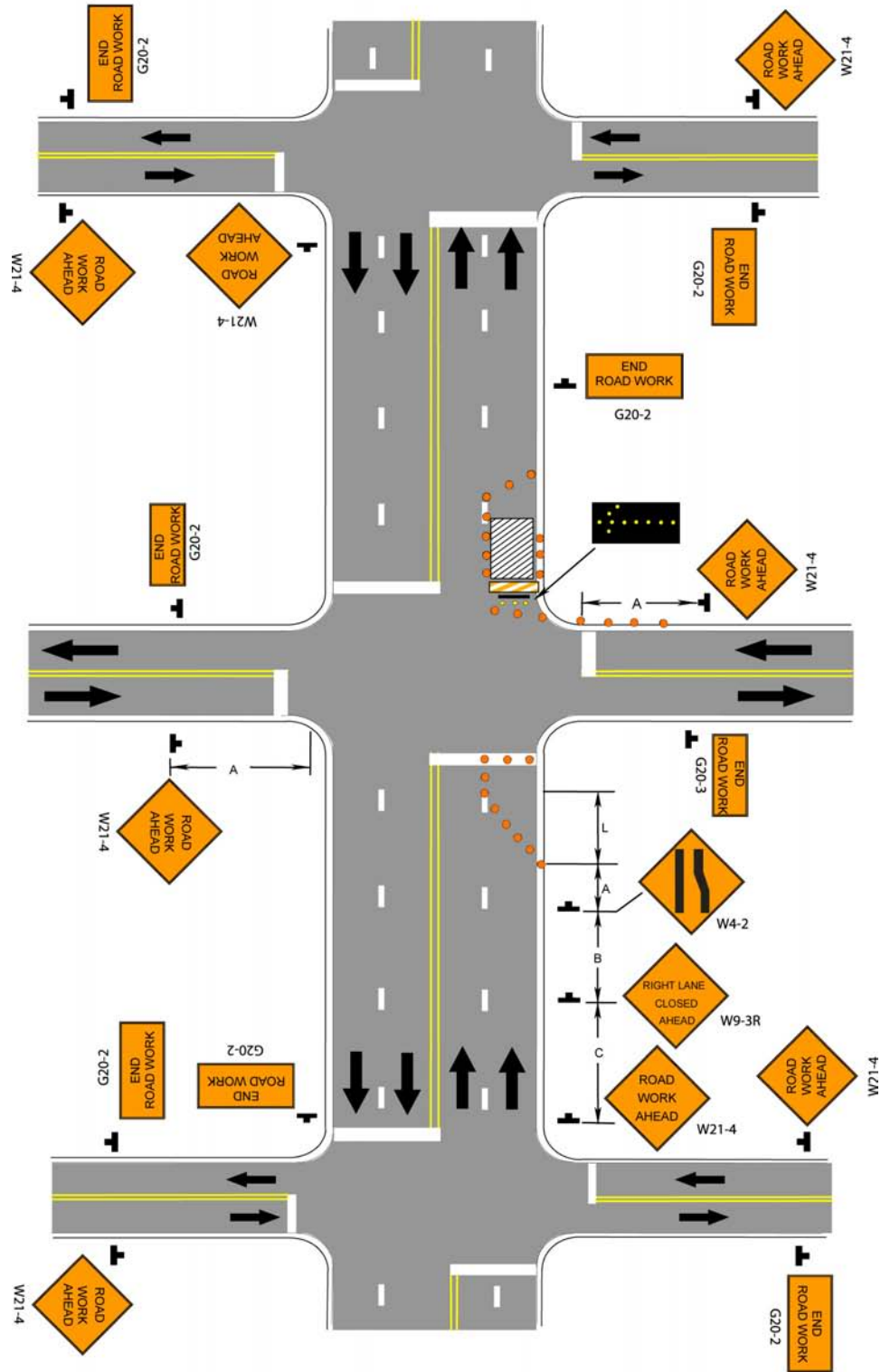

Figure 9-9. Typical Application: Right Lane Closure at Far Side of the Intersection

### **Notes for Figure 9-10**

The normal procedure is to close, on the near side of the intersection, any lane that is not carried through the intersection. However, when this results in the closure of a left lane having significant left-turning movements, the left lane may be reopened as a turn bay for left turns only, as shown. This procedure increases the through capacity by eliminating left turns from the open through lane.

If the work space extends across a crosswalk, the crosswalk should be closed using the procedures and methods shown at the end of these typical applications (see Sidewalk Closure and Bypass Sidewalk Operation).

If heavy through movements typically utilize the left lane, channelization devices should be used to close off the left lane with a taper and then the lane may be reopened, as shown in Figure 6H-23 in Part 6 of the MUTCD.

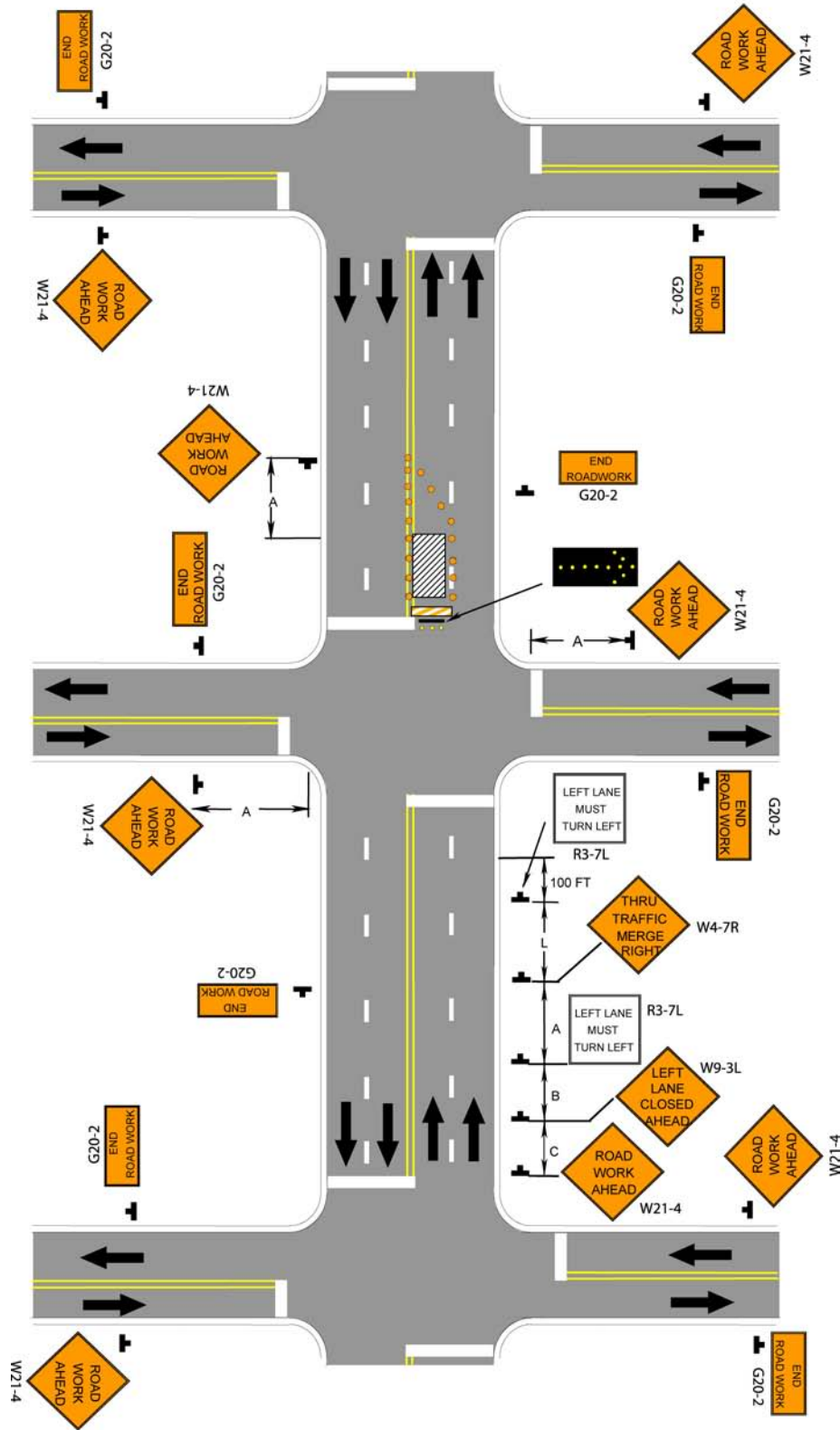

Figure 9-10. Typical Application: Left Lane Closure at Far Side of the Intersection

**Notes for Figure 9-11**

If the work space extends across a crosswalk, the crosswalk should be closed using the procedures and methods shown at the end of these typical applications (see Sidewalk Closure and Bypass Sidewalk Operation).

If the left through lane is closed on the near-side approach, the LEFT LANE MUST TURN LEFT sign should be placed in the median to discourage through vehicular traffic from entering the left-turn bay.

If the situation or location remains under construction for greater than three days, the KEEP RIGHT is replaced with an R4-7 sign.

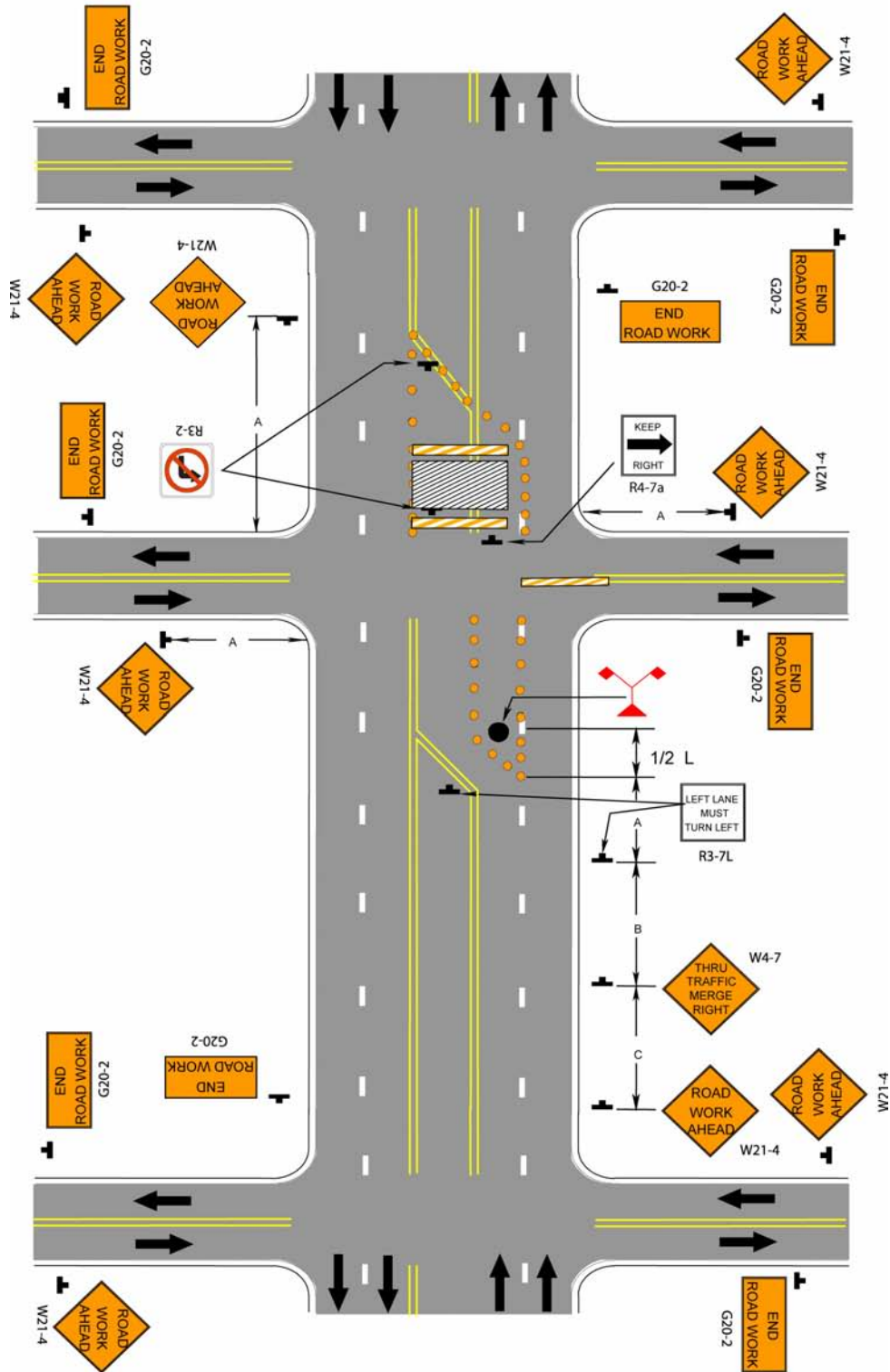

Figure 9-11. Typical Application: Multiple Closures at Intersection  
Notes for Figure 9-12

A high-level warning device may be placed in the work space if there is sufficient room.

For short-term use on low-volume, low-speed roadways, with vehicular traffic that does not include heavy commercial vehicles or buses, a minimum of 10 feet may be used.

Unless the streets are wide, it may be physically impossible to turn left, especially for large vehicles. Left turns may be prohibited as required by geometric conditions.

If the situation or location remains under construction for greater than three days, the KEEP RIGHT is replaced with an R4-7 sign.

The arrow panel should be placed as close to the beginning of the taper as possible and as space allows.

A taper length of  $\frac{1}{2} L$  is the minimum allowed IF approved by the Engineer (for roadways where bus and trucks are restricted); otherwise, use a shifting taper of L.

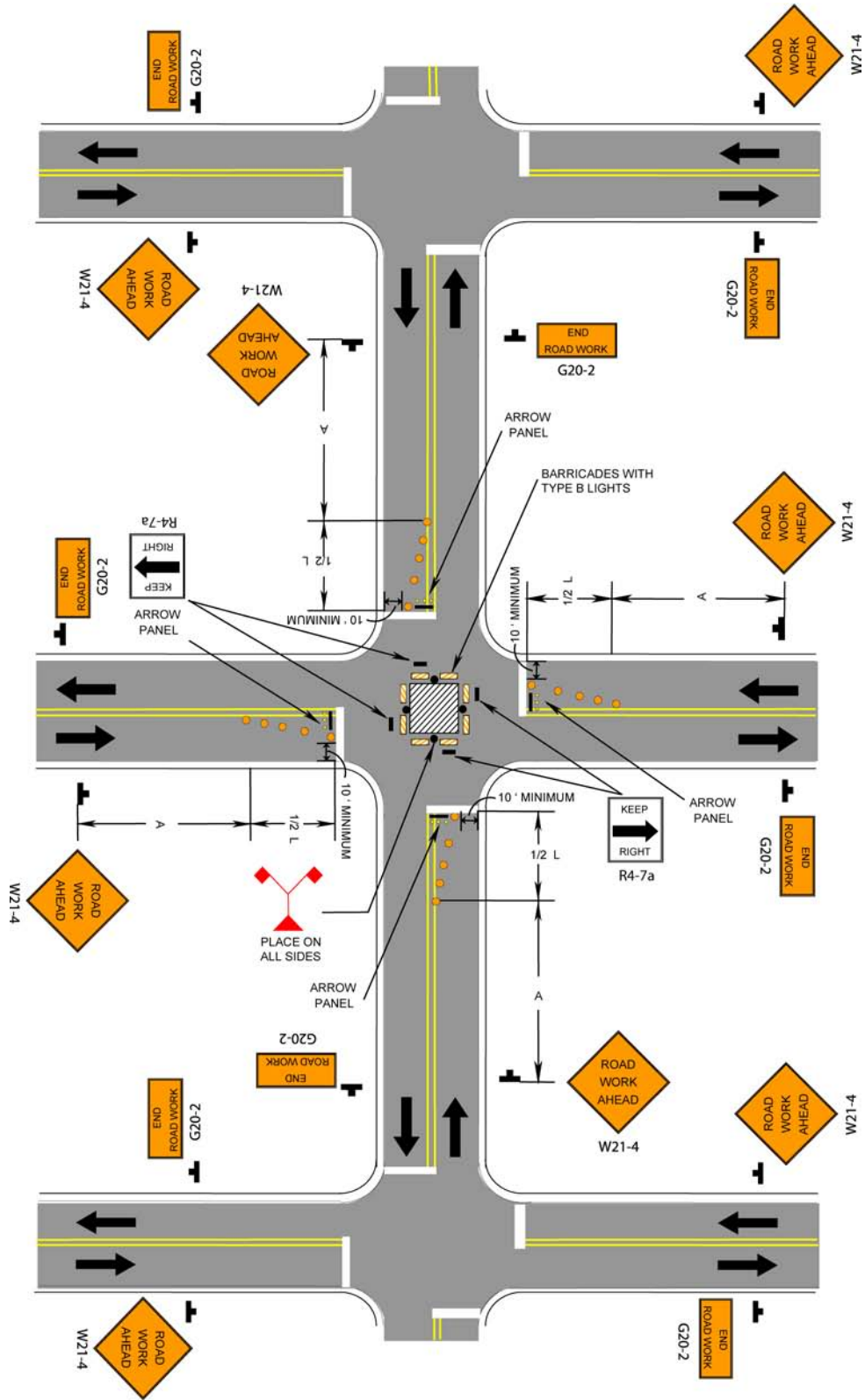

Figure 9-12. Typical Application: Closure in Center of Intersection



**Notes for Figure 9-13**

The situation depicted may be simplified by closing one or more of the intersection approaches. If this cannot be done and/or when capacity is a problem, through vehicular traffic should then be directed to other roads or streets.

Turns can be prohibited as required by vehicular traffic conditions. Unless the streets are wide, it might be physically impossible to make certain turns, especially for commercial vehicles or buses.

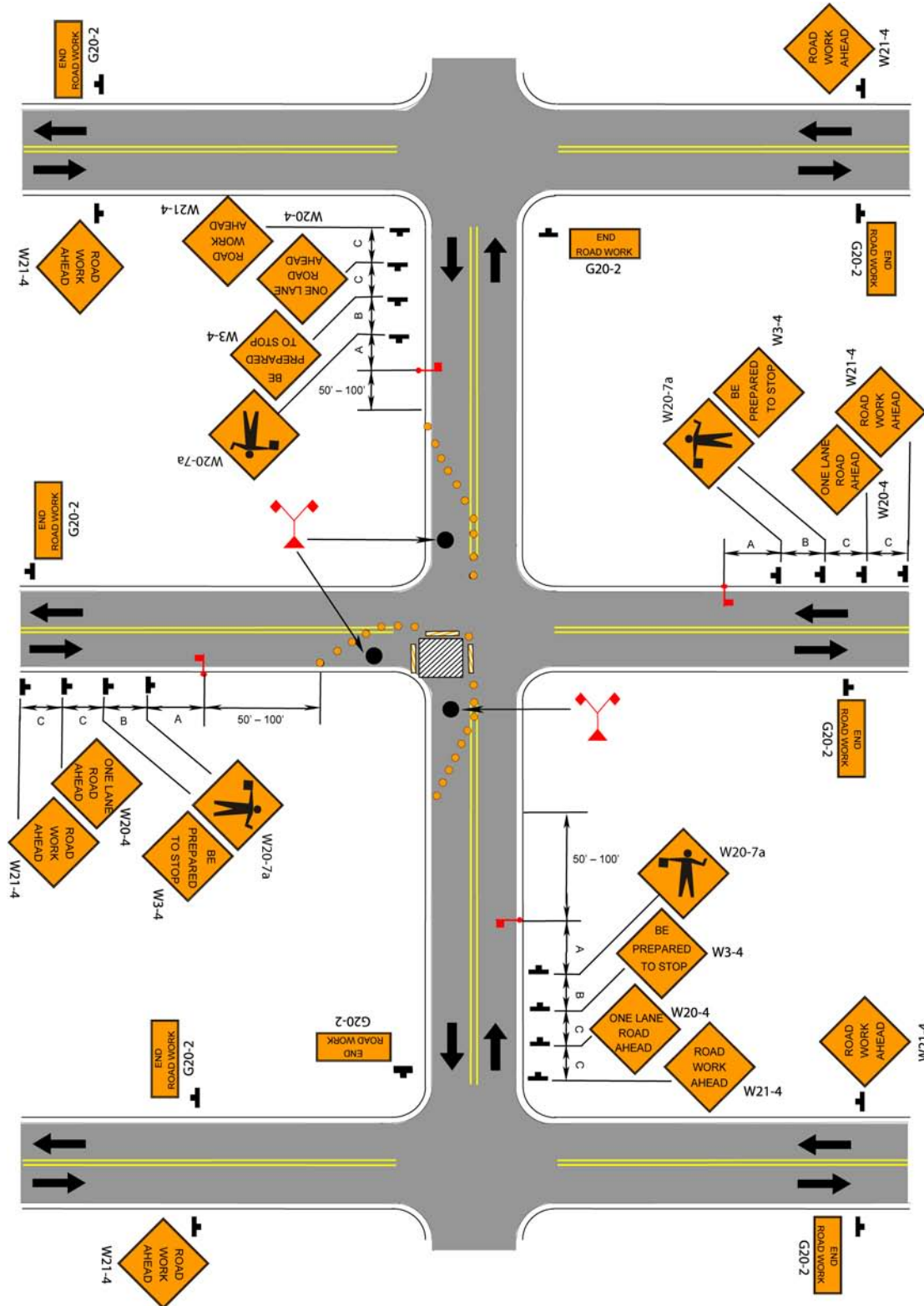

Figure 9-13. Typical Application: Closure at Side of Intersection (With No Parking Lanes)

**Notes for Figure 9-14**

The situation depicted may be simplified by closing one or more of the intersection approaches. If this cannot be done and/or when capacity is a problem, through vehicular traffic should then be directed to other roads or streets.

Turns can be prohibited as required by vehicular traffic conditions. Unless the streets are wide, it might be physically impossible to make certain turns, especially for commercial vehicles or buses.

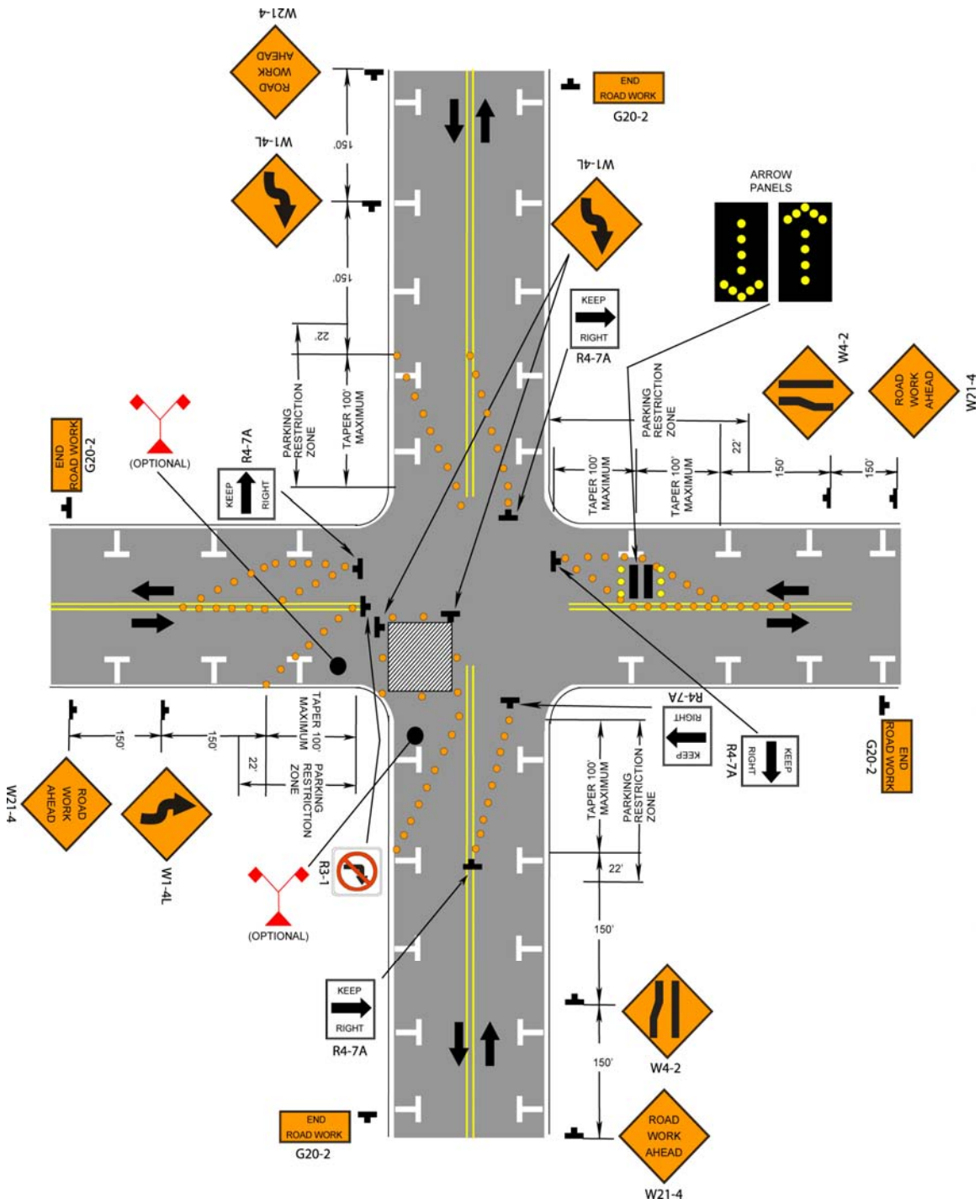

Figure 9-14. Typical Application: Closure at Side of Intersection (With Parking Lanes)

**Notes for Figure 9-15**

The closure of the adjacent interior lane in the opposing direction may not be necessary, depending upon the activity being performed and the work space needed for the operation.

Shadow vehicles with truck-mounted attenuators may be used.

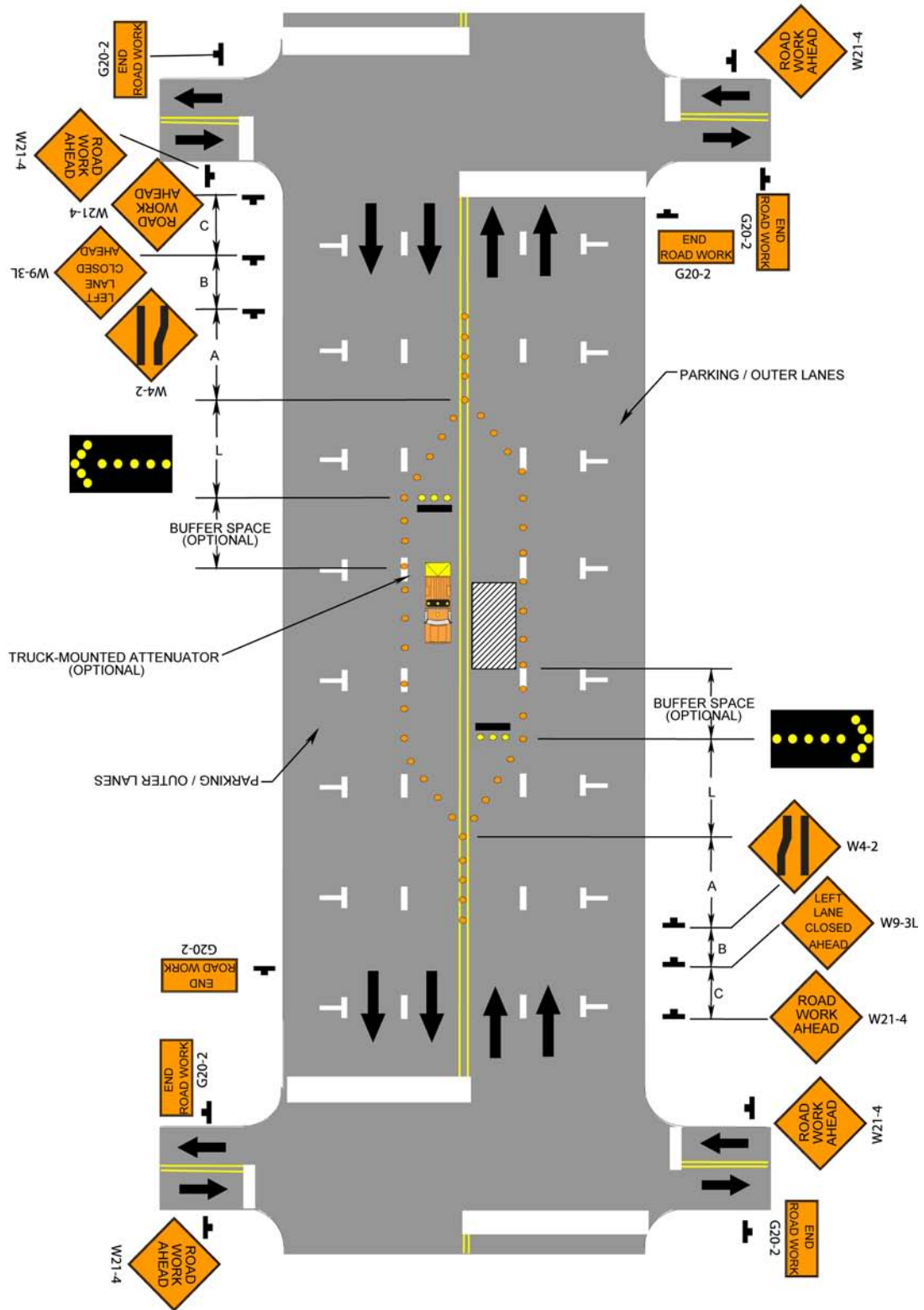

Figure 9-15. Typical Application: Interior Lane Closure on Multi-Lane Roadway or Street

**Notes for Figure 9-16**

Except for soft-term durations, temporary markings shall be provided to clearly delineate the temporary travel path. Pavement markings no longer applicable shall be removed or obliterated as soon as practical. For short-term situations where it is not feasible to remove and restore pavement markings, channelization shall be made dominant by using very close device spacing.

When channelization devices are used instead of pavement markings, the maximum spacing should be  $0.5 \times S$  feet, where  $S$  is the speed in mph.

If the tangent distance along the temporary diversion is more than 600 feet, a Reverse Curve sign, left first, should be used instead of the Double Reverse Curve sign, and a second Reverse Curve sign, right first, should be placed in advance of the second reverse curve back to the original alignment.

Minimum Lane widths for this application are 10 feet.

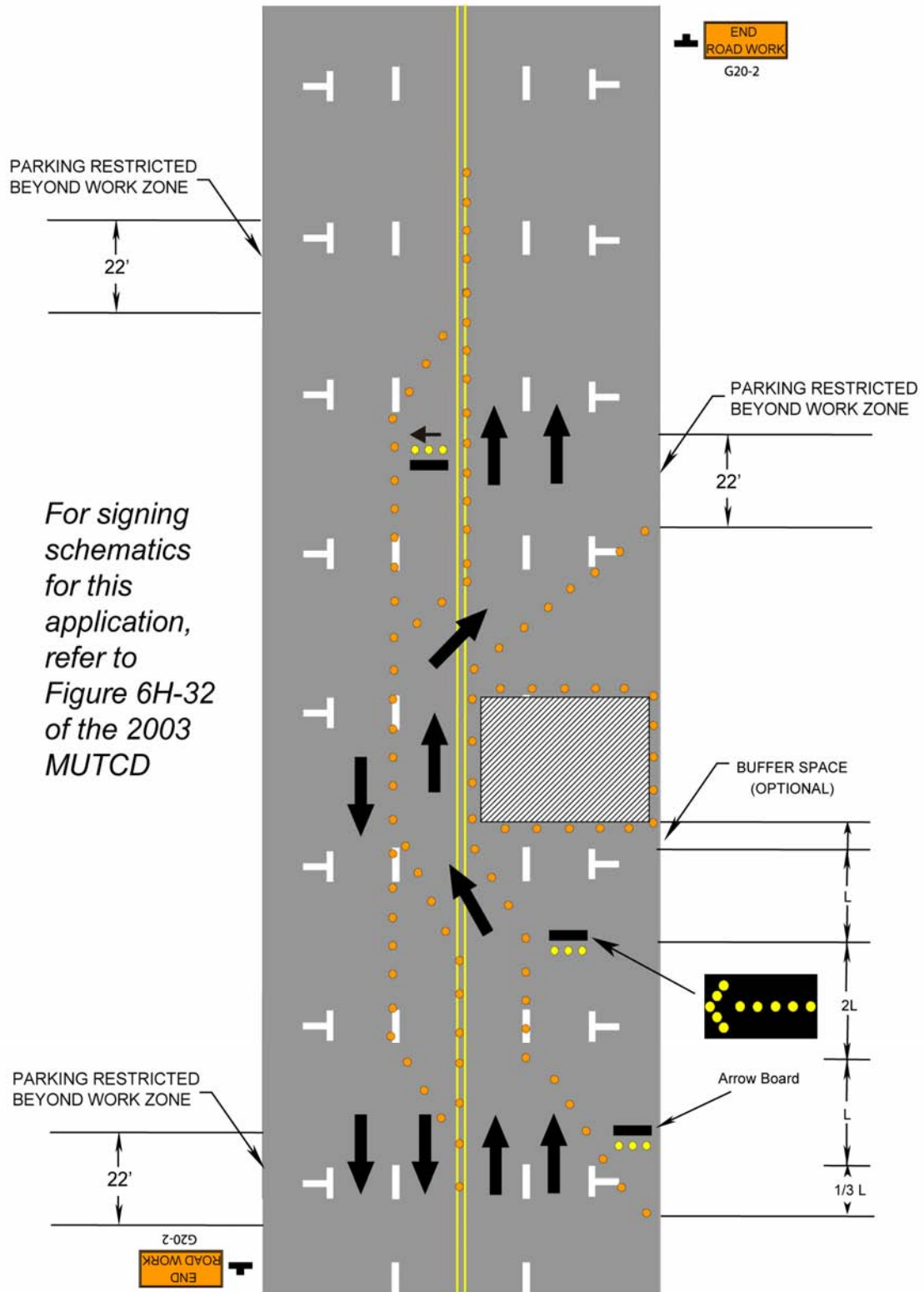

Figure 9-16. Typical Application: Merging Taper Followed by Shifting Taper on Multilane Road



**Notes for Figure 9-17**

A high-level warning device should be placed in the work space if there is sufficient room.

For short-term use on low-volume, low-speed roadways, with vehicular traffic that does not include heavy commercial vehicles or buses, a minimum of 10 feet may be used.

Unless the streets are wide, it may be physically impossible to turn left, especially for large vehicles. Left turns may be prohibited as required by geometric conditions.

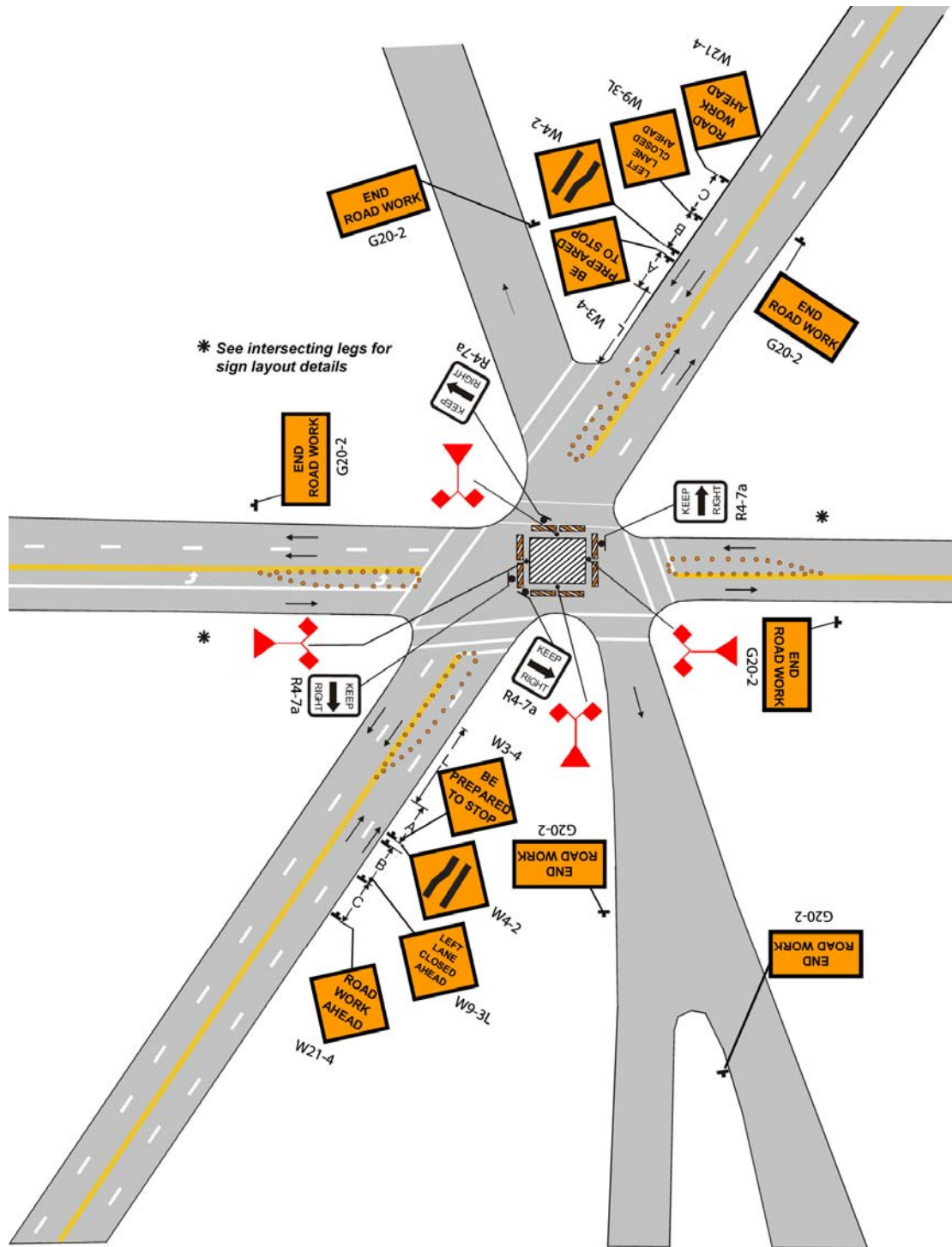

Figure 9-17. Typical Application: Multi-leg Intersection

**Notes for Figure 9-18**

When crosswalks or other pedestrian facilities are closed or relocated, temporary facilities shall be detectable (by pedestrians and motorists) and shall include accessibility features consistent with the feature present in the existing pedestrian facility.

Bypass Sidewalk Operations must account for use by wheelchairs or provide an alternate means of conveyance for pedestrians with disabilities.

Only the Temporary Traffic Control devices related to pedestrians are shown. Other devices, such as lane closure signing or ROAD NARROWS signs, may be used to control vehicular traffic.

Signs, such as KEEP RIGHT (or LEFT), may be placed along a temporary sidewalk to guide or direct pedestrians.

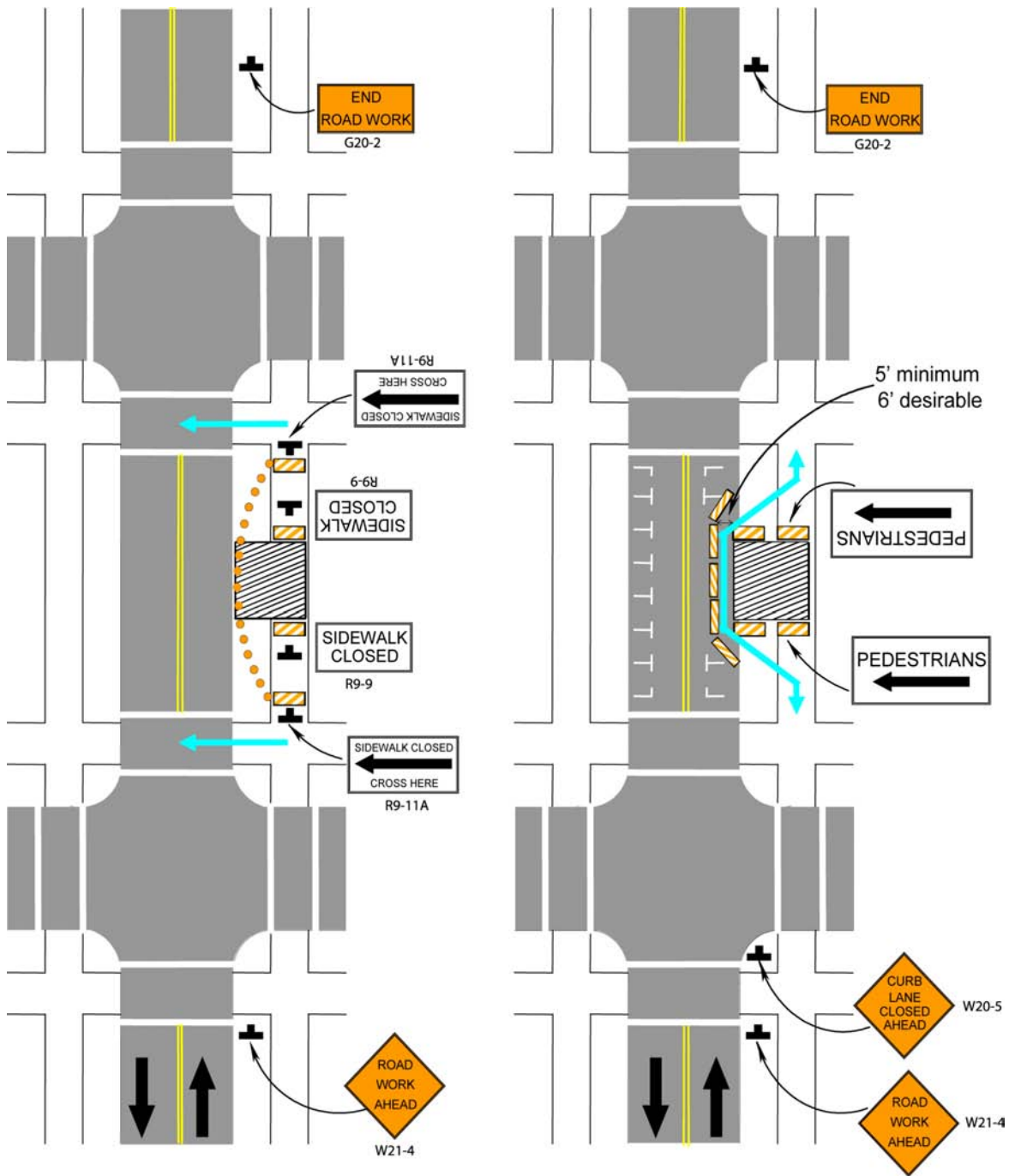

Figure 9-18. Typical Application: Sidewalk Closure and Bypass Sidewalk Operation

**Notes for Figure 9-19, Figure 9-20 and Figure 9-21**

When crosswalks or other pedestrian facilities are closed or relocated, temporary facilities shall be detectable (by pedestrians and motorists) and shall include accessibility features consistent with the feature present in the existing pedestrian facility.

Curb parking shall be prohibited for at least 50 feet in advance of the mid-block crosswalk.

Only the Temporary Traffic Control devices related to pedestrians are shown. Other devices, such as lane closure signing or ROAD NARROWS signs, may be used to control vehicular traffic.

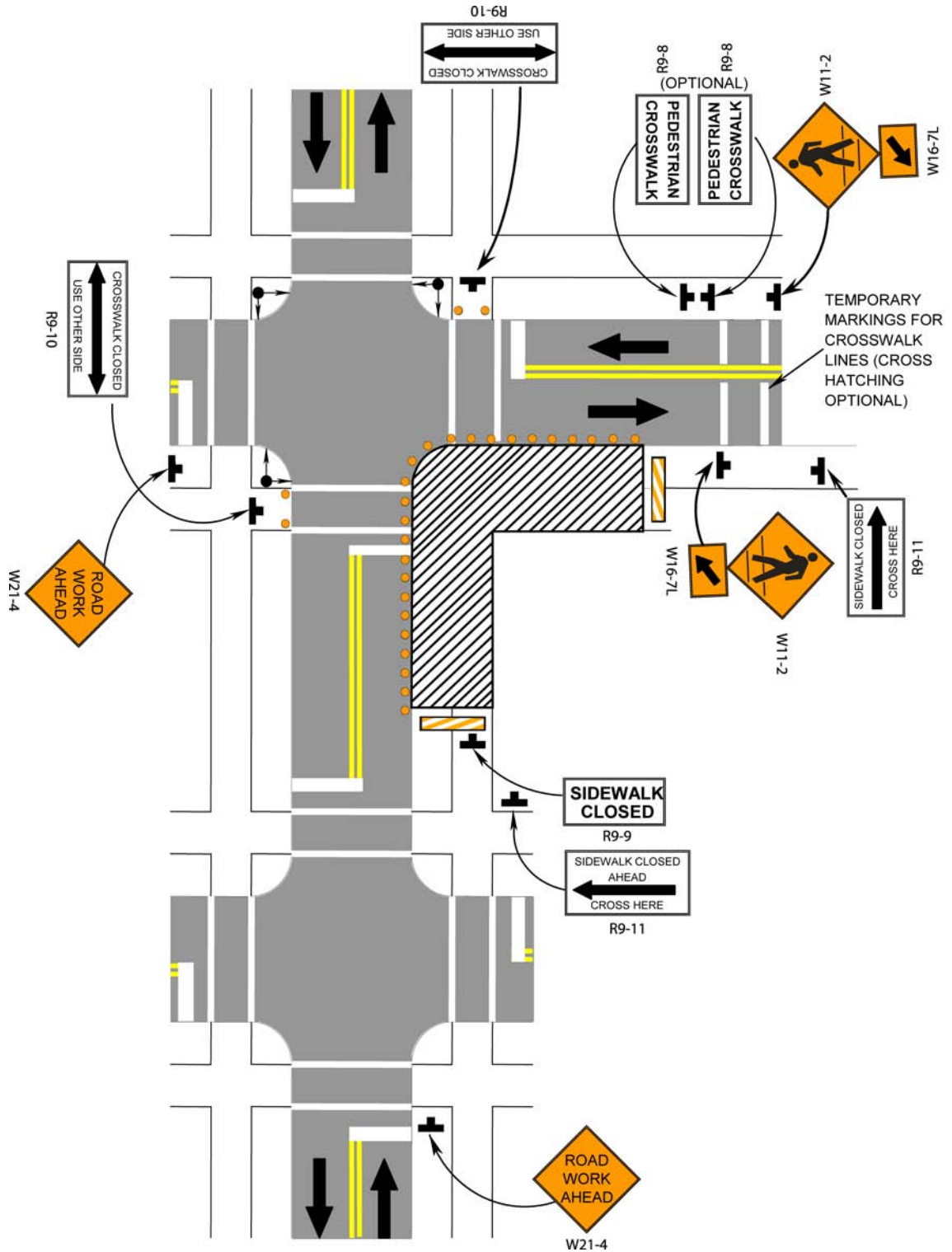

Figure 9-19. Typical Application: Crosswalk Closures and Pedestrian Detours

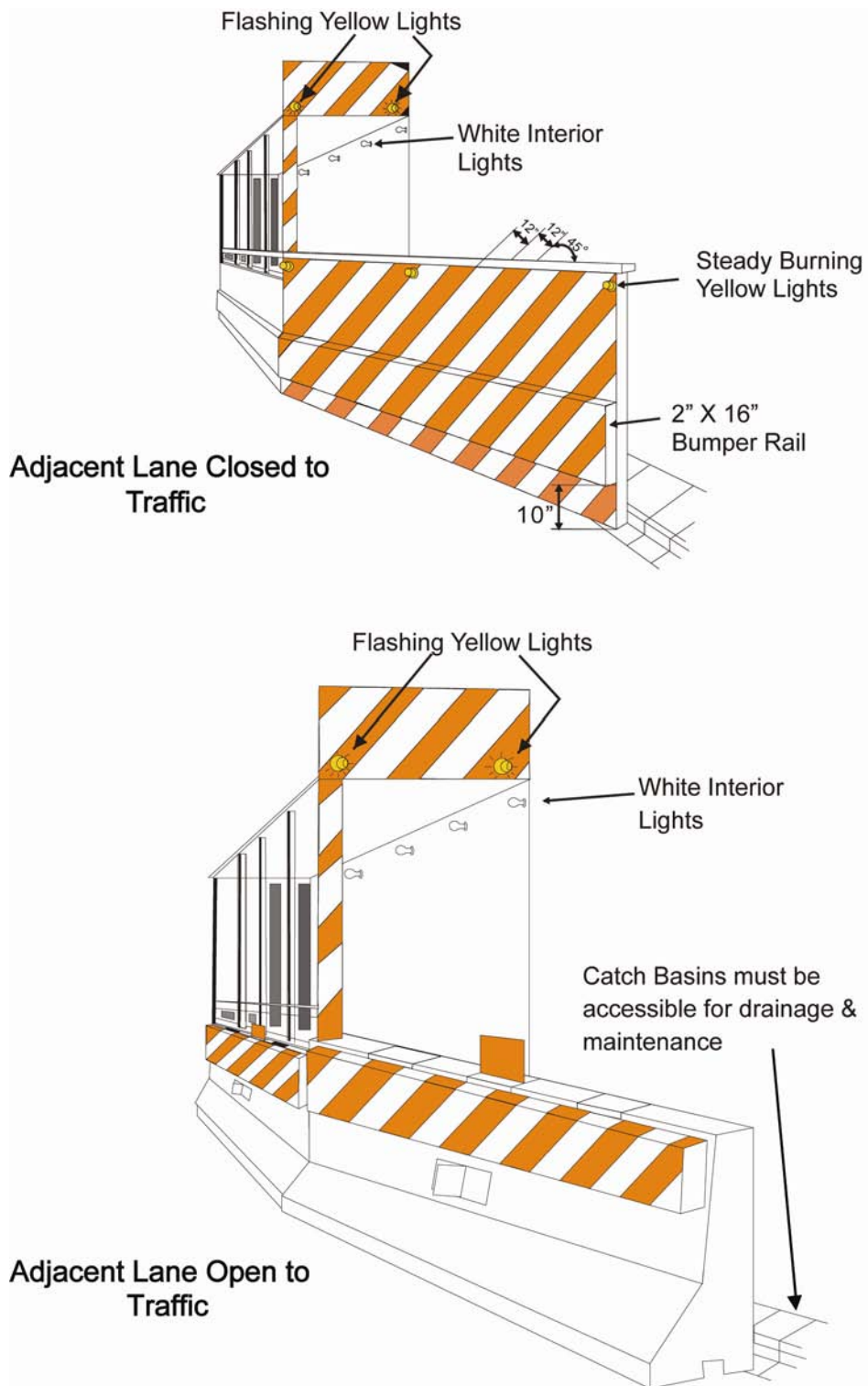
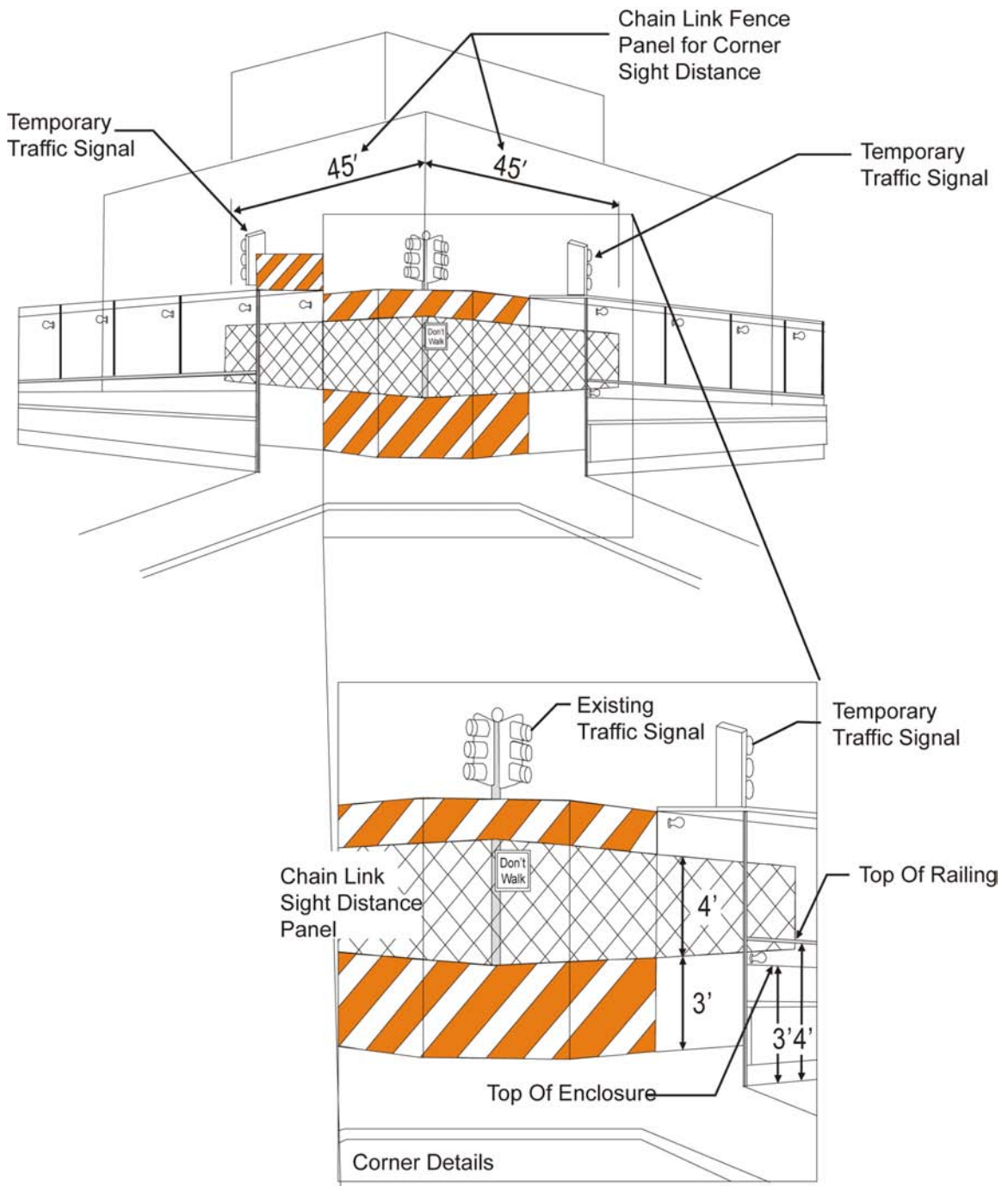

Figure 9-20. Typical Application: Covered Pedestrian Walkways – Midblock Locations



**Figure 9-21. Typical Application: Covered Pedestrian Walkways – Corner Locations at Four-Way Intersections**



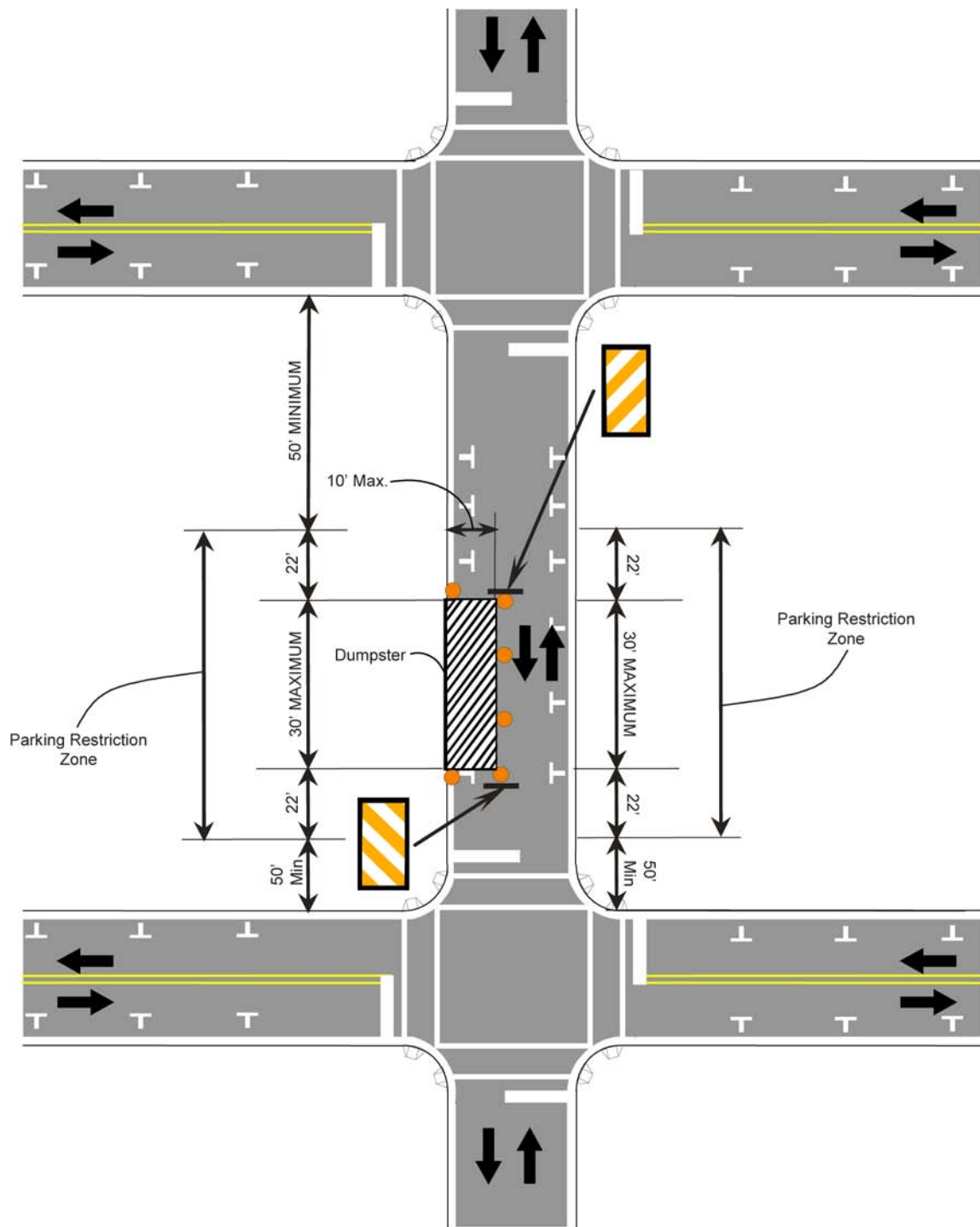

Figure 9-22. Typical Application: Construction Dumpster Located in Parking Lane (Two-Way Road)

**Notes for Figure 9-22, Figure 9-23 and Figure 9-24**

When placing a dumpster, it must be set back a minimum of 50 feet from the corner of both adjacent intersection approaches.

1. For all dumpster permit requests exceeding 14 days, using the third party system, the application permit shall be sent electronically or by fax to DDOT Traffic Services Administration for approval.
2. For all Crane permit requests for more than three consecutive days, DDOT Public Space Administration shall electronically notify DDOT TSA immediately with a copy of the permit or by fax and application.

Dumpsters are permitted on the main thoroughfares (commuter routes) from 9:30 a.m. to 3:00 p.m. and 10:00 p.m. to 5:00 a.m. ONLY. If the roadway is marked with “NO STANDING / NO PARKING ANYTIME” or “NO STOPPING 7 am to 9:30 am and 4 pm to 6:30 pm MONDAY – FRIDAY NO PARKING ALL OTHER TIMES” signs, dumpsters are not allowed any time.

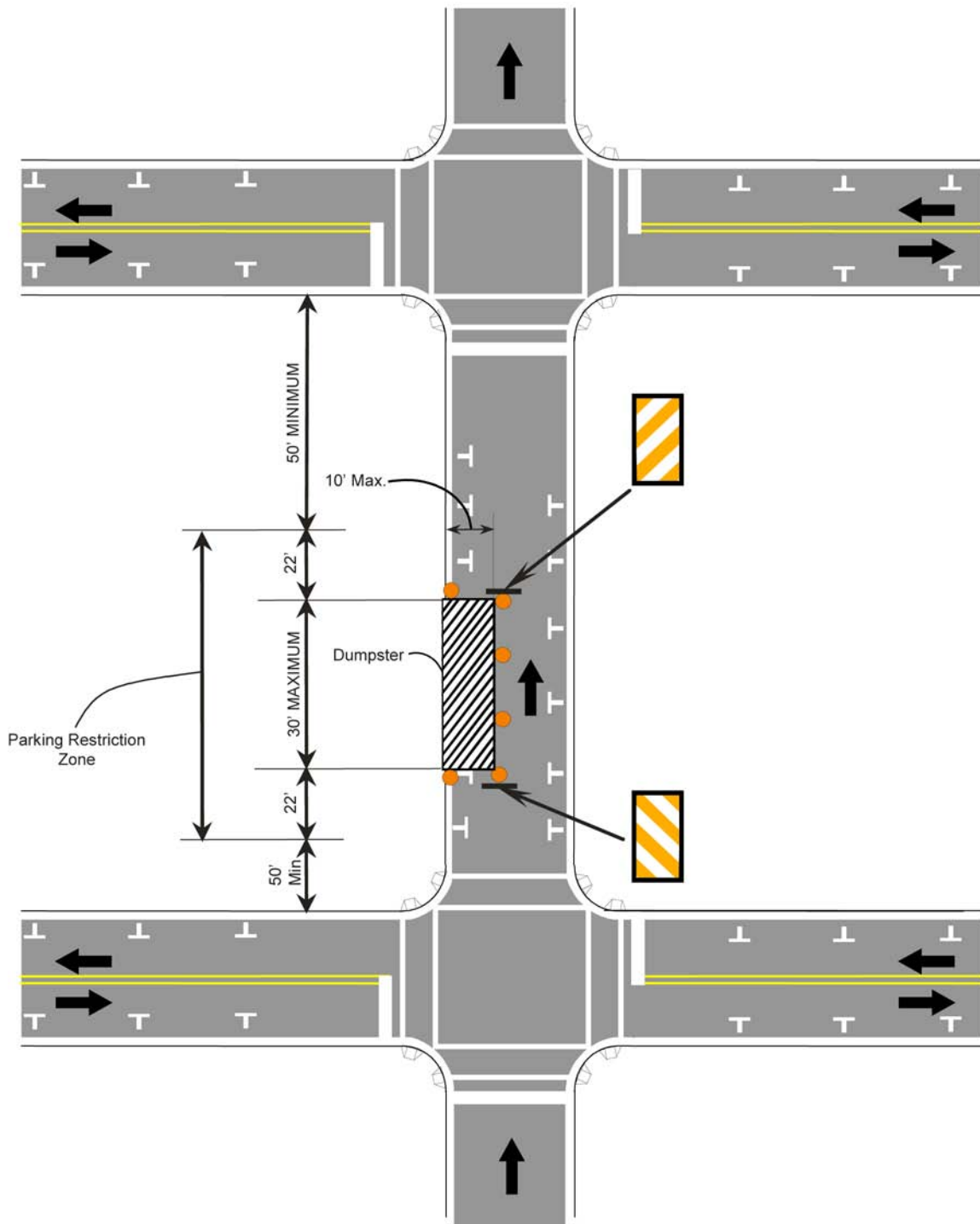
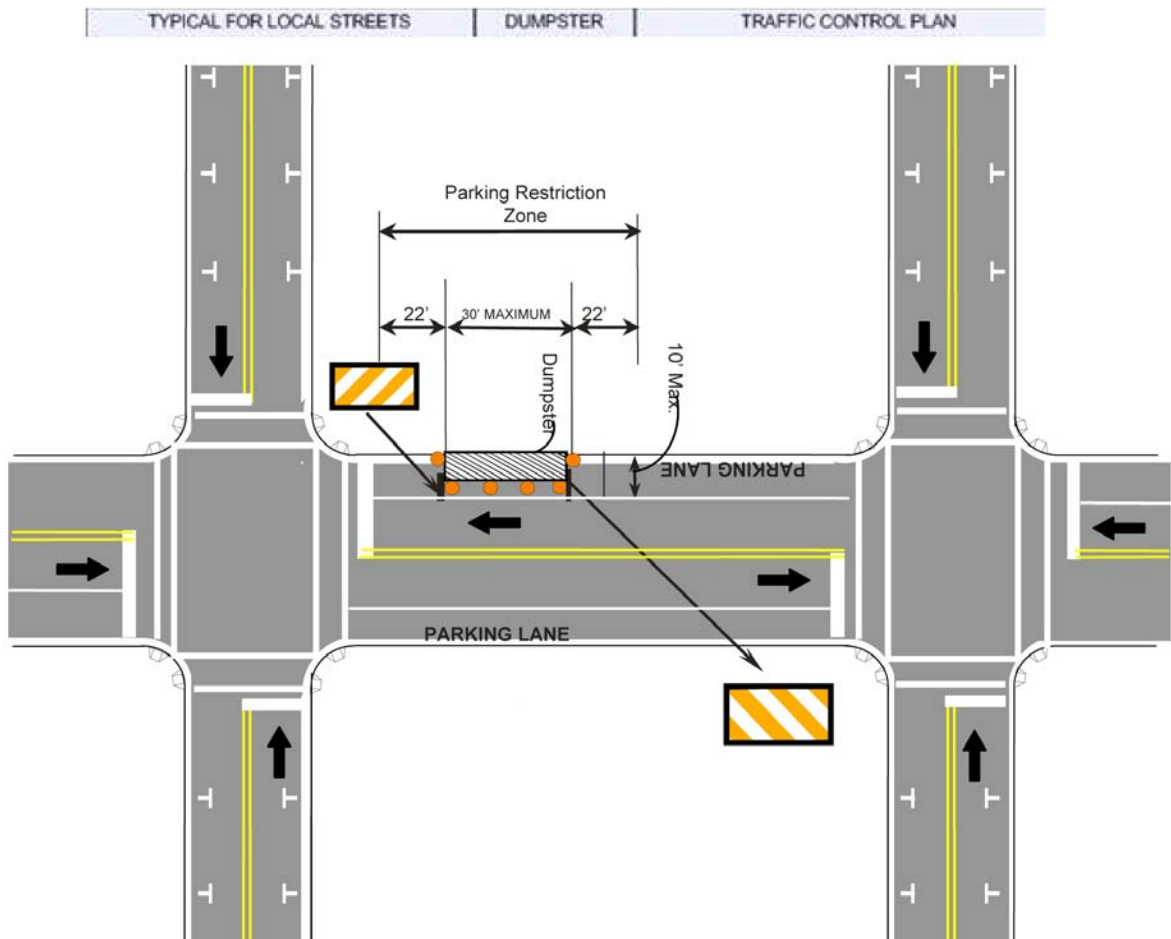

Figure 9-23. Typical Application: Construction Dumpster Located in Parking Lane (One-Way Road)



**\*DUMPSTERS IN PARKING LANE ONLY**

**PLEASE label or indicate the following on Traffic Control Plan(s).**

**Label: N/A if not applicable**

1. Direction of travel on each street.
2. Number of lanes in each direction.
3. Actual location of dumpster.
4. Available parking on both sides of street.
5. Location of 36 inch high reflective cones.
6. Indicate names of all cross streets.
7. Indicate name of street of work site.
8. Meter information (number, count) \_\_\_/\_\_\_
9. Location of pedestrian control signage.
10. Notification to affected residents, police, fire and businesses.
11. Add pavement markings and existing signs.

**RESTRICTIONS:**

**WHEN PLACING A DUMPSTER IT MUST BE SET BACK 50FT. FROM THE CORNER FOR BOTH APPROACHES**

**Figure 9-24. Typical Application: Construction Dumpster Located in Parking Lane**

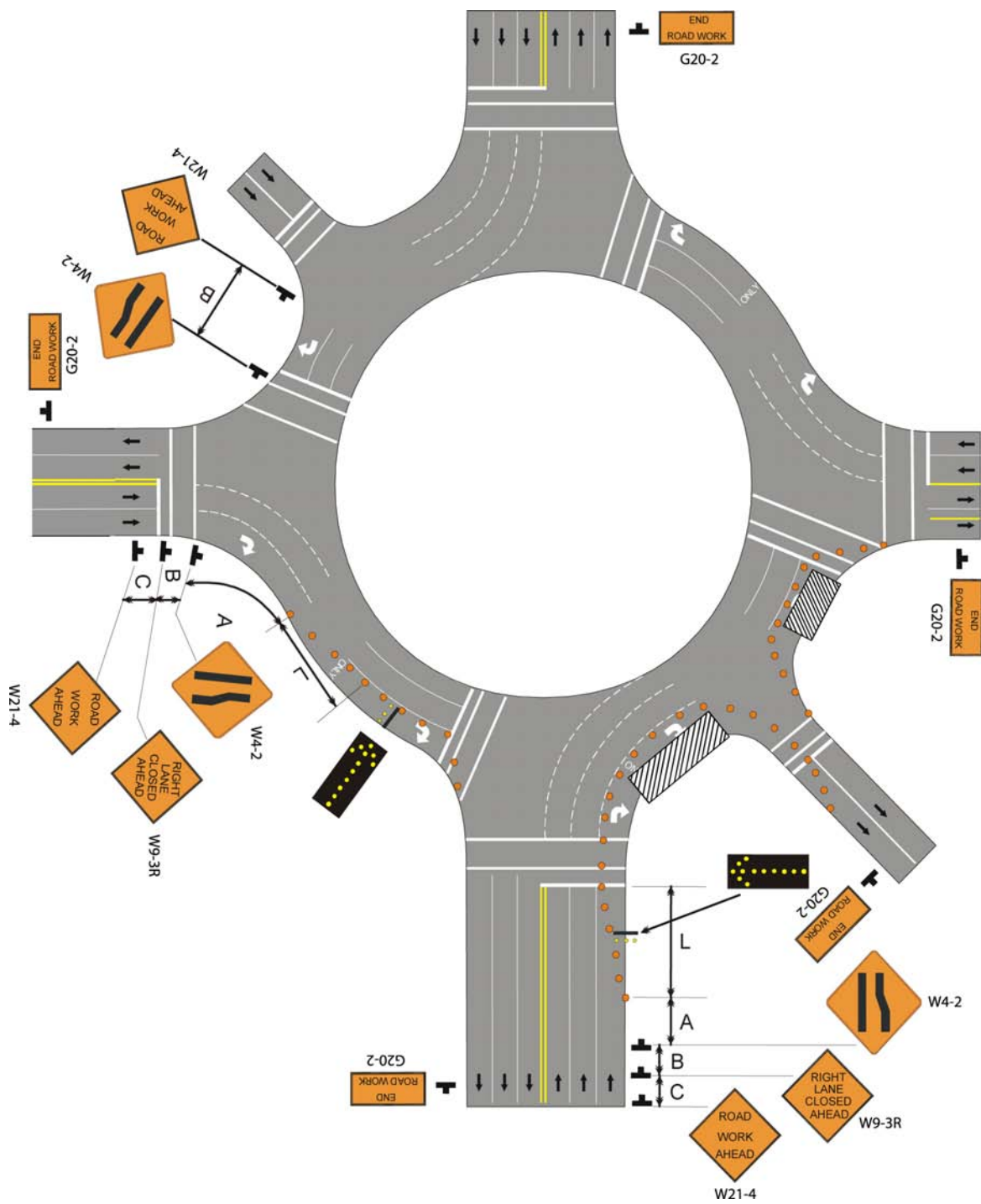

Figure 9-25. Typical Application: Traffic Circle with Outer-most Lane Closure

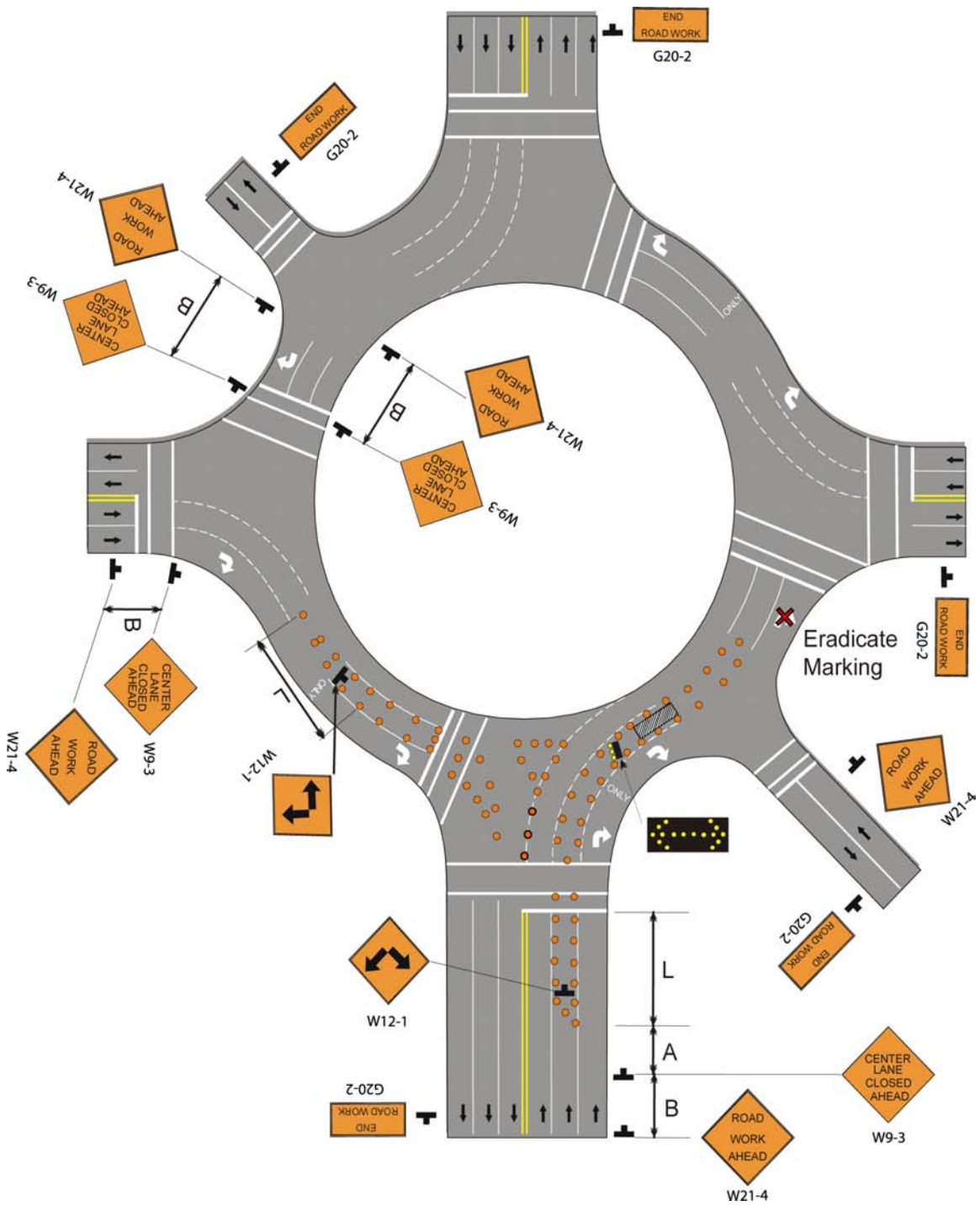

Figure 9-26. Typical Application: Traffic Circle with Center Lane Closure

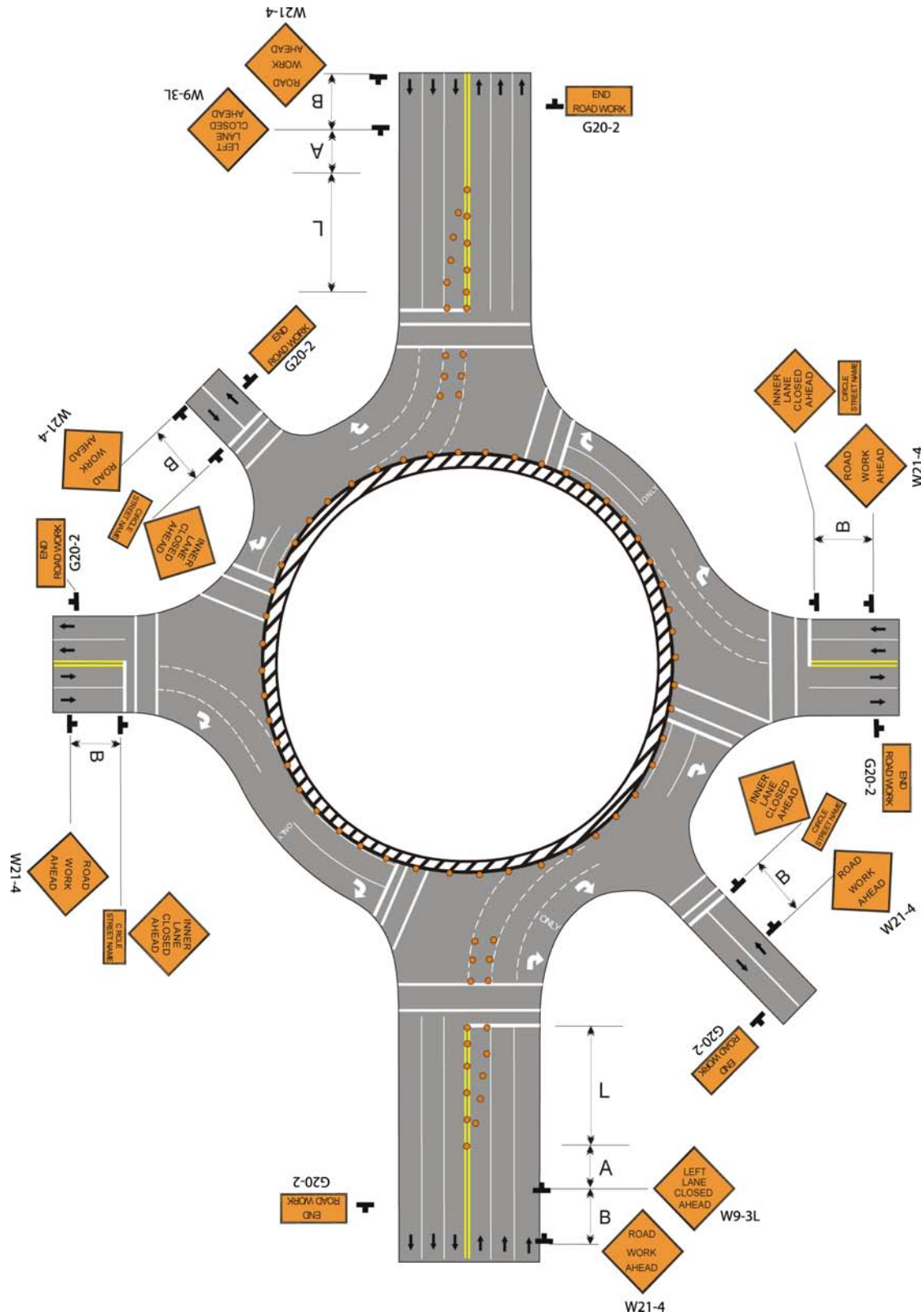

Figure 9-27. Typical Application: Traffic Circle with Inner-most Lane Closure

## **SECTION 10 – CRANE TYPICAL DETAILS**

Support:

Compared to other types of construction equipment, mobile cranes typically occupy relatively large workspaces in three dimensions (3D) during an operation. The workspaces of cranes are to be taken into account carefully prior to their operation to reduce the potential for spatial conflicts between cranes and other components such as building structures, other pieces of equipment, and temporary facilities located within their close proximity resulting in hazardous work conditions. This chapter provides guidance on the crane details for crane workspace considerations and the crane typicals for lane closures.

**Standard:**

**For all crane permit requests for more than three consecutive days, DDOT Public Space Administration shall electronically notify DDOT TSA immediately with a copy of the permit or by fax and application.**

### **10.1 CRANE SIZE**

Support:

Considerations for crane selection should include the weights, dimensions and lift radii expected, the type of lifting to be done, the serviceability of the equipment and the site conditions.

Various sizes of cranes:

1. 40 Ton Crane
2. 50 Ton Crane
3. 70 Ton Crane
4. 120 Ton Crane
5. 150 Ton Crane
6. 220 Ton Crane

When using a particular crane, state the reason why this crane is used over another type of crane size.



**Standard:**

**Restrictions in using a 220 ton crane:**

- **Street must have a minimum width of 50 feet to accommodate radius of crane.**
- **Entire street must be closed within the block where crane is to be used.**
- **Prepare a traffic control plan to detour traffic around this block.**
- **Sidewalk must be closed to pedestrians within work area.**
- **Traffic control plan must be tailored to fit contractor's specific situation.**
- **Permit invalid: If all required dimensions are not shown.**

**For cranes 220 tons and above, a special use permit is required.**

## 10.2 CRANE TYPICALS

Support:

The diagrams on the following pages represent examples of the application of principles and procedures for safe and efficient traffic control in temporary traffic control zones and are not intended to be standards. It is not possible to include illustrations to cover every situation which will require work area protection. These typical layouts are not intended as a substitute for engineering judgment and should be altered to fit the conditions of a particular site. Contractor plans or other agency documents may also have applicable layouts to be followed.

The diagrams are not to scale, and the number of channelizing devices shown may not be the number needed at the work site. The tables on the typical applications are to be used to determine taper and buffer lengths, using Section 7 for guidance on the spacing and number of devices.

Notes and tables found throughout Section 10 provide information for the development of temporary traffic control zones. Read all notes before using these diagrams.

In general, the procedures illustrated represent minimum solutions for the situations depicted. For further information, refer to Part 6 of the MUTCD. It contains the standards for work zone traffic control, including sign type numbers and dimensions of signs..

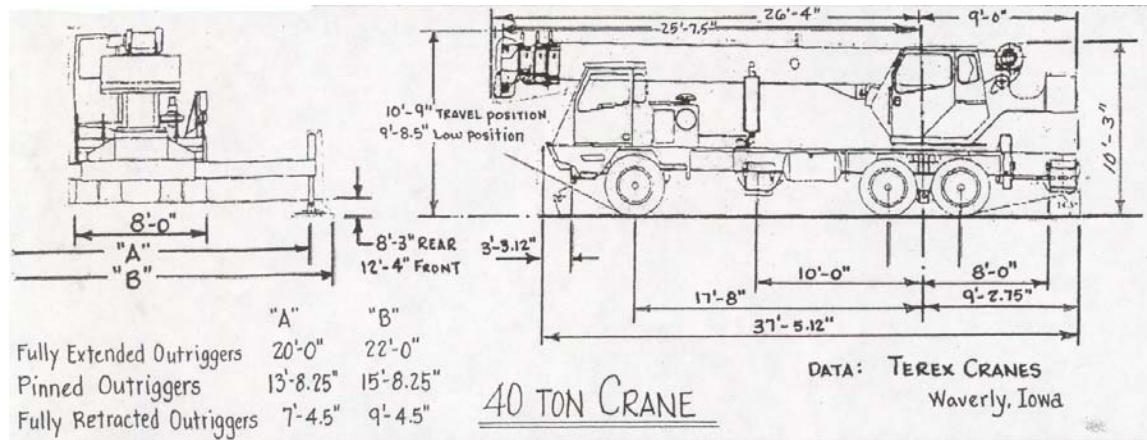

Figure 10-1. Typical Details for 40 Ton Crane

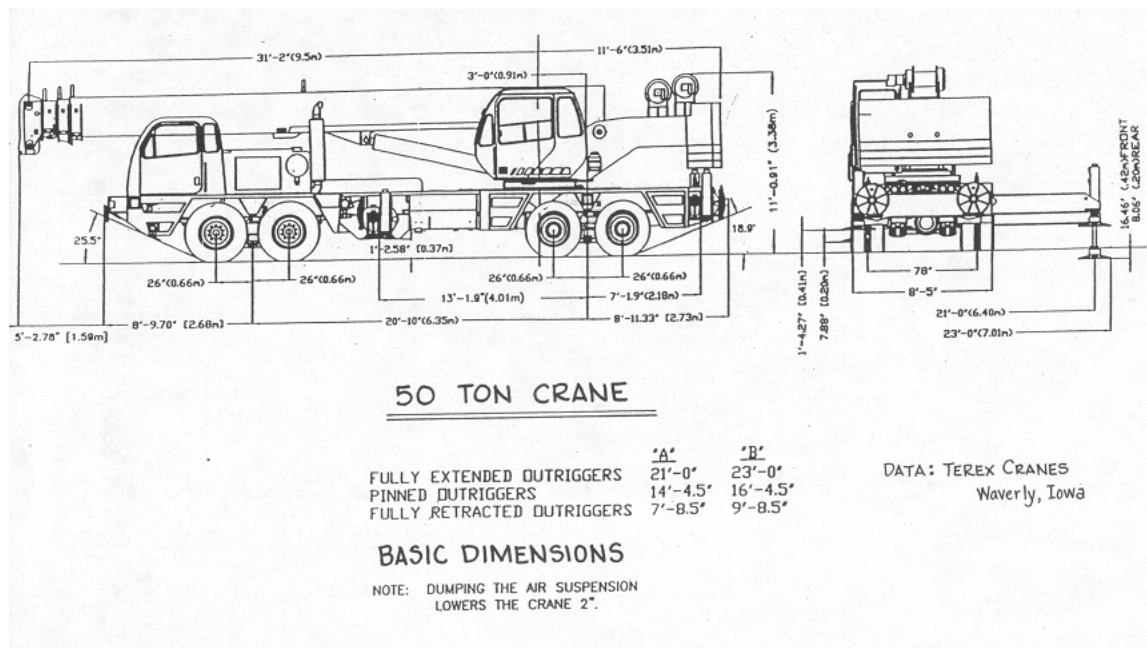

Figure 10-2. Typical Details for 50 Ton Crane

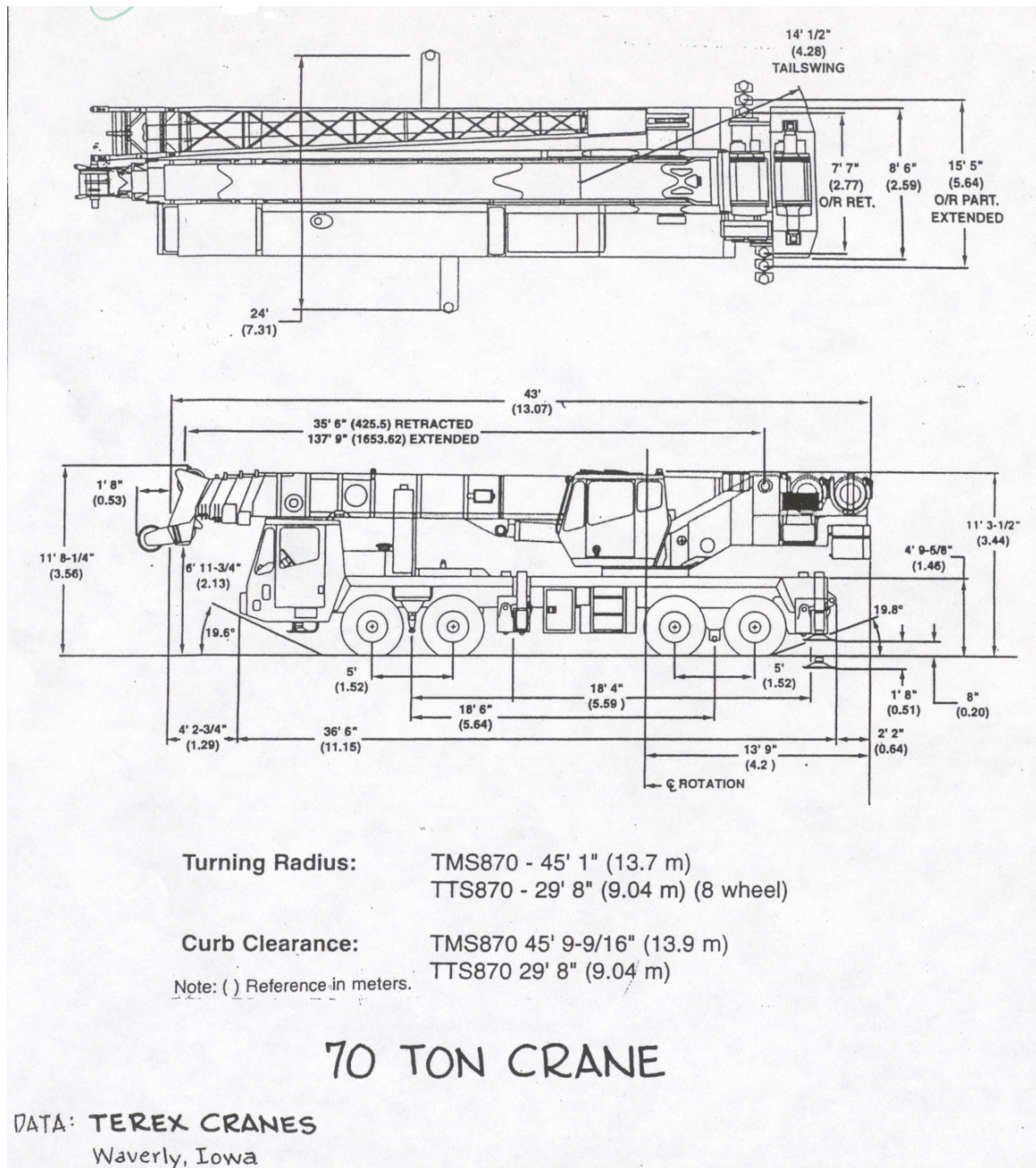

Figure 10-3. Typical Details for 70 Ton Crane

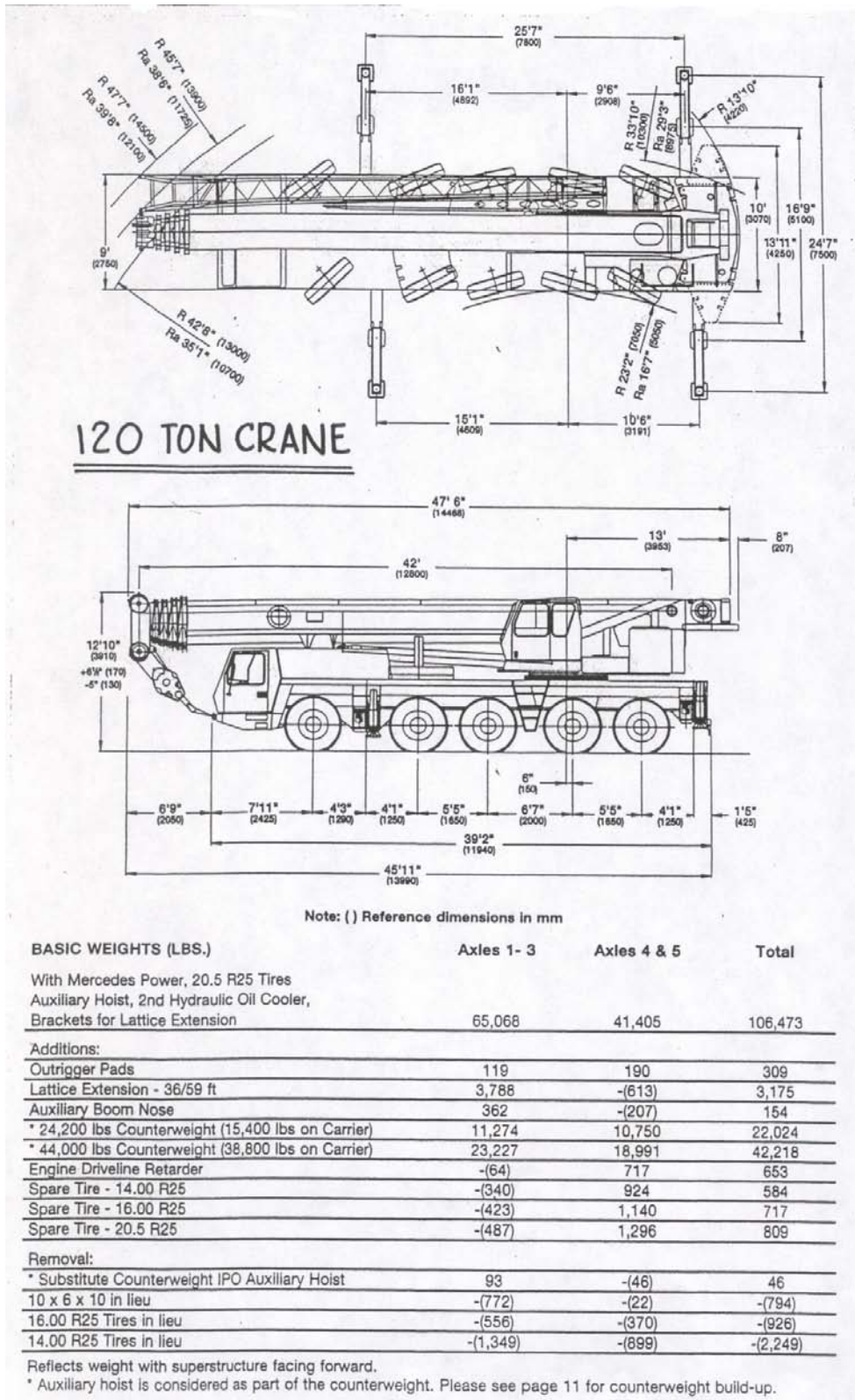

Figure 10-4. Typical Details for 120 Ton Crane

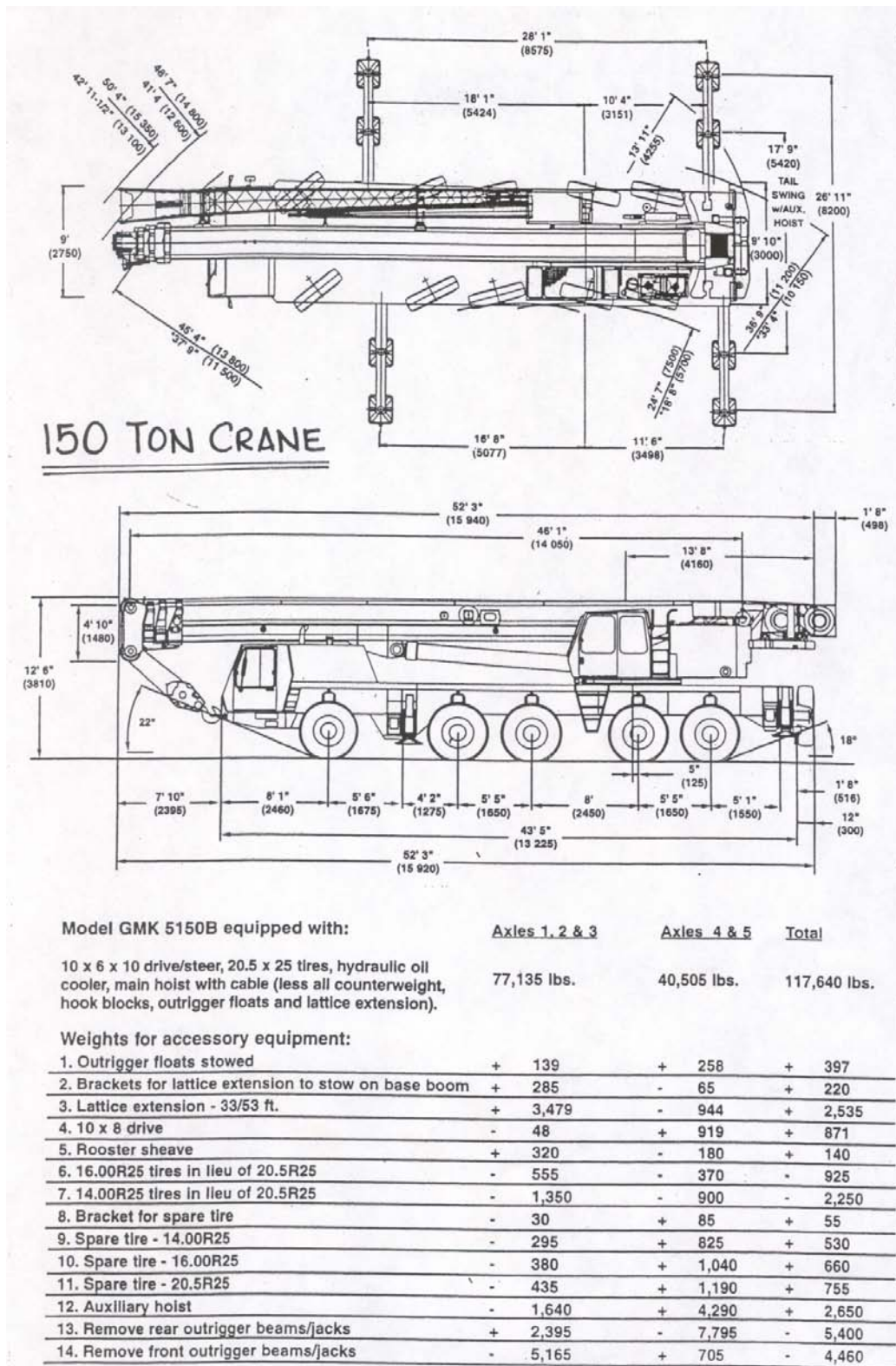

Figure 10-5. Typical Details for 150 Ton Crane

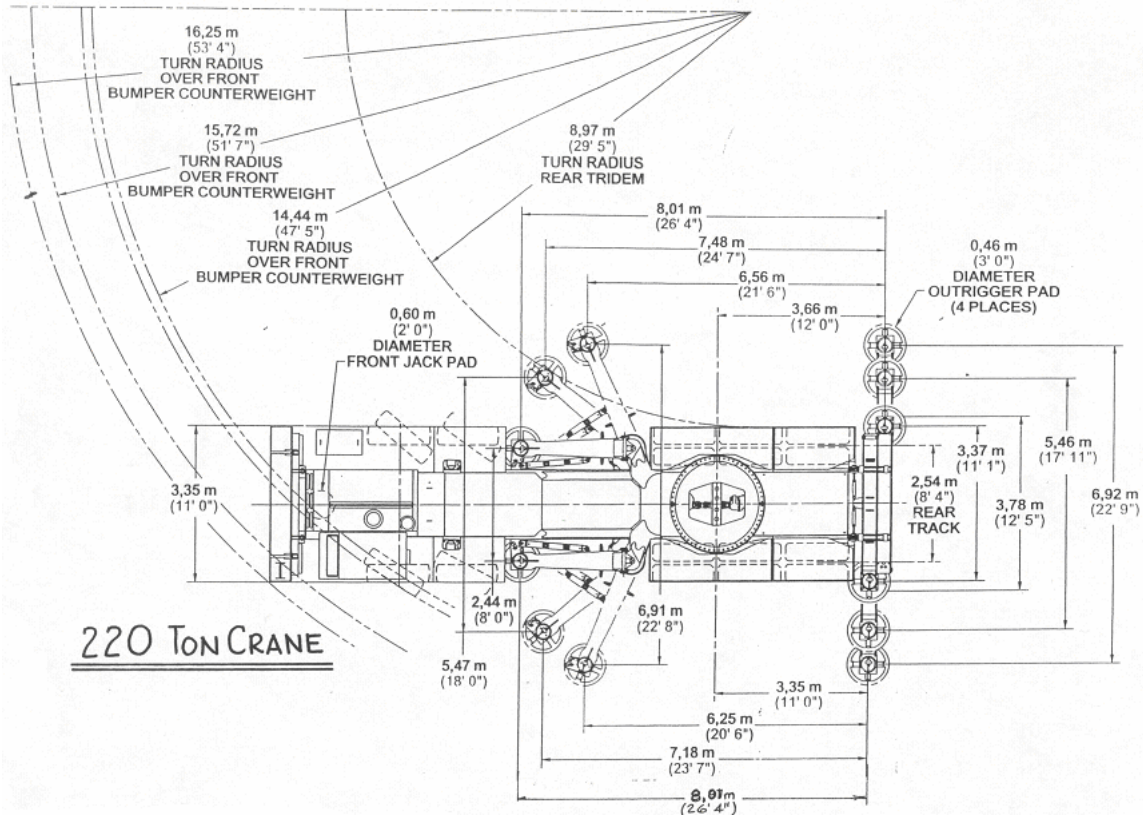

Figure 10-6. Typical Details for 220 Ton Crane

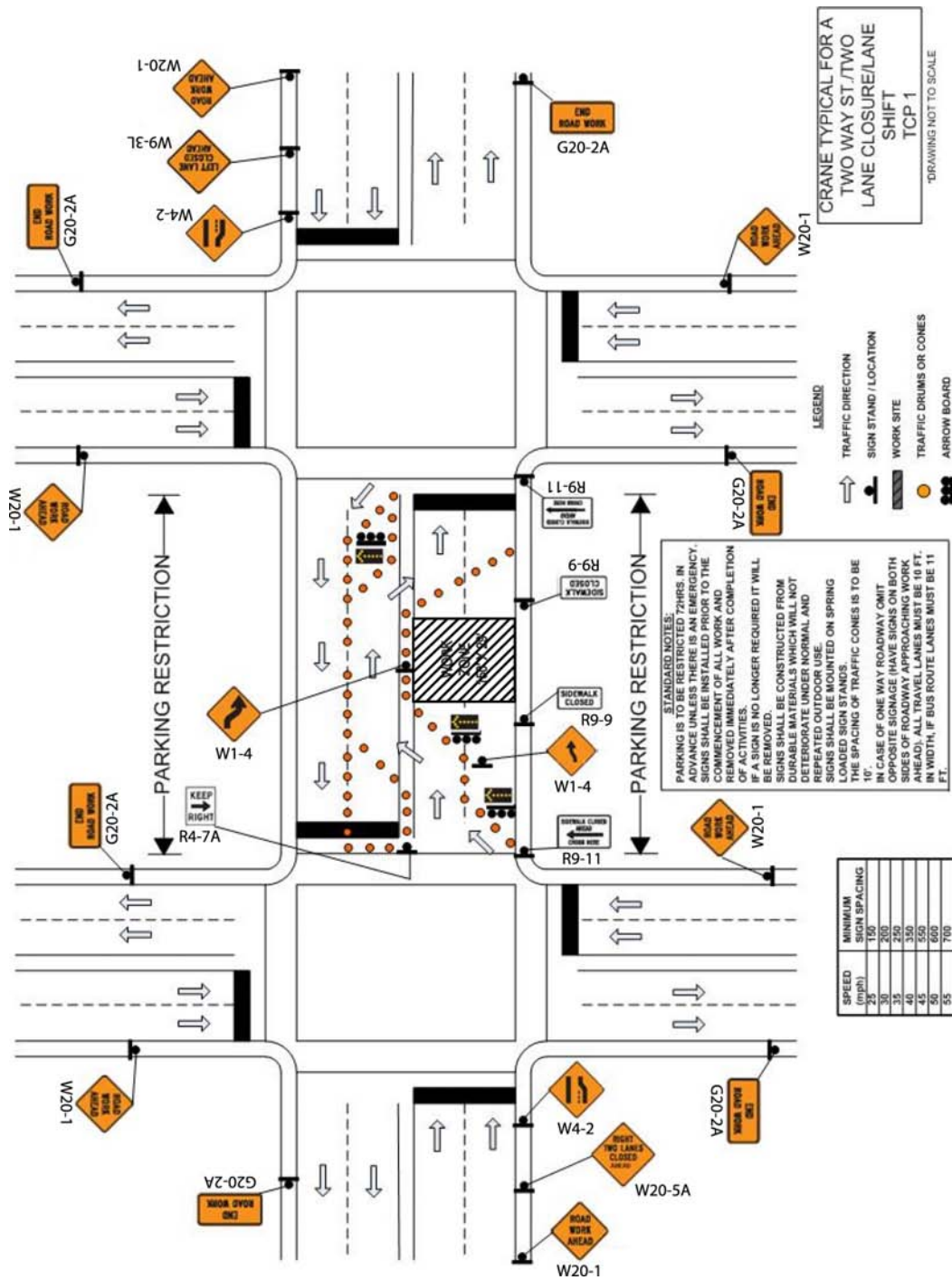

Figure 10-7. Crane Typical for a Two-Way St./Two Lane Closure/Lane Shift TCP 1



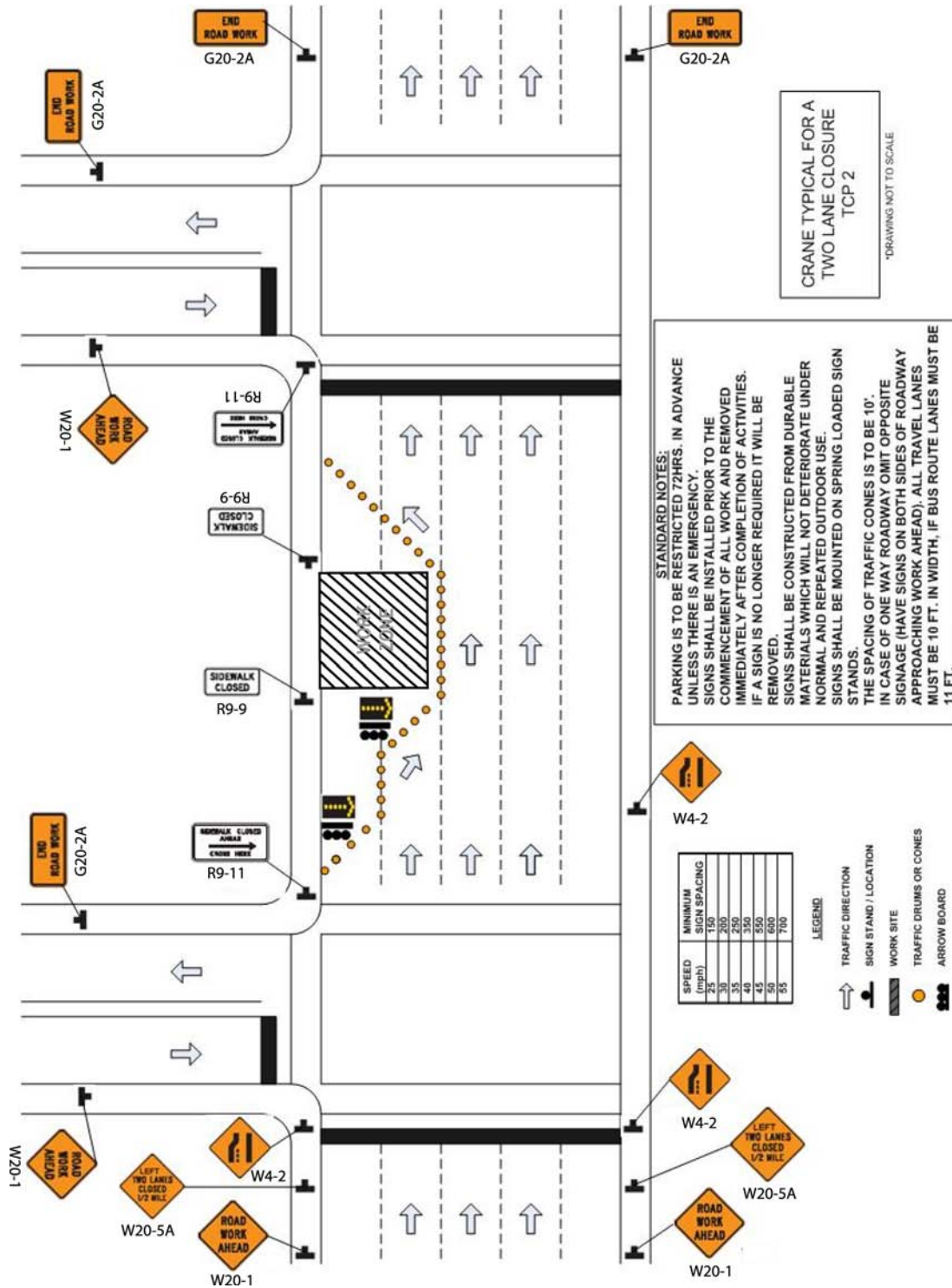

Figure 10-8. Crane Typical for a Two Lane Closure TCP2

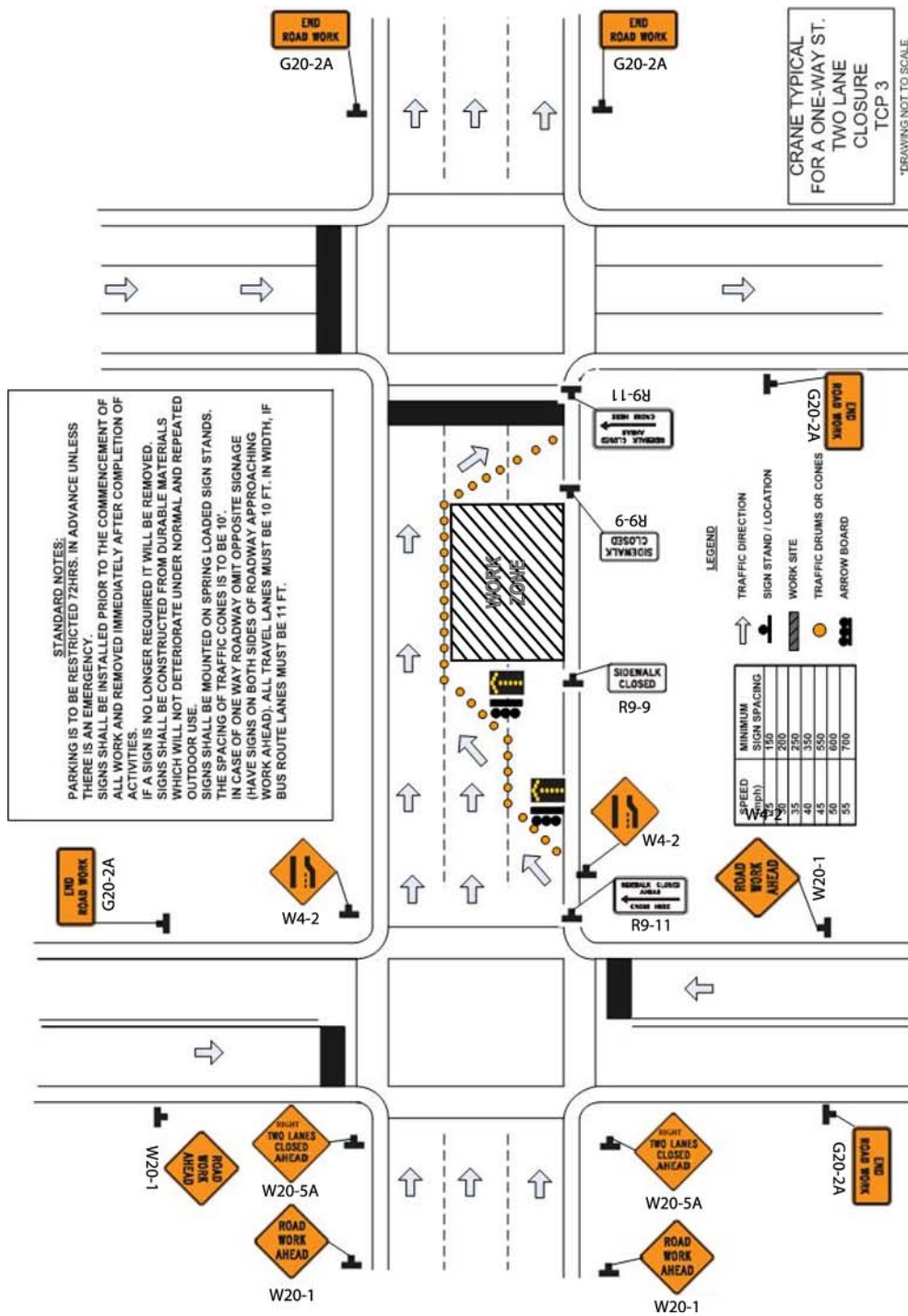

Figure 10-9. Typical Details for a One-Way St. Two Lane Closure TCP 3

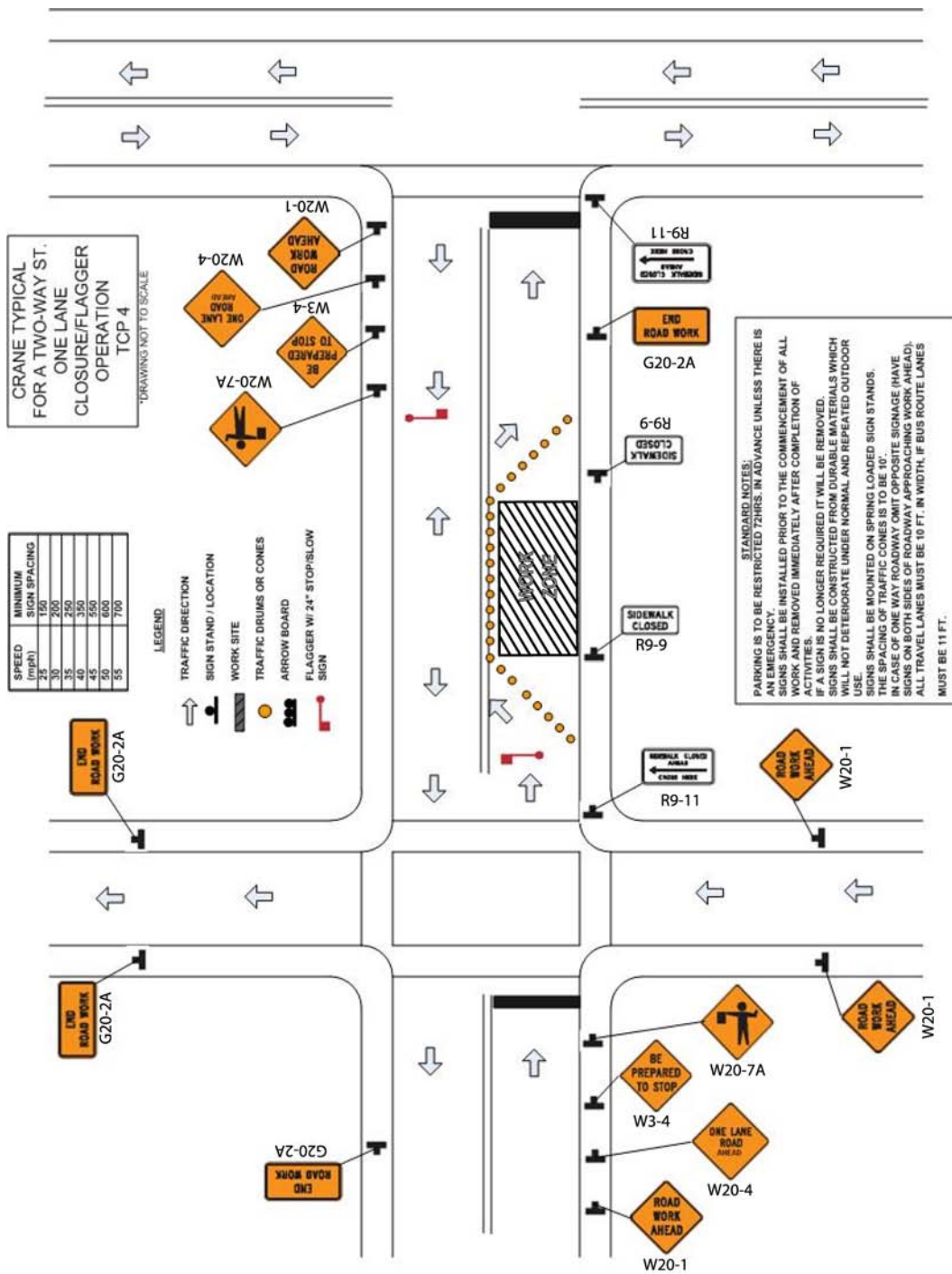

Figure 10-10. Typical Detail for a Two-Way St. One Lane Closure/Flagger Operation TCP 4

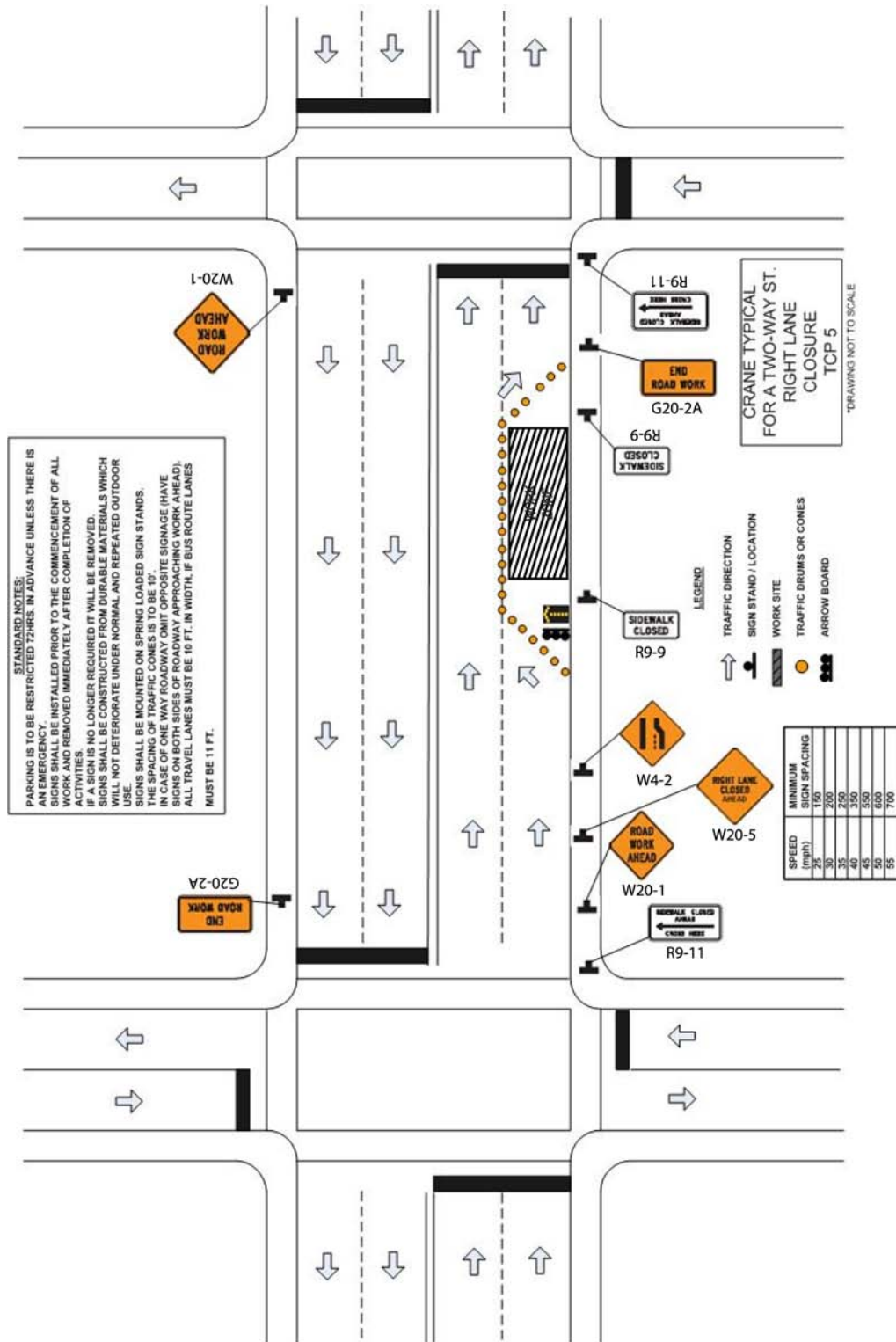

Figure 10-11. Crane Typical for a Two-Way St. Right Lane Closure TCP 5

## **APPENDICES**



**APPENDIX A****THE FUNCTIONAL CLASSIFICATION OF STREETS IN THE  
DISTRICT OF COLUMBIA****Purpose or Functional Classification**

The roadway network in the District of Columbia is arrayed into a system of categories that represent the use and function of each street. This system is called the Functional Classification of Streets. The functional categories range from Principal Arterials, which are major traffic carriers in the city, to Local Streets, which serve predominantly local traffic and carry little to no through traffic. The street network is classified for a number of reasons. The primary reason is to assure that street improvement funds are allocated in a manner that ensures that those streets that are most important in maintaining the daily flow of people and goods throughout the city are given priority for construction funding. The classifications also play an important role in traffic planning. A goal of traffic planning is to funnel as much traffic as possible onto the major arteries in the city and discourage traffic from using the narrow neighborhood streets that comprise the major portion of the city network. The classification system details the extent to which streets are functioning as traffic carriers and is therefore used as a framework for planning such improvements as traffic signalization channelizations and various sign and pavement marking details. These classifications can be used in determining which streets are candidates for traffic restraints.

**Description of Functional Categories**

The street network is split into four categories and three sub-categories. They are:

- A) Principal Arterial System
  - 1) Interstate Highways
  - 2) Other Freeways and Expressways
  - 3) Other Principal Arterials
- B) Minor Arterials
- C) Collectors
- D) Locals

A brief description of each category and/or the common characteristics of streets in each category follows:

**Principals/Interstate Highway** - These roadways are the District's portion of the National System of Interstate Highways and as such are defined by the U.S. DOT standards. They are controlled access highways with wide lanes, full shoulders, flat grades, and long curves that are designed to carry heavy volumes of traffic. They are expected to carry interstate traffic into, through, or around the city, depending on the destination of the trip. The Interstate system that serves mostly trips destined into and out of the city. A typical D.C. Interstate Highway is the Southwest/Southeast Freeway, which has eight lanes and carries over 100,000 vehicles per day.

**Principals/Other Freeways and Expressway** - These are controlled access roadways that are not built to Interstate standards. They have multiple lanes, a minimum of traffic signals, no parking, and provide no direct access to any abutting land. Their sole purpose is to carry traffic. An example of this classification is Kenilworth Avenue, N.E., which is a limited access roadway that carries approximately 90,000 vehicles per day.

**Other Principal Arterials** - These streets are the primary, non-freeway traffic carriers in the city. They provide the linkage for the District with the surrounding jurisdictions and beyond and also provide the connections for major cross-town and intra-city movements.

The characteristics common to these streets are:

- 1) provide continuity with the regional roadway network
- 2) accommodate major radial and cross-town traffic movements
- 3) serve major bus and truck movements
- 4) carry the longest trips
- 5) traffic movement is the primary service function
- 6) provide two or more traffic lanes in the peak direction during rush hours
- 7) carry substantial off-peak traffic
- 8) average daily traffic exceeds 20,000 vehicles per day
- 9) peak period parking restrictions in direction of major flow
- 10) minimum width of forth (40) feet, preferable wider
- 11) good sight distance, flat grades and long curves
- 12) wide right-of-way

A typical other principal arterial is Rhode Island Avenue, N.E. It is six lanes wide with non-rush hour on-street parking and carries over 25,000 vehicles per day.



**Minor arterials** - These streets provide the connections between the principal arterial networks and may service major flows in an area with no clearly defined principal arterial street. The characteristics of streets in this classification are:

- interconnect with and augment the principal arterial network
- may function as a principal during the peak periods
- serve greater land use access than principals but access is subordinate to traffic movement
- average daily traffic is greater than 8,000 and less than 20,000 vehicles per day
- minimum of sharp grades and steep curves
- serve bus and truck movements
- may have peak period parking restrictions

A typical minor arterial is Piney Branch Road, N.W. which carries two lanes of traffic in the peak period and one lane at all other times. It carries 15,000 vehicles per day.

**Collectors** - These streets serve a variety of functions, including providing direct access to major traffic generators, i.e. a METRO station or a large complex of apartments. They may be a connection from a neighborhood to the arterial network or may provide a connection between arterial streets in an area where no clearly defined minor arterial is present to handle the connection. The characteristics of streets in this classification are:

- 1) serve a split function of land use access and traffic movement
- 2) collect and distribute traffic in residential and commercial areas
- 3) average daily traffic is greater than 2,000 and less than 8,000 vehicles per day
- 4) may provide direct access to a major traffic generator
- 5) serve local bus and commercial traffic
- 6) no peak period parking restrictions

A typical collector is Fort Lincoln Drive, N.E., which provides access into the Fort Lincoln New Town Development.

**Local streets** - These roadways provide direct access to abutting land use with a minimum of through traffic. Traffic volumes are less than 2,000 vehicles per day and bus and truck use is only to provide local service or delivery. By definition local streets comprise all streets not on a higher category.

### Procedure for Assigning Streets to a Particular Classification

The first two sub-categories of Principal arterials are defined by their construction. Both Interstate and Other Freeways are unique in their physical characteristics. They are controlled access facilities; that is, access to the roadway is usually by a ramp and/or an interchange. There are generally no intersections or traffic signals, no parking, or driveways to adjoining land use. The remaining classifications are comprised of city streets that are assigned to a category based on a combination of physical and operational characteristics. Each street is assigned after a review of the pertinent data for each section. The data includes street width, number of lanes, traffic volumes (both peak and off peak), bus routes, parking regulations, land use, and the relationship of the street with the regional and city roadway network. The classifications are based on use, and therefore existing travel patterns play a major role in the determination of the classification assigned. The data assembled for each street is compared to the desired characteristics for each classification (listed in previous section) and assignments are made accordingly.

**Use and extent of each system** - A primary goal in traffic planning is to accommodate as much traffic as practical on a minimum mileage of streets. The D.C. street systems' operation in this regard is demonstrated in Table 1, which details the proportional use of the street network by each functional classification.

**Table 1**

<u>Functional Classification</u>	<u>Miles/ (% of Total)</u>	<u>Proportion of Daily Traffic</u>
Principal Arterial	128 (12)	51 %
Minor Arterial	156 (14)	30%
Collectors	150 (14)	10%
Local Streets	668 (60)	9%

This demonstrates the effectiveness of the present system, as the Principal arterial network, which comprises only 12 percent of the roadway mileage, carries 51 percent of the traffic and the local street system which is the major portion of the D.C. network, carries less than 10 percent of the traffic in the City.

**Policy Regarding Changes to the Assigned Classification**

The Functional Classification of a street is not regarded as a permanent assignment or a rigid plan that must be maintained. It is only to be used as a framework for traffic planning. A tenet of the Department's transportation planning process is that no significant change can be effected on the operation of a street without due consideration of its effect on adjacent streets. For example, if a street is carrying a daily flow of 12,000 vehicles per day and is classified as a minor arterial, and the Department is requested by a citizen's group to reduce the vehicular flow and the classification, the response would not be that the street is an arterial and hence flow could not be restricted. The operation of the street in question and others in the area can be reviewed to determine if the traffic can be diverted to other roadways. If it can be diverted, and the measures to restrict traffic area implemented, the classification will be lowered to the appropriate level. If, however, it is determined that no restriction can be implemented without overloading an adjacent arterial or diverting traffic to local streets, the operation and classification must be maintained. Likewise, if the traffic volume on a street is increased due to a major development or other change in the area, the classification would be upgraded accordingly.



**APPENDIX B**

**TRAFFIC CONTROL PLAN GUIDELINES**

**GOVERNMENT OF THE DISTRICT OF COLUMBIA  
District Department of Transportation**



**TRAFFIC SERVICES ADMINISTRATION**

**TRAFFIC CONTROL PLAN (TCP) INSPECTION CRITERIA**

**7<sup>TH</sup> EDITION, March 21, 2005**

This document is prepared to provide users of approved Traffic Control Plans (TCPs) the criteria that the field implementation of their TCPs will be evaluated against the District Department of Transportation (DDOT) will periodically inspect work zones to ensure compliance, verify that safety measures are in place, and ascertain that the measures conform to the approved TCP and criteria listed below:

1. CONTRACTOR SHALL HAVE, AT ALL TIMES, COPIES OF THEIR TCPs & PERMIT ON SITE AND AVAILABLE FOR THE INSPECTOR'S REVIEW. UNLESS OTHERWISE AUTHORIZED BY DDOT, ANY PROJECT / CONTACTOR FAILING TO HAVE APPROVED PERMITS AND TCPs ON SITE, OR ANY CONTRACTOR FAILING TO FOLLOW THE APPROVED PLAN AND TCP, WILL BE SUBJECT TO FINES AND POSSIBLE IMMEDIATE SUSPENSION OF WORK.
2. ALL TRAFFIC CONTROL SHALL CONFORM TO PART VI OF THE 2003 EDITION MANUAL ON UNIFORM TRAFFIC CONTROL DEVICES (MUTCD) AND DDOT'S WORK ZONE MANUAL. ALL TRAFFIC CONTROL DEVICES SHOULD COMPLY WITH NCHRP 350 CRASH TESTING STANDARDS AND SHOULD HAVE MARKINGS OF COMPLIANCE ON THE STANDARDS.
3. THE CONTRACTOR SHALL MAKE CERTAIN THAT THE PERSON(S) RESPONSIBLE FOR THE IMPLEMENTATION OF THE TRAFFIC CONTROL PLAN HAS SUCCESSFULLY COMPLETED TRAINING IN TEMPORARY TRAFFIC CONTROL AND HIS OR HER NAME AND QUALIFICATIONS SHALL BE SUBMITTED PRIOR TO WORK COMMENCING. ACCEPTED CERTIFYING ORGANIZATIONS ARE ATSSA, MDOT, VDOT, OR EQUIVALENT.
4. ALL FIELD PERSONNEL SHALL WEAR SAFETY VEST, HARD HATS, AND OTHER REQUIRED PERSONAL PROTECTION EQUIPMENT.
5. CONTRACTOR SHALL PROVIDE FLAGGING OPERATIONS FOR CONDITIONS DEEMED NECESSARY BY SELF OR DDOT. ALL FLAGGERS MUST BE CERTIFIED AND HAVE THEIR CERTIFICATION CARD IN THEIR POSSESSION WHEN FLAGGING. THEY SHALL BE EQUIPPED WITH SAFETY VESTS, HARD HATS, HAND SIGNALING DEVICES, AND ELECTRONIC DEVICES FOR COMMUNICATION.
6. ALL FLAGGING OPERATIONS SHALL USE A "STOP"/"SLOW" PADDLE OF 24 INCHES IN DIAMETER MOUNTED ON A 6-FOOT POLE WITH 6-INCH SERIES "C" LETTERS.

7. CONTRACTORS SHALL NOT CLOSE MORE THAN ONE LANE OF TRAFFIC IN ONE DIRECTION UNLESS OTHERWISE APPROVED.
8. ARROW PANELS ARE REQUIRED FOR LANE CLOSURES ON MAJOR ARTERIALS AND MAY BE DEEMED NECESSARY ON OTHER ROADWAYS.
9. 36-INCH REFLECTIVE CONES ARE REQUIRED FOR MAINTENANCE OF TRAFFIC (MOT). TRAFFIC CONES ARE USED FOR DAYTIME WORK ONLY. 36-INCH REFLECTIVE DRUMS SHALL BE USED FOR TAPERS ON FREEWAY SYSTEM OR WHEN INDICATED BY DDOT. ALL TRAFFIC SAFETY DRUMS USED FOR THE MAINTENANCE OF TRAFFIC SHALL BE OF A LOW DENSITY MATERIAL.
10. TYPE III BARRICADES SHALL BE USED FOR ROAD CLOSURES. ADEQUATE ROAD CLOSURE AND DETOUR SIGNAGE SHALL BE INSTALLED TO GIVE MOTORIST GUIDANCE. DETOUR DIRECTION SIGNS MUST BE ACCOMPANED BY MESSAGE SIGNS THAT INDICATE DETOUR STREET NAME. DO NOT USE ABBREVIATIONS ON MESSAGE SIGNS.
11. ALL LEADING ENDS OF THE TEMPORARY CONCRETE BARRIERS EXPOSED TO ON-COMING TRAFFIC SHALL BE PROTECTED WITH PORTABLE IMPACT QUADGUARD TRAFFIC ATTENUATOR. ALL ATTENUATORS SHALL HAVE OBJECT MARKERS.
12. CONTRACTORS SHALL INSTALL "STEEL PLATE AHEAD" SIGNS WHENEVER PLATES HAVE BEEN INSTALLED.
13. TEMPORARY REFLECTIVE PAVEMENT TAPE OF THE APPROVED TYPE SHALL BE USED TO DESIGNATE TRAFFIC LANES. ALL MARKERS SHALL BE WHITE, EXCEPT FOR THE LEFT EDGE OF THE EFFECTIVE ROADWAY, WHICH SHALL BE YELLOW.
14. DAYTIME WORK HOURS ARE BETWEEN 9:30 A.M. - 3:30 P.M. OR AS APPROVED.
15. NIGHTTIME WORK HOURS ARE BETWEEN 7:30 P.M. - 4:30 A.M. OR AS APPROVED.
16. ADVANCE WARNING SIGNS SHALL BE 48 X 48 INCHES BLACK / ORANGE HIGH PERFORMANCE WIDE ANGLE RETRO-REFLECTIVE SHEETING. ROLL-UP SIGNS ARE APPROVED. HOWEVER SIGN SHEETING SHALL BE FLUORESCENT ORANGE AND SOLID NOT MESH.
17. CONTRACTOR SHALL USE AND ADJUST SPRING-LOADED SIGN STANDS UP SO MOTORIST CAN SEE AND READ SIGN. SIGN STANDS SHOULD COMPLY WITH NCHRP 350 CRASH TESTING STANDARDS AND SHOULD HAVE MARKINGS OF COMPLIANCE ON THE STANDS.
18. ALL TEMPORARY SIGNS SHALL BE PLACED IN APPROPRIATE PLACES, BE ADEQUATE FOR EXISTING STREET CONDITIONS, AND BE STABLE AND FIRMLY INSTALLED.
19. ALL CONSTRUCTION VEHICLES OPERATING IN AND AROUND THE WORK ZONE SHALL OPERATE STROBE OR REVOLVING LIGHTS AT ALL TIMES. THESE LIGHTS SHOULD BE MOUNTED IN SUCH A MANNER THAT THEY ARE VISIBLE 360 DEGREES.
20. NO HOMEMADE CONSTRUCTION, REGULATORY, OR GUIDE SIGNS SHALL BE ALLOWED.

21. DAMAGED, DIRTY, OR DEFACED DEVICES, INCLUDING SIGNS, CHANNELIZERS, AND TRAFFIC CONTROL EQUIPMENT ARE NOT APPROVED AND SHALL NOT BE USED.
22. ANY WORK THAT REQUIRES TEMPORARY NO-PARKING RESTRICTIONS FOR A CONTRACTOR TO PERFORM THEIR WORK SHALL REIMBURSE THE DISTRICT OF COLUMBIA ALL LOST REVENUE FOR ALL SPACES OCCUPIED IF THE NO PARKING ZONE AFFECTS PARKING METERS DURING THE LIFE OF THE WORK (CURBSIDE MANAGEMENT TELEPHONE NUMBER IS 202-671-2020).
23. IT SHALL BE THE CONTRACTOR'S RESPONSIBILITY TO RECORD METER NUMBERS AFFECTED BY THEIR WORK AND REPORT THOSE METERS OCCUPIED TO PARKING SERVICES.
24. ALL CONTRACTORS SHALL MAINTAIN PEDESTRIAN CROSSWALKS AND WALKWAYS WHETHER PAVED OR UNPAVED UNLESS OTHERWISE INDICATED ON THE PLANS AND APPROVED BY DDOT. TEMPORARY WHEELCHAIR RAMPS SHALL ALSO BE INSTALLED AND MAINTAINED BY THE CONTRACTOR OR AS DEEMED NECESSARY BY DDOT. **COMPLIANCE TO THE AMERICAN DISABILITIES ACT (ADA) IS REQUIRED.** CONTRACTORS INVOLVED IN WORK ON SIDEWALKS AND RAMPS, BE IT NEW CONSTRUCTION OR RENOVATION, NEED TO HAVE THE APPROPRIATE SIGNAGE PRESENT OFFERING SAFE AND COMPLIANT ALTERNATIVE ROUTES FOR THE DISABLED AND PEDESTRIAN TRAFFIC.
25. A CONTRACTOR WITH VEHICLES AND EQUIPMENT IN PUBLIC SPACE REQUIRES A PERMIT. ANY CONTRACTORS WHO WISH TO LEAVE EQUIPMENT OVERNIGHT IN PUBLIC SPACE ARE SUBJECT TO REEMBURSING THE CITY FOR THE SPACE BEING OCCUPIED. AND MUST HAVE A PERMIT ALLOWING OVERNIGHT STORAGE ON CITY STREETS OR IN CITY SPACE. ALL ITEMS PERMITTED TO BE STORED OVERNIGHT ON CITY STREETS OR IN CITY SPACE MUST BE SECURED AND MUST GIVE CONSIDERATION TO PUBLIC SAFETY. IN THE EVENT OF AN EMERGENCY, THE CITY RESERVES THE RIGHT TO REMOVE ALL ITEMS THAT ARE PERMITTED BY ANY MEANS NECESSARY. EMERGENCY CONTACT INFORMATION SHOULD BE PROVIDED TO DDOT WITH 24-HOUR ACCESS IN THE EVENT SUCH AN EMERGENCY OCCURS.
26. ANY CONSTRUCTION IN RESIDENTIAL AND OR HOTEL ZONES REQUIRES A DAYTIME WORK HOURS PERMIT UNLESS OTHERWISE APPROVED BY DDOT.
27. CONTRACTOR SHALL MAINTAIN ACCESS TO ALL DRIVEWAYS, GARAGES, ALLEYS, AND LOADING DOCKS AT ALL TIMES, AS WELL AS ACCESS TO ALL BUSINESSES.
28. CONTRACTOR MAY BE REQUIRED TO HIRE POLICE FOR PARKING AND WORK ZONE ENFORCEMENT.

29. CONTRACTOR SHALL NOTIFY APPROPRIATE ANC CHAIRPERSON AND RESIDENTS AND/OR MERCHANTS IN WRITING OF PLANNED WORK/TCP THREE WEEKS PRIOR TO STARTING DATE. THE CONTRACTOR WILL BE REQUIRED TO FURNISH DDOT WITH ALL LETTERS AND RESPONSES IN WRITING CONCERNING THEIR PROJECT. THIS DOES NOT APPLY TO CRANES THAT ARE USED FOR DURATION OF 1-2 DAYS.
30. THE CONTRACTOR IS REQUIRED TO NOTIFY FIRE AND / OR POLICE DEPARTMENTS OF APPROVED ROAD CLOSURES. PERMITS WITH THEIR APPROVAL MUST BE ON SITE WITH ALL OTHER PERMITS.
31. ALL TRAFFIC CONTROL DEVICES NOT IN USE SHALL BE REMOVED FROM THE PUBLIC SPACE OR AS DIRECTED BY DDOT. WHEN APPROVED BY DDOT ALL REGULATORY SIGNS MUST BE COVERED SECURELY TO AVOID MISINFORMATION.
32. PORTABLE CHANGEABLE MESSAGE SIGNS (PCMS) MAY BE REQUIRED TO GIVE THE MOTORING PUBLIC ADVANCE NOTIFICATION OF ROAD CONDITIONS, ROADWORK, AND/OR EVENTS. ARROW BOARDS MAY ALSO BE REQUIRED IN WORK ZONES TO AID IN LANE CLOSURES AND, WHERE WORK REQUIRES, A TRUCK MOUNTED ATTENUATOR (TMA) CAN BE REQUIRED AS WORK DICTATES.
33. CONTRACTORS SHALL INSTALL COVERED WALKWAYS AT LOCATIONS THAT DDOT DEEMS NECESSARY. CONTRACTOR MAY ALSO BE REQUIRED TO DEVELOP PROTECTED PEDESTRIAN PATHS AROUND THE WORK AREA THAT MAY PLACE PEDESTRIAN TRAFFIC IN THE ROADWAY TEMPORARILY. IN THIS SITUATION CONCRETE BARRIERS OR WATER-FILLED BARRIERS WITH STEEL RIBBING WILL BE REQUIRED FOR DDOT APPROVAL.
34. WHEN REQUIRED BY DDOT, THE CONTRACTOR MAY BE REQUIRED TO LOWER THE POSTED SPEED LIMIT IN THE WORK ZONE DURING THE LIFE OF THE PROJECT. ALL CHANGES TO REGULATORY SIGNS WILL BE INDICATED TO THE PUBLIC WITH THE ADDITION OF TWO ORANGE WORKZONE FLAGS, AND WHEN REQUIRED BY DDOT, A TYPE B LIGHT MAY BE NECESSARY.
35. "END CONSTRUCTION" AND "ROAD WORK AHEAD" SIGNS WILL BE REQUIRED AT THE ENDS OF THE WORK ZONE; THIS INCLUDES ANY STREETS AFFECTED THAT WILL LEAD INTO OR OUT OF THE WORK AREA.
36. CONTRACTORS FAILING TO USE APPROVED DEVICES REQUIRED OR REQUESTED BY DDOT WILL BE SUBJECT TO POSSIBLE FINES OR IMMEDIATE SUSPENSION OF WORK.
37. THE TEMPORARY SIGNS AND MARKINGS PLACED ADJACENT TO THE WORK ZONE SHALL BE CONSISTENT AND VISIBLE AT ALL TIMES.
38. DURING NIGHTTIME HOURS, THE WORK SITE SHALL BE MADE SAFE FOR TRAFFIC. WARNING SHALL BE PROVIDED BY INSTALLING ELECTRONICALLY ILLUMINATED TRAFFIC CONTROL DEVICES SUCH AS FLASHING ARROW PANELS AND WARNING LIGHTS. THESE DEVICES SHOULD BE USED IN CONJUNCTION WITH OTHER TRAFFIC CONTROL DEVICES, AND THEIR FLASHING SEQUENCE AND LIGHT INTENSITY SHALL MEET THE REQUIREMENTS CITED IN THE MUTCD. ALL TRAFFIC CONTROL DEVICES MUST BE REFLECTORIZED DURING NIGHTTIME HOURS.
39. THE CONTRACTOR SHALL COORDINATE HIS MAINTENANCE OF TRAFFIC WORK WITH OTHER CONTRACTORS AND UTILITY COMPANIES WORKING IN THE SAME



GENERAL LOCATION TO MAINTAIN CONTINUITY OF TRAFFIC FLOW AND MINIMIZE CONGESTION.

40. PARKING IS TO BE PROHIBITED IN THE WORK AREA. PARKING IS TO BE RESTRICTED 72 HOURS IN ADVANCE UNLESS THERE IS AN EMERGENCY.
41. THE CONTRACTOR SHALL GIVE 72 HOURS PRIOR NOTICE TO THE DDOT/TSA WHEN MAKING A CHANGE IN TRAFFIC FLOW PATTERNS.

If you have questions or need further information, please contact Traffic Services Administration at (202) 671-2710.

Our goal is a safe work zone. Thank you for your cooperation!

Associate Director, Chief Traffic Engineer  
DDOT Traffic Services Administration

**GOVERNMENT OF THE DISTRICT OF COLUMBIA  
District Department of Transportation**



TRAFFIC SERVICES ADMINISTRATION

**GENERAL  
TRAFFIC CONTROL PLAN (TCP) SUBMITTAL GUIDELINES  
(APPLICATIONS FOR PUBLIC SPACE PERMITS ONLY)**

**7<sup>TH</sup> EDITION, March 21, 2005**

This document provides guidance for Traffic Control Plan submissions so they may be approved in a timely manner. Missing or insufficient information will delay approval.

**APPROVAL:** If a Traffic Control Plan (TCP) or Maintenance of Traffic (MOT) Plan is submitted as part of a public space application to Public Space Management Administration (PSMA) without certification by a Traffic Control Technician (or stamped by a Professional Engineer registered in the District of Columbia), it will be reviewed by the Traffic Services Administration (TSA).

**COORDINATION:** DDOT expects the submitter to coordinate with PSMA and TSA on (a) the amount of public space needed for a project (b) ensuring coordination with adjacent projects (c) special events appropriate detour routing, and (d) adequate level of service for street operations.

**REVIEW:** TCPs shall be subject to review and verification by DDOT staff for conformance to submission requirements.

**SUBMISSION REQUIREMENTS:** The requirements for submission are based on the 2003 Manual on Uniform Traffic Control Devices, the 1996 and amended 2004 D.C. Specifications for Highways and Structures, (2004 Amendment can be found on DDOT's website), and the 2004 DDOT Work Area Traffic Control Manual. All items are commonly available to contractors and their engineers.

- Traffic Control Plan (TCP) must be tailored to fit contractor's specific situation.
- All traffic control shall conform to the standards set forth in 2003 Edition Manual on Uniform Traffic Control Devices (MUTCD) and 2004 DDOT Work Area Traffic Control Manual.
- All traffic control shall adhere to DDOT Standards Specifications for Highways and Structures the ("red book"). Refer to Section 104.02 Maintenance of Traffic, 614.02 PCC Barrier and 616.01 – 616.23 Traffic Control.

- Provide address of premise for which public space work is proposed.
- Provide Lot(s) and Square(s) number.
- Specify the **MUTCD sign number** and size of all temporary signs utilized on the MOT/TCP drawings.
- Specify North.
- Specify Names of all streets adjacent to Work Zone.
- Specify scope and sequence of work in narrative.
- Specify location and length of work zone (Advanced Warning Area, Transition Area, Buffer Area, Active Work Zone, and Termination Area).
- Specify duration of work.
- Specify schedule of work hours.
- Specify limits of work.
- Show advance warning area and location of the advance warning signs. The signs shall be located at proper intervals to inform motorists of what to expect.
- Specify direction of travel, number of lanes, lane widths, and posted speed limit.
- Provide all adjacent intersections of the street under construction or under utility work (independent of the area of the street under construction).
- Specify street geometry, median, curb and gutter lines, existing street dimensions, and orientations; existing location and width of right-of-way for the street under construction or utility work and its intersecting streets.
- Specify if parking is to be restricted and if bus zone will need to be relocated.
- Specify placement of all devices. [**Arrow board panels, signs, cones, drums, attenuators, barricades, etc.**]
- Specify spacing of devices. [Arrow board panels, signs, cones, drums, barricades, etc.]
- Specify taper and tangent lengths.
- Specify if turning radius will impact bus and trash truck turns.
- Orient traffic sign and device symbols with directions of traffic.
- Show work vehicle locations.
- Notes are encouraged.
- Show Key and/or Legend.
- Show existing pavement markings and proposed temporary pavement markings. Make distinction between them.

- Show all existing and proposed traffic control and parking signage.
- Waiver for cutting on **suspended streets** (streets that have been paved or resurfaced within the last five years) must be approved by Public Space Management Administration before applications are sent to Traffic Services Administration/Work Zone and Public Safety.
- Provide temporary handicap ramps, crosswalks, and signs to meet Americans with Disabilities Act (ADA) for all pedestrians within construction work zone area. *(NOTE: The entire handicap ramp including side flares must be located within a crosswalk. The minimum crosswalk has a 15-foot width. The top and bottom of a ramp must have a 5-foot clearance. Stop lines are located a minimum six feet before a crosswalk. Stop lines are 12 inches wide. If using a striped crosswalk, the stripes are two feet wide with 2-foot spacing and make stripes parallel to curb line of street. Edge lines are required on all crosswalks.)*
- Identify whether parking metered or residential permit parking (RPP) is restricted or unrestricted.
- Cannot place equipment of any type in a NO PARKING ANYTIME ZONE, NO STANDING OR PARKING ANYTIME, and NO STANDING OR PARKING METRO BUS ZONE.
- All required dimensions shall be shown on crane and dumpster applications
- If any prohibiting signs (Regulatory) are proposed (No Left Turn and No Right Turn, whether symbolic or text message), advance coordination with TSA must occur to ensure that adequate traffic movements are provided in the vicinity of the project site.
- Each plan page of all submissions must include the following statement, “*I certify that this plan conforms to the requirements set forth in the 2003 Edition Manual on Uniform Traffic Control Devices (MUTCD), the 2004 DDOT Work Area Traffic Control Manual and adheres to DDOT Standards Specifications for Highways and Structures,*” followed by an original signature. This requirement is exempted for submission with Professional Engineer stamp.

**TYPICAL TCPs FOR UTILITY WORK:** 21 typical TCPs for **utility work only** are available through the DDOT website in PDF format for use.

- When submitting DDOT typicals, make sure to specify street geometry, existing street dimensions, street names, etc. Each typical Traffic Control Plan drawing should contain the list of locations for which the TCP is applicable.
- Submit only those typicals that apply. The submitted typical TCPs should match real street conditions. Otherwise, submit MOT/ TCP individually by actual real street conditions and work zone location.

**INSPECTION:** DDOT reserves the right to periodically inspect work zones to ensure compliance, that safety measures are in place, and that the measures conform to the approved TCP and criteria listed on the Traffic Control Plan Inspection Criteria document.

Our goal is a safe work zone, thank you for your cooperation!

Associate Director, Chief Traffic Engineer  
DDOT Traffic Services Administration

**GOVERNMENT OF THE DISTRICT OF COLUMBIA  
District Department of Transportation**



TRAFFIC SERVICES ADMINISTRATION

**THIRD PARTY CERTIFIED  
TRAFFIC CONTROL PLAN (TCP) SUBMITTAL REQUIREMENTS  
(APPLICATIONS FOR PUBLIC SPACE PERMITS ONLY)**

**8<sup>TH</sup> EDITION, May 10, 2005**

This document provides a clear set of guidelines for the submission and approval of third party certified Traffic Control Plans (TCP).

**APPROVAL:** If a Traffic Control Plan (TCP) or Maintenance of Traffic (MOT) Plan is submitted as part of a public space application certified by a Traffic Control Technician (or stamped by a Professional Engineer registered in the District of Columbia) as meeting District Department of Transportation requirements of TCP, it will be approved at the time of submission to Public Space Management Administration (PSMA). The preparer will be expected to provide proof of training or registration – either a copy of the training certificate and certification card or a P.E. stamp/seal. Any person that becomes certified or is already certified (through ATSSA or any credible institution) must obtain a stamp (notary style) engraved with their Certification Number to stamp all TCPs.

Otherwise, TCPs submitted with permit applications will be reviewed using the process prior to the availability of this third party certified option.

**COORDINATION:** It is mandatory for applicants that use this system to set up an appointment with the Engineering Technician or Traffic Engineer of the Ward where the work is being performed to ensure that all issues are addressed and in compliance. This applies to projects that have demolition, excavation deeper than 20 inches, new structures, renovated structures, and any other projects that are deemed necessary by the District Department of Transportation (DDOT). The baseline for these projects are six (6) months or greater. Traffic Services Administration will also ensure that the amount of public space needed for a project is coordinated with adjacent projects, special events appropriate detour routing, and adequate level of service for street operations. Traffic Services Administration will designate all detours and truck routes for projects that need this type of service. Review and approval will be consistent with our motor carrier and truck restriction.

Cranes that are used for short-term work (one to two days for life threatening situations such as hoisting an AC and heating units, large medical equipment, etc.) are allowed to be hand carried to the Associate Director's Office at Traffic Services Administration for

login without first going to Public Space Administration because of the short turn-around of the work to be performed. Then the applicant can proceed to Public Space Administration to purchase permit(s). Also, this type of work does not need ANC notification.

No regulatory signs can be removed from the streets, and no traffic operation can be changed in the District of Columbia without DDOT's prior approval or authorization.

**REVIEW:** TCPs shall be subject to later review and verification by DDOT staff for conformance to submission requirements. This places a level of professional expectation on the submitter to certify that the TCP meets DDOT requirements.

Should the submitted TCP not conform to the submission requirements, DDOT reserves the following options:

- To add additional elements as conditions to the TCP to meet the requirements.
- To issue a stop work order pending the submitter revising and resubmitting their TCP consistent with requirements.

The following steps will be taken if a submitter does not comply with the submission requirements:

The following steps will be taken if a submitter does not comply with the submission requirements:

- On the first occurrence the submitter shall receive a warning of non-conformance.
- On the second occurrence within 18 months of the first occurrence, the submitter shall receive a letter of non-conformance and subsequently be required to have all submissions reviewed through the regular process by DDOT prior to approval.

Reinstatement to approve on submission will be based on the submitter's demonstrated understanding of the TCP submission requirements. Demonstration of understanding shall include the submission of six TCPs of less than 10 pages or two TCPs of 10 or more pages in conformance with the requirements.

**SUBMISSION REQUIREMENTS:** The requirements for submission are based on the 2003 Manual on Uniform Traffic Control Devices, the 1996 and amended 2004 D.C. Specifications for Highways and Structures, (2004 Amendment can be found on DDOT's website), and the 2004 DDOT Work Area Traffic Control Manual. All items are commonly available to contractors and their engineers.

- Traffic Control Plan (TCP) must be tailored to fit contractor's specific situation.
- All traffic control shall conform to the standards set forth in 2003 Edition Manual on Uniform Traffic Control Devices (MUTCD) and 2004 DDOT Work Area Traffic Control Manual.

- All traffic control shall adhere to DDOT Standards Specifications for Highways and Structures (the “red book”). Refer to Section 104.02 Maintenance of Traffic, 614.02 PCC Barrier and 616.01 - 616.23 Traffic Control.
- Provide Address of Premise for which Public Space Work is proposed.
- Provide Lot(s) and Square(s) number.
- Specify the **MUTCD sign number**, and size of all temporary signs utilized on the MOT/TCP drawings.
- Specify North.
- Specify Names of all adjacent streets to Work Zone.
- Specify scope and sequence of work in narrative.
- Specify location and length of work zone (Advanced Warning Area, Transition Area, Buffer Area, Active Work Zone, and Termination Area).
- Specify duration of work.
- Specify schedule of work hours.
- Specify limits of work.
- Show advance warning area, and location of the advance warning signs. The signs shall be located at proper intervals to inform motorists of what to expect.
- Specify direction of travel, number of lanes, lane widths, and posted speed limit.
- Provide all adjacent intersections of the street under construction or under utility work (independent of the area of the street under construction).
- Specify street geometry, median, curb and gutter lines, existing street dimensions, and orientations; existing location and width of right-of-way for the street under construction or utility work and its intersecting streets.
- Specify if parking is to be restricted and if bus zone will need to be relocated.
- Specify placement of all devices (**Arrow board panels, signs, cones, drums, attenuators, barricades, etc.**).
- Specify spacing of devices (Arrow board panels, signs, cones, drums, barricades, etc.)
- Specify taper and tangent lengths.
- Specify if turning radius will impact bus and trash truck turns.
- Orient traffic sign and device symbols with directions of traffic.
- Show work vehicle locations.
- Notes are encouraged.
- Show Key and/or Legend.



- Show existing pavement markings and proposed temporary pavement markings. Make distinction between them.
- Show all existing and proposed traffic control and parking signage.
- Waiver for cutting on **suspended streets** (**streets that have been paved or resurfaced within the last five years**) must be approved by Public Space Management Administration before applications are sent to Traffic Services Administration/Work Zone and Public Safety.
- Provide temporary handicap ramps, crosswalks, and signs to meet Americans with Disabilities Act (ADA) for all pedestrians within construction work zone area. *(NOTE: The entire handicap ramp including side flares must be located within a crosswalk. The minimum crosswalk has a 15-foot width. The top and bottom of a ramp must have a 5-foot clearance. Stop lines are located a minimum six feet before a crosswalk. Stop lines are twelve inches wide. If using a striped crosswalk, the stripes are 2-feet wide, with 2-foot spacing and make stripes parallel to curb line of street. Edge lines are required on all crosswalks.)*
- Identify whether parking metered or residential permit parking (RPP) is restricted or unrestricted.
- Cannot place equipment of any type: in a NO PARKING ANYTIME ZONE, NO STANDING OR PARKING ANYTIME, and NO STANDING OR PARKING METRO BUS ZONE.
- All required dimensions shall be shown on crane and dumpster applications
- If any prohibiting signs (Regulatory) are proposed (No Left Turn and No Right Turn, whether symbolic or text message), advance coordination with TSA must occur to ensure the adequate traffic movements are provided in the vicinity of the project site.
- Each plan page of all submissions must include the following statement, “*I certify that this plan conforms to the requirements set forth in the 2003 Edition Manual on Uniform Traffic Control Devices (MUTCD), the 2004 DDOT Work Area Traffic Control Manual and adheres to DDOT Standards Specifications for Highways and Structures,*” followed by an original signature. This requirement is exempted for submission with Professional Engineer stamp.

**TYPICAL TCPs FOR UTILITY WORK:** 22 typical TCPs for **utility work only** are available through the DDOT website in PDF format for use.

- When submitting DDOT typicals, make sure to specify street geometry, existing street dimensions, street names, etc. Each typical Traffic Control Plan drawing should contain the list of locations for which the TCP is applicable.
- Submit only those typicals that apply. The submitted typical TCPs should match real street conditions. Otherwise, submit MOT/ TCP individually by actual real street conditions and work zone location.

**INSPECTION:** DDOT reserves the right to periodically inspect work zones to ensure compliance, ascertain that safety measures are in place, and that the measures conform to the approved TCP and criteria listed on the Traffic Control Plan Inspection Criteria document.

Our goal is a safe work zone, thank you for your cooperation!

Associate Director, Chief Traffic Engineer  
DDOT Traffic Services Administration

**APPENDIX C  
TYPICAL WORK ZONE AND CRANE SET UP PHOTOS**



Center Lane Closure

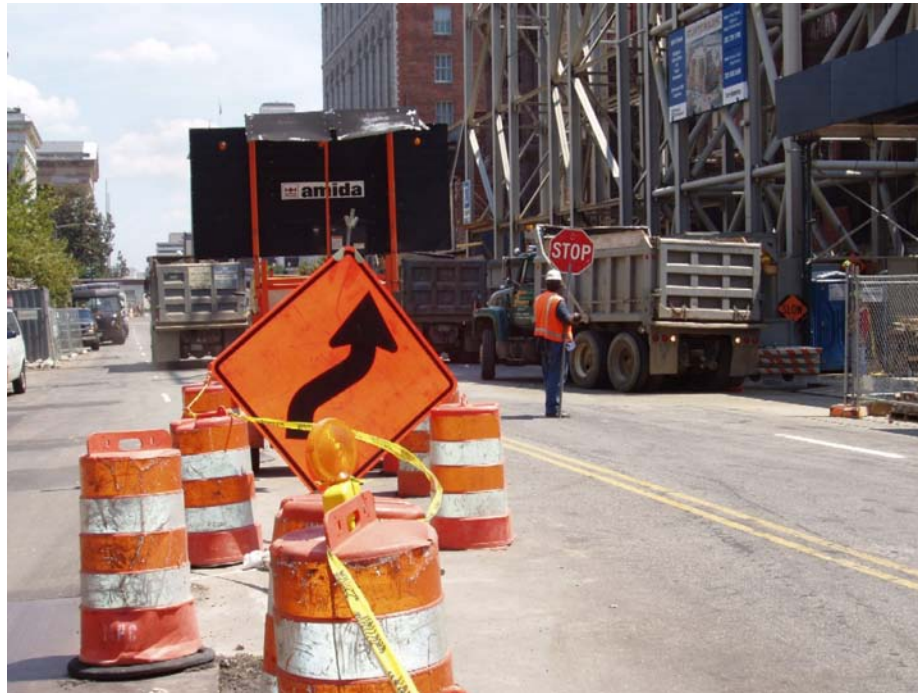

Flagman and Lane Shift



Freeway Work Zone



G Street Closure – Crane Operation - 1



G Street Closure – Crane Operation – 2



G Street Building Construction  
(DO NOT USE ENGINEER GRADE SIGN AS ILLUSTRATED)



I Street – Partial Closure – Crane Operation – 1



I Street – Partial Closure – Crane Operation - 2



I Street – Partial Closure – Crane Operation – 3



Keep Right Sign





**APPENDIX D**

**KEY TELEPHONE NUMBERS**

Police, Fire or Medical Emergencies	911
D.C. Emergency Management	202-727-6161
Police Non Emergencies	311
MPD Command center (24/7 line for reporting suspicious activities)	202-727-9099
Mayor’s City Wide Call Center	202-727-1000
WASA (Washington Sewer Authority Emergency Number	202-612-3400
Washington Gas (Natural Gas Emergency Number)	703-750-1400
PEPCO (Life Threatening Emergencies)	202-872-3432
Department of Homeland Security	1-800-BE-READY
Verizon Safety Environment Hotline	1-800-386-9539
“Miss Utility”	1-800-257-7777

Washington Gas	202-546-7650	Gas main and service
Verizon	202-575-8004	Safety Hotline
PEPCO	202-833-7500	Electric conduits and cables
WMATA (Metro) Office of Engineering and Architecture	202-962-1166	Office of Chief Engineer
DDOT	202-698-3607	Field Operations
DDOT	202-645-7050	DDOT neighborhood infrastructure maintenance office
DDOT	202-269-0855	Street lighting
DDOT	202-671-1486 202-671-1487	Traffic signal malfunction reporting
DDOT	202-671-1352	Traffic counting
GSA	202-557-9034	Steam piping, steam tunnel and condenser water conduit
DDOT	202-671-DDOT	
Emergency Management Administration (EMA)	202-727-6161	

Note that these numbers have been provided for convenience only. The contractor has the ultimate responsibility of contacting the agency.



**Works Cited**

- 
- <sup>i</sup> U.S. Department of Transportation. Federal Highway Administration (FHWA) *Manual on Uniform Traffic Control Devices: 2003 Edition*. November 2004. Washington D.C.:n.p
- <sup>ii</sup> U.S. Department of Transportation. Federal Highway Administration (FHWA). *Final Rule on Work Zone Safety and Mobility Brochure: Federal Register* (69 FR 54562) .September 2004. Washington D.C
- <sup>iii</sup> American Association of State and Highway Transportation Officials (AASHTO), *Roadside Design Guide:3<sup>rd</sup> Edition*. March 2002. Washington D.C
- <sup>iv</sup> U.S. Department of Transportation. Federal Highway Administration (FHWA) *Standard Highway Signs: 2004 Edition*. Washington D.C.:n.p
- <sup>v</sup> American Traffic Safety Services Association (ATSSA), *Quality Standards for Work Zone Traffic Control Devices Brochure: 1992*:n.p.



**NOTES**

